

Tableau Project Expert





Contents

- Using Tableau Blueprint 15
 - Organizations 15
 - Teams 16
 - Individuals 17
- Tableau Blueprint Overview 19
 - Core Capabilities of Data-Driven Organizations 20
 - Agility 21
 - Proficiency 22
 - Community 23
 - Governed and Trusted Data 24
- A Repeatable Process for Tableau Blueprint 25
 - Step 1: Discover 25
 - Step 2: Govern 26
 - Step 3: Deploy 26
 - Step 4: Evolve 26
- Analytics Strategy 27
 - Discovery Process 27
 - Analytics Vision 28
 - Case Study: Setting a Vision for the Superstore HR Data and Analytics Team 30
 - Business Value 33
 - Business Value Example: Superstore HR Data and Analytics Team 36
- Tableau Roles and Responsibilities 36
- Tableau Enterprise Architecture Survey 36
 - Tableau Server 37
 - Tableau Cloud 39

CRM Analytics	41
Tableau Data and Analytics Survey	42
CRM Analytics Predictions Survey	44
Tableau Use Cases and Data Sources	45
Use Cases	46
Ideas for Initial Use Cases	46
Tableau Data and Content Governance	48
Data Governance	48
Content Governance	51
Tableau Education Role Mapping	53
Current State Definition	54
Future State Definition	54
License Types	54
Education Role	55
Tableau Users	56
Tableau Community Planning	56
Tableau Upgrade Planning and Process Checklist	58
Software Upgrade Plan	58
Communication Plan	60
Education Plan	60
Support Plan	61
Tableau Project Planning	61
Planning Areas	61
Project Metrics	66
Executive KPIs	66
IT KPIs	66
Analytics KPIs:	67

- Line-of-Business KPIs 67
- Executive Advocacy and Project Team 69
 - Executive Sponsor Roles and Responsibilities 69
 - Tableau Project Team Roles and Responsibilities 72
 - IT/BI Professional Roles 73
 - Tableau Administrator Roles 75
 - Tableau Content Creator Roles 76
 - Tableau Content Consumer Roles 77
- Tableau Governance 79
 - Modern Analytics Workflow 80
 - Governance in Tableau 81
 - Data Governance in Tableau 82
 - Data Source Management 82
 - Data Quality 85
 - Enrichment & Preparation 87
 - Data Security 89
 - Metadata Management 91
 - Monitoring & Management 95
 - Data Governance Summary 96
 - Content Governance in Tableau 97
 - Content Management 98
 - Projects 98
 - Sandbox and Certified Projects 99
 - Collections 101
 - Personal Sandbox 101
 - Sites 102
 - Authorization 103

Content Validation	109
Content Promotion	109
Content Certification	111
Content Utilization	112
Content Governance Summary	113
Tableau Governance Models	114
Centralized	115
Delegated	115
Self-Governing	115
Tableau Deployment	117
Tableau Platform Architecture	118
Tableau Server	118
Tableau Cloud	119
Hardware Platform	120
Hardware requirements	120
Initial Sizing	121
Scalability	122
Server Environments	122
High Availability	123
Disaster Recovery	125
Authentication and Authorization	126
Identity Store	126
Authentication	127
Authentication in Tableau Cloud	127
Tableau Cloud Multi-Factor Authentication Requirement	128
Authentication in Tableau Server	128
Active Directory & OpenLDAP	128

SAML	129
Trusted Tickets	131
Mutual SSL	132
Authorization	132
Network Communication	133
Tableau Server	133
Secure On-Prem Servers	134
Tableau Cloud	134
Network Topologies	134
Data Strategy	135
Tableau's Hybrid Data Architecture	136
Live Connection	136
In-Memory Extract	136
Query Federation	137
Data Server	137
Certified Data Sources	138
Data Security	138
Move Tableau to the Cloud	140
Considerations for Migrating from Tableau Server to Tableau Cloud	141
Should You Migrate from Tableau Server to Tableau Cloud?	141
Information Security Compliance	142
Data Source Type/Location	142
User Authentication	143
Tableau Cloud Multi-Factor Authentication Requirement	143
Custom Repository Views	143
Tableau Licensing	143
Complex Tableau Server Environment	144

How Do You Migrate from Tableau Server to Tableau Cloud?	144
Self-Migrate to Tableau Cloud	144
Engage Tableau Professional Services or a Migration Partner	145
	146
Considerations for Migrating Tableau Server to a public cloud	146
Migration Process	147
Architecture	147
Networking	148
Data Connectivity	148
Tableau Licensing	148
More Resources	149
Tableau Data Management	149
What is Tableau Data Management?	149
Tableau Catalog	150
Tableau Prep Conductor	152
Virtual Connections	154
When are virtual connections useful?	154
Data Policies	156
When are data policies useful?	156
Tableau Advanced Management	157
Advanced Management for Tableau Server	158
Configuration Management	158
Disaster Recovery	159
Workload Management	160
Monitoring & Chargebacks	160
Content Management	161
Advanced Management for Tableau Cloud	162

- Understand your environment 163
- Manage content at scale 164
- Enhance security 165
- Scale for your enterprise 167
- Data Science Integration 167
- Extensibility 168
 - REST API 168
 - Hyper API 168
 - Web Data Connector 169
 - JavaScript API 169
 - Extensions API 169
 - Document API 170
 - TSM API 170
 - Metadata API 170
 - Mobile App Bootstrap 170
 - Webhooks API 171
- Tableau License Types 171
 - Tableau Creator 171
 - Tableau Explorer 172
 - Tableau Viewer 173
- Tableau License Management 173
 - Login-Based License Management 174
 - Grant Role on Sign In 174
- Tableau Bridge Deployment 175
 - Management models 176
 - Centralized management 176
 - Mixed management 176

Tableau Desktop and Tableau Prep Builder Deployment	178
Tableau Mobile Deployment	178
Tableau Mobile App Distribution	179
Securing Mobile Data	179
Sign-in Seamlessly	180
Configure Offline Access	181
Rollout and Support	181
Tableau Support Programs	181
Tableau Monitoring	183
Monitoring Roles and Responsibilities	184
Hardware Monitoring	186
Tableau Server	187
Tableau Cloud	188
Built-in Alerts	189
Tableau Server	189
Tableau Cloud	190
Resource Monitoring Tool Incidents	190
Tableau Server Process Status	191
Administrative Views for Monitoring	192
Default Administrative Views	195
Custom Administrative Views	197
Tableau Accelerators	198
Secure On-Prem Servers	198
Troubleshooting	199
Tableau Server	199
Tableau Cloud	200
Tableau Maintenance	201

Tableau Server	201
Tableau Cloud	202
User Provisioning and Group Synchronization	203
Tableau Server	203
Tableau Cloud	203
Back-up and Restore	203
Database Maintenance	204
Load Testing	204
Capacity Planning	205
Resource Management	206
Stale Content Audit	206
Size Audit	207
Load Time Audit	207
Upgrades	207
Version Compatibility	207
Communicating the Upgrade	208
Software Upgrade Process	209
Tableau Education	215
Data Literacy	215
Skills by Tableau Education Role	217
Enable a data culture in your organization	217
Executive Sponsor	218
Community Leader	218
Data Steward	219
Provide insights and develop visualization solutions	219
Consumer	219
Author	220

Designer	220
Analyst	220
Data Scientist	221
Developer	221
Deploy and manage Tableau	222
Site Administrator	222
Server Administrator	222
Server Architect	223
Skills by Tableau License Type	223
Tableau Creator Skills	223
Tableau Explorer Skills	224
Tableau Viewer Skills	225
Developing a Tableau Education Plan	225
Learning Paths	226
Education Resources	227
Accountability and Reward Systems	228
Skill Badges	228
Certification	228
Skill Belts	230
Gamification	231
Volunteer Recognition	231
Measurement of Tableau User Engagement and Adoption	233
Measurement Roles and Responsibilities	234
Administrative Views for Measurement	235
Tableau Content Utilization	238
Tableau User Engagement	242
Login Frequency	242

- Days Since Last Login 243
- Subscriptions & Alerts 244
- Community Engagement 244
- Content Size and Performance 245
 - Tableau Accelerators 248
- Compliance 248
- Analytics Best Practices in Tableau 251
 - Why Visual Analytics? 251
 - Pre-attentive Attributes 251
 - Explaining Visual Encoding 252
 - The Cycle of Visual Analysis 255
 - Start with Questions 256
 - Get Data 256
 - Choose Visual Mapping 257
 - View Data 257
 - Develop Insights 258
 - Act (Share) 258
- Visual Best Practices 259
 - Audience 259
 - Context 259
 - Chart Choice 260
 - Layout 262
 - Color 263
 - Titles & Subtitles 263
 - Tooltips 264
 - Fonts 266
 - Dashboard Size 267

Dashboard Interactivity	268
Designing for Performance	269
Accessibility	270
Organizational Assets	271
Visual Style Guide	271
Dashboard Layout Template	272
Dashboard Review Checklist	272
Metadata Checklist	273
Presentation Guidelines	273
Tableau Communications	277
Tableau Enablement Intranet	277
Getting Started	278
FAQ	279
Support	279
Announcements	280
User Directory	280
Governance Models	280
Data Platforms	281
Certified Data Source Directory	281
Analytics Best Practices	281
Visual Style Guide	281
Inspiration	282
Events Calendar	282
Learning Plans	282
Data Literacy Resources	282
Company Education Calendar	283
User Group Recordings	283

- Internal Tableau Blog and Newsletter 283
- Tableau Discussion Forums and Chat 283
 - Getting Started 284
 - Building Your Forum 284
 - Chat 285
 - Learn from Tableau 285
- Tableau Community Engagement 287
 - Internal Tableau Activities 287
 - Tableau User Group 288
 - Tableau Champions Group 289
 - Tableau Admin Group 290
 - Tableau Lunch & Learn 291
 - Tableau Viz Games 291
 - Tableau Day 292
 - Analytics Day 292
 - Tableau Blitz 292
 - External Tableau Activities 293
 - Area Tableau User Group 293
 - Virtual Tableau User Group 293
 - Tableau Public Virtual Challenges 294
 - Tableau Community Forums 294
 - Tableau Conference 295
 - Iron Viz Competition 295
- Tableau Support Processes 297
 - Tableau Champion Development 298
 - Data Champions Program Foundations 298
 - Designing a Data Champions Program 299

Defining Champions	300
Developing Champions	300
Rewarding Champions	300
Running a Data Champions Program	301
Branding your program	301
Identifying Champions	301
Running Your Program	301
Peer-to-Peer Assistance	302
Mentoring	302
Tableau Discussion Forums & Chat	302
Tableau Data Doctor	303
Before getting started	303
Data Doctor Benefits	304
Data Doctor Toolkit Overview	304
External Tableau Community Forum	305

Using Tableau Blueprint

People are using data every day in their personal lives to make better decisions—from what route to take, to monitoring diet and exercise, and managing the personal budget. Think about that—almost everybody uses some kind of data already to gain efficiency, measure progress, and modify behaviors for better individual outcomes, whether they consciously realize it or not.

But making data ubiquitous in your organization or team is not so easy. You have to deeply understand where people need data and how they will use it, then make the relevant data accessible at those moments. Everyone says that they would like to be a data-driven organization, but the reality is that most companies are still in the early stages of modern data and analytics adoption.

With its prescriptive, proven, and repeatable processes, Tableau Blueprint curates the best practices and expertise of thousands of customers to help you, your team, and your organization become more data-driven. You will find a summary of the methodology in the [Tableau Blueprint Overview on page 19](#) topic, which we recommend for everyone to understand.

Depending on the scope, size, and maturity of your initiative, specific areas of Tableau Blueprint are more appropriate for your specific requirements. This topic provides relevant starting points for organizations, teams, and individuals.

Organizations

For most organizations, it is rare to begin with a clean slate. Likely, you'll find numerous existing ways of distributing and consuming data: some designated analysts who create reports for others, people using different business intelligence platforms and tools, the movement of data from governed systems of record to ungoverned methods for downstream analysis, and/or pockets of Tableau scattered across different teams that have grown separately over time.

The discovery process outlined in Tableau Blueprint will help you gather valuable perspectives from across the organization to define your [Analytics Strategy on page 27](#) with the [Tableau Blueprint Planner](#). This downloadable resource steps through the questions to ask, the plans to make, and the steps to take, helping you to accelerate your timeline for deploying with agility, building analytics proficiency, and creating an analytics community, while avoiding the common pitfalls that are encountered with trial and error alone. You will define [Governance in Tableau on page 81](#) to enable access to trusted data.

The better you understand your organization's requirements, the better you can proactively support the growth of analytics and the broad use of trusted and governed data. For both new and existing deployments, understanding the current state is the critical first step in developing your broader roll-out plan. This will help drive towards organizational alignment and identify the roles and responsibilities for the [Executive Advocacy and Project Team on page 69](#) to support the initiative from its beginnings through the planned expansion to users of all skill levels in your company.

Whether your organization is new to modern analytics or you've already deployed and need to broaden, deepen, and scale the use of data, Tableau Blueprint allows you to zoom out to see the big picture of what's ahead, and it allows you to zoom in on a specific area to fine tune and improve at any point along your journey.

Teams

For smaller teams or workgroups that are not part of a company-wide initiative, it is important to understand how data is used today and what analytical skills exist among your people. Your initial focus will be on identifying and prioritizing content, curating trusted and governed data sources, authoring impactful dashboards, creating models and deploying predictions, and building new skills.

Within the [Tableau Blueprint Planner](#), you will find the [Tableau Data and Analytics Survey on page 42](#) and [Tableau Use Cases and Data Sources on page 45](#) tabs to help you gather information you need to begin. They're also a great place to start if you are working towards proving value and obtaining executive sponsorship for a broader organization-wide effort. [Governance in Tableau on page 81](#) will help you establish a flexible, yet defined governance framework and right-size it for your unique requirements in Tableau Server or Tableau Cloud.

At the same time, building data literacy and growing analytical skills through education will be needed. The [Skills by Tableau Education Role on page 217](#), [Skills by Tableau License Type on page 223](#), and [Developing a Tableau Education Plan on page 225](#) topics will help your team build proficiency. The [Tableau Learning and Community \(TLC\) Guide](#) helps users determine which learning path is best for them based on how they use Tableau in their day-to-day job function.

For teams from large to small, start meeting together to share your knowledge and insights. This will be the beginning of your [Internal Tableau Activities on page 287](#). In addition, you should encourage your team to join the [Tableau Community](#) and participate in a thriving, global network

of data enthusiasts. For more information, see [External Tableau Activities on page 293](#) from regional and virtual Tableau User Groups to the annual Tableau Conference.

Individuals

Individuals will benefit from the prescriptive learning paths defined in [Skills by Tableau Education Role on page 217](#), such as Designer, Analyst, Data Scientist and Business Scientist, and Developer. Tableau Blueprint also provides a view of skills by license in the [Skills by Tableau License Type on page 223](#) topic. The [Tableau Learning and Community \(TLC\) Guide](#) helps users determine which learning path is best for them based on how they use Tableau in their day-to-day job function.

The [Analytics Best Practices in Tableau on page 251](#) topic provides guidelines, standards, and processes for the discovery, interpretation, and presentation of data. This will help you understand [The Cycle of Visual Analysis on page 255](#) and how to apply it to your data.

You should join the [Tableau Community](#) and participate in a thriving, global network of data enthusiasts. For more information, see [External Tableau Activities on page 293](#) from regional to virtual activities to the annual Tableau Conference.

Tableau Blueprint Overview

The importance of data to the modern enterprise is no longer a topic of debate. The sheer volume of data that organizations capture, store, and organize continues to grow at a staggering pace. In an age of data, suddenly, every company is a data company. Although the transformational potential of data is practically limitless, most companies still struggle to fully realize the value of their data. So how do you transform into a data-driven organization?

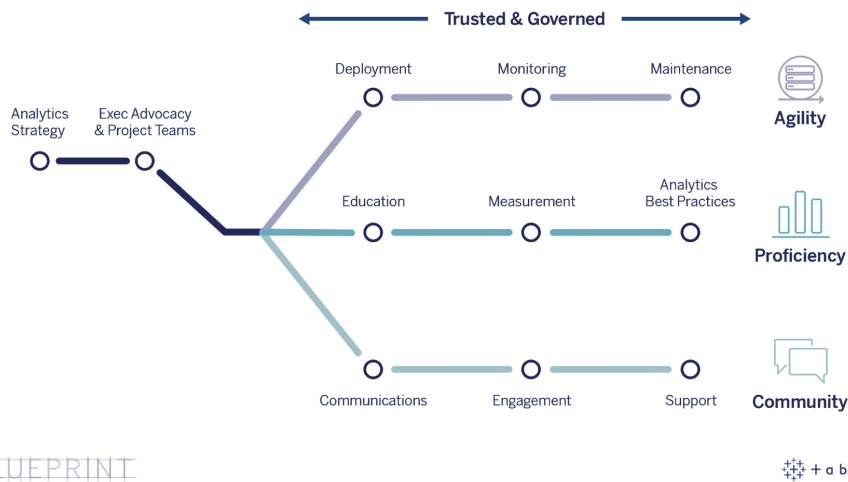
Tableau is the trusted standard in modern analytics and business intelligence platforms, enabling your entire organization to work smarter in its seamless end-to-end experience. Tableau provides powerful and intuitive analytics for users of all skill levels while integrating with your existing technology investments. This also includes Tableau Business Science which brings powerful data science capabilities to business people by introducing a new class of AI-powered analytics that puts data science techniques in the hands of business people, helping them make smarter decisions, faster.

Realizing the full value of your data means empowering everyone to make better decisions with it, and this cannot be done simply by choosing the right technology. As you chart your course to becoming a data-driven organization with Tableau, it's important to remember that you are not just deploying software—you are driving organizational transformation by prioritizing facts over intuition with data at the center of every conversation. Your decisions should not only give people the right tools, but they must also enable the development of new skills, create new behaviors, encourage participation, and recognize achievements to alter how the organization uses data every day.

Driving change across your organization requires effort and coordination of multiple stakeholders and users with different and sometimes opposing—yet valuable—viewpoints and interests. Orchestrating change, and doing it efficiently, requires executive advocacy, as well as alignment and participation from a broad set of cross-functional participants to ensure the needs of the entire organization are being met.

Tableau Blueprint is a step-by-step guide to becoming a data-driven organization, whether your organization is new to modern, self-service analytics or you've already deployed and need to broaden, deepen, and scale the use of data. Transforming how your company makes decisions every day is no easy task, but incorporating data and analytics into decision-making cycles is how you will see the most transformative impact on your organization. Achieving that level of transformation requires a deliberate and holistic approach to developing your analytics practice.

Although every organization's journey to developing a **Data Culture** will differ, Tableau Blueprint outlines the processes and best practices from thousands of customers.



This topic explains the core capabilities, the repeatable processes to empower more people to make data-driven decisions, and how to build a thriving data-driven mindset throughout your organization.

Core Capabilities of Data-Driven Organizations

At the heart of every data-driven organization, you will find three core capabilities—agility, proficiency, and community. The three capabilities are supported by organizational intent, change management, and trust.

A consistent approach to governance establishes guardrails around data and content security, access, and processes, allowing you to create a trusted and secure analytics environment for every department, team, and person in the organization. Governance is central to all successful self-service analytics initiatives, and it will help your organization start, grow, and evolve the use of data and analytics.

Scaling these efforts also means measuring and proving their impact on the enterprise's transformational goals with data and analytics. This means understanding which metrics best capture the cumulative impact of your iterative deployments, governance practices, increasing analytical skillsets, and community growth. Suitable metrics—especially for measuring

behavioral changes—will vary for each organization, and should be evaluated at regular intervals as analytics practices evolve.



Agility

Deployments must possess agility and provide choice and flexibility to meet your technology needs today, as well as adapt to where they go in the future. For on-premises and public cloud deployments of Tableau Server, you should operate on iterative, repeatable processes that begin with establishing a baseline architecture for a secure, stable, and trusted server platform. Given that analytics become mission-critical, agile deployments with proactive monitoring will maintain sufficient availability, capacity, and headroom while minimizing resource contention. Because modern BI platforms often see fast growth, you will need to assess server utilization and user engagement—and likely even change your topology—more frequently than with other enterprise technology platforms in order to remain responsive to the increased use of data and analytics. Alternatively, you may choose Tableau Cloud, the fully-hosted, SaaS analytics solution where Tableau scales and maintains the platform. Additionally, CRM Analytics is a fully SaaS hosted solution that is available as part of Salesforce cloud offerings.

This workstream is focused on deployment, monitoring, and maintenance, which are typically IT-led efforts that rely heavily on understanding the broader business strategy and requirements.

- **Deployment** — Both Tableau Server (on-premises or public cloud) and Tableau Cloud (fully-hosted SaaS) leverage your existing technology investments and integrate into your IT infrastructure to provide a self-service, modern analytics platform for your users. For Tableau Server, your systems administrator along with the Tableau Server Administrator will install and configure. For Tableau Cloud, you will work with select IT roles to integrate. A desktop administrator will deploy client applications to licensed users of Tableau Desktop and Tableau Prep Builder. For CRM Analytics, deployment is typically led by the Salesforce Administrator. For mobile use cases, Tableau Mobile can be published to your organization's

mobile device management solution. [Tableau Deployment on page 117](#) walks through the entire installation & configuration process and provides best practices along the way.

- **Monitoring** — Data is critical to doing analytics at scale. Ongoing, proactive hardware and application monitoring are required to deploy and operate Tableau Server and meet business requirements and performance expectations of your user community. Without monitoring, a “set it and forget it” mentality will likely be met with inadequate resources that fail to support the workload of highly-engaged users. Administrators should work together to ensure performance and stability of the platform to meet evolving business needs. For Tableau Cloud, it is critical to understand job status for data refreshes, site size, and licenses. Likewise, for CRM Analytics, it is critical to monitor data jobs in Data Manager and predictions in Model Manager to maintain data refreshes, the accuracy of models, and view any potential alerts or warnings. For more information, see [Tableau Monitoring on page 183](#).
- **Maintenance** — Regular maintenance activities will keep your Tableau deployment running in top condition. For Tableau Server, you will operationalize change management processes to support the increased use of analytics, including performance tuning, load testing, capacity planning, and server upgrades. Monitoring data will be the driver behind many maintenance decisions. For both Tableau Server and Tableau Cloud, you will plan client and mobile software upgrades. For CRM Analytics, upgrades are performing automatically in alignment with the Salesforce release schedule. [Tableau Maintenance on page 201](#) outlines activities and tools to keep your deployment in optimal condition.

Proficiency

For people to skillfully analyze data that's relevant to their jobs to make decisions that drive the business forward, they must develop proficiency. Beyond data capabilities, this also means employees actively seek using data over decision-making by instincts or feelings. Maximizing analytics investments and capitalizing on the transformative potential of data means that everyone encountering it—regardless of skill levels and data fluency—must be able to turn data into insights.

This workstream is focused on user education, measuring adoption and engagement, and increasing data fluency within your organization through best practices.

- **Education** — To integrate modern analytics into the fabric of your company, it's essential to build a scalable and ongoing learning plans for all your users by evaluating their relationship to data. [Tableau Education on page 215](#) will help you design and build the right education programs for your organization.

- **Measurement** — Similar to the monitoring requirements to achieve agile deployment, measurement helps Tableau Site Administrators understand user behaviors, such as who is creating and consuming content, which is important for managing and growing your team's use of analytics. For more information, see [Measurement of Tableau User Engagement and Adoption on page 233](#).
- **Analytics Best Practices** — Enable your users with the Cycle of Visual Analysis and repeatable processes to author, share, analyze, and collaborate, then extend it with your own organizational standards. For more information, see [Analytics Best Practices in Tableau on page 251](#).

Community

Community creates a network of users within your organization who use data to share and collaborate. This will continue to drive adoption and learnings around analytics and the insights they discover. The community leader will coordinate efforts to document enablement resources, connect users within your company, and generate enthusiasm among a group of people founded on the common cause of putting data at the center of every conversation. Internal user communities also benefit from integration with and support from the broader, global Tableau Community.

This workstream is focused on enabling user growth and evangelizing analytics through communications, engagement activities, and support.

- **Communications** — Establishing internal communications and user enablement resources promotes adoption to scale data and analytics more efficiently by guiding their learning and usage. [Tableau Communications on page 277](#) outlines how to build strong communication channels, including an enablement intranet, analytics blog/newsletter, and discussion forums/chat.
- **Engagement** — While building excitement around the use of Tableau, engagement activities accelerate and reinforce the vision for modern analytics, and ultimately, fuel your organizational transformation. Engagement activities are used to create and nurture an environment for more productive, results-driven people. [Tableau Community Engagement on page 287](#) defines types of activities to cultivate a thriving user community, including the internal user group meetings, knowledge transfer sessions, and competitions, as well as external community activities.
- **Support** — As your user base grows, it is critical to put the appropriate processes in place to efficiently and effectively support the user base. [Tableau Support Processes on page 297](#)

defines the ways to support users with traditional helpdesk support requests, Data Doctor, champion development, and mentoring.

Developing a comprehensive plan and approach for each of the topics within these three workstreams will ensure that you are taking a holistic approach to accelerate company-wide adoption of data and analytics.

Governed and Trusted Data

Governance is the combination of controls, roles, and repeatable processes that create trust and confidence in data and analytics within your organization. In a traditional BI environment, governance is often seen as a way to restrict access or lock down data or content. Because it is commonly associated with traditional BI processes, there is a common misconception that governance runs counter to a self-service, modern analytics environment; however, governance takes on a different, yet equally important role in a modern analytics environment—where governance enables and empowers your people, rather than restricts them.

Simply put, governance makes self-service analytics possible. It provides the guidelines and structure needed to properly protect data and content, but also provides the permissions and access needed for a self-service environment to be successful. For this reason, a clearly defined governance framework is the anchor point of every data-driven company. The governance models you define will drive many decisions throughout the process—from providing the guidance necessary for the three workstreams to move forward, to developing the core capabilities to strengthen the data-driven decision-making in your organization.

For self-service analytics to scale, governance needs to be collaborative. Both IT and business stakeholders on the project team are responsible for defining data and content governance. Shifting from an IT-led governance model does not mean IT relinquishes control so much as it means allowing the business to be more self-reliant within a trusted environment. Modern BI environments are implemented and scaled to benefit analysts and business users and as such, these users should all participate in maintaining its overall quality, including becoming a first line of defense in identifying data issues or irregularities within the agreed-upon governance models.

Acknowledging that every organization is different, and every use case is different, varying degrees of governance are required. The data and content governance models can be right-sized and applied to any kind of data regardless of where it falls in the governance spectrum. Establishing three primary governance models—centralized, delegated, and self-governing—provides the flexibility to satisfy the governance needs of most organizations. Like other Tableau platform management activities, an agile, iterative approach is needed to adapt to new business

requirements as user adoption and engagement increase across your organization. For more information, see [Tableau Governance Models on page 114](#).

A Repeatable Process for Tableau Blueprint

Tableau Blueprint is a step-by-step guide to becoming a data-driven organization. It provides concrete plans, recommendations, and guidelines across critical foundational work and three primary workstreams that will turn repeatable processes into core capabilities. These topics will guide you through key decision points with a proven, repeatable, four-step process:

1. **Discover** — Gather information and perspectives from sponsors and multiple stakeholders about your enterprise architecture, the use of data and analytics among business teams, and analytical skills both present and needed.
2. **Govern** — Define controls, roles, and repeatable processes to make the appropriate data and content available to the corresponding audience.
3. **Deploy** — Establish the iterative, repeatable processes across the three major workstreams to install and configure software, educate users, and enable communications.
4. **Evolve** — Monitor platform utilization, measure user engagement, and host engagement activities to promote and support the growing use of data and analytics.

For existing deployments, use this blueprint to assess your current capabilities—including where you are excelling and where there are areas for growth and improvement.

Step 1: Discover

Tableau Blueprint includes the [Tableau Blueprint Planner](#), a comprehensive planning asset that will help you systematically gather the right information needed to link data with your strategic initiatives, define your analytics strategy, discover analytics and predictions use cases, and assemble the [Executive Sponsor Roles and Responsibilities on page 69](#) and [Tableau Project Team Roles and Responsibilities on page 72](#). This will ensure you are evaluating the needs of the organization holistically, so you can scope a vision and strategy that will suit your entire organization and grow with you over time. After completing discovery, you should have a greater sense of the direction you are headed with your analytics strategy and the roles needed to execute on it. Discovery should be revisited as you expand to new users and use cases, but having a clear view of the future state will help you make decisions as you move forward.

Step 2: Govern

As mentioned above, a clear approach to governance is a pivotal point in the process and must be addressed early. Governance is pervasive throughout every workflow. The time invested up front to collaboratively define governance gives people confidence to trust the data, use it responsibly, and participate in the processes that surround it. [Tableau Governance on page 79](#) covers all aspects of governance in Tableau and helps you determine the best approach for your teams, data, and content. Working through the areas within data and content governance, you will define standards, policies, and roles who perform the corresponding actions and processes in the governance models.

Step 3: Deploy

To scale analytics across the organization with confidence, you need repeatable, iterative processes in the deploy stage as you execute on your analytics strategy. During the initial deployment, there needs to be coordination among the cross-functional team members to install, integrate, and configure the Tableau platform, educate users, and provide organization-specific enablement resources. After the initial deployment, you will onboard new teams and use cases with education and communication.

Step 4: Evolve

Your analytics strategy needs to keep pace with the growth of users, skillsets, and use cases across the organization. As processes evolve into capabilities, your users will adopt modern analytics, and you will adapt your operating models by delegating more responsibilities over time. The project team has access to several sources of information and data to tailor and tune your analytics environment to changing business needs. The project team will be responsive to the growing use of data and analytics among a diverse set of users by establishing a feedback loop to monitor and measure key metrics, including the business value achieved.

Analytics Strategy

To ensure success with your analytics investment, your organization needs a clearly defined vision for deployment. Inputs from people across the organization are crucial to understand the short and long-term goals to promote data-driven decision-making. Your strategy must cover people, process, and change management—including identifying immediate business use cases, defining roles and responsibilities, and establishing a cadence to evaluate success measurements and impact.

Valuable inputs from across the organization will help to guide your analytics deployment and future state—including the roles, responsibilities, architecture, and processes, as well as the success measurements to understand progress. After completing the [Tableau Blueprint Planner](#), you should have a greater sense of the direction you are headed with your analytics strategy by defining your vision for the use of data, identifying strategic initiatives and KPIs, setting Tableau business goals, and documenting risks and challenges.

Discovery Process

The discovery process outlines a systematic approach to gathering information and perspectives from sponsors and multiple stakeholders about roles and responsibilities, enterprise architecture, and the use of data and analytics among business teams. Within each section, the team or role responsible for completing is noted. Discovery is critical for gathering information from sponsors and stakeholders to inform the organization's analytics vision.

The [Tableau Blueprint Planner](#) contains questions you need to answer before deploying Tableau broadly. Your answers will inform activities at every stage and every workstream in the Tableau Blueprint. The following areas are covered within the planner:

- Analytics Strategy (Analytics Vision and Business Value)
- Roles and Responsibilities
- Enterprise Architecture Survey for Tableau Server or Tableau Cloud
- Data and Analytics Survey
- Use Cases and Data Sources
- Data and Content Governance
- Education Role Mapping
- Users

- Community
- Upgrade Planning and Checklist

The [Tableau Data and Analytics Survey](#) on page 42, [Tableau Use Cases and Data Sources](#) on page 45, and [Tableau Users](#) on page 56 sections of the planner should be revisited as you expand to identify new data use cases and users from new departments and teams.

Analytics Vision

It's no secret we're big fans of dashboards and vizzes (i.e., visualizations) here. But let's get real, most customers invest in our platform to achieve business results, not just to create beautiful interactive charts. Bridging the gap between your analytics investment and business outcomes is easier said than done. To help you tackle this, **we recommend setting an analytics vision**. The Analytics Vision tab in the [Tableau Blueprint Planner](#) outlines questions you may want to take into account as you set your analytics vision.

Articulating an analytics vision is key to the success of your analytics investment and foundational to a solid analytics strategy. Whether you decide to define an analytics vision at an organization-wide level, a team level, or both, you'll want to involve key executives early and ensure that high-level organizational goals sit at the heart of your analytics vision. This vision isn't just about technology. This visioning process is about how your organization can better meet its business goals and then align that vision with the right analytics capabilities to do the job.

When drafting your analytics vision, consider your organization's **business goals**, **key performance indicators (KPIs)**, and **strategic initiatives**. In addition to executive-level involvement, generally speaking, we see two types of personas instrumental in delivering on the analytics strategy, business users and data professionals. Business users, those who use data **for** their work, must understand the dependencies and work in partnership with the data professional whose work **is** data. Similarly, the data professional must understand the needs of executives and the business user in terms of **what** they need to know and **how** they want to consume data-driven insights in their workflow. Although their roles and responsibilities will be different under the analytics strategy, all three must work together to determine the best method for enabling data-driven decision-making across the organization.

Below, we outline questions that will help you create an analytics vision. Feel free to keep your answers and ideas at a high level during this exercise, as you'll get into specifics in later steps.

Think about the following questions as you draft your *analytics vision statement*.

Question	Answer
What are our key strategic business goals?	
What are the business outcomes we're striving for with these initiatives?	
What metrics and KPIs can help us track our progress on these business outcomes?	
Who needs access to these metrics and KPIs to make decisions that influence our business outcomes?	
When do these decision-makers need to see this data to make timely decisions?	

Next, think about your current state versus your desired future state.

Question	Current State	Future State
Are business outcomes informed by data and analytics? If so, how?		
How do business users and decision-makers access data?		
What information do they have access to?		
When do they get this information?		
How do they act on this information?		

Use these answers to draft a clear analytics vision statement, outlining at a minimum what impact the use of data and analytics will have, who it will help, and how it will do so.

We also recommend identifying the guiding principles that establish a framework for expected behavior and decision-making to help your organization build a data culture, prioritize analytics capabilities, and realize your analytics vision. One principle we recommend is “we are iterative.” As mentioned earlier, tying the use of data and analytics with your business goals takes time and

effort. It's worth calling out that the process will always need refinement, and you may not be able to affect change in the entire organization in one go. Being explicit about this will help set reasonable expectations so your stakeholders can better stay the course and keep a beginner's mindset.

Example analytics vision: HR will serve accurate data to our business users within their workflows and preferred tools, enabling them to make timely and informed decisions to support our workforce.

Case Study: Setting a Vision for the Superstore HR Data and Analytics Team

In this and the next section (Business Value), we'll use a company's Human Resources (HR) Department as an illustrative example. We'll call our fictional company Superstore.

Superstore HR aims to be more strategic about its use of data and analytics and has decided to leverage the Tableau Blueprint to help its efforts. After reading the Analytics Vision section, the head of HR's Data and Analytics Team convenes a tiger team consisting of herself, several functional leaders, and DEI leaders for a brainstorming session to draft an analytics vision statement. Like many other companies, employee attrition has increased recently and is top of mind for the team. During this exercise, the group decides to focus on one strategic business goal—to improve employee retention. They work through the sample questions together and come up with the following answers:

Question	Answer
What are our key strategic business goals?	Improve employee retention.
What are the business outcomes we're striving for with these initiatives?	<ul style="list-style-type: none"> • Reduce employee attrition by 25%. • Provide understandable and relevant insights, so 100% of functional leaders take action.
What metrics and KPIs can help us track our progress on these business outcomes?	<ul style="list-style-type: none"> • Employee retention rate • Employee satisfaction survey results • Individual Development Plan (IDP) completions • Check-ins between managers and individual contributors (ICs)
Who needs access to these metrics and KPIs	Executives, operations, managers, and indi-

<p>to make decisions that influence our business outcomes?</p>	<p>vidual contributors</p>
<p>When do these decision-makers need to see this data to make timely decisions?</p>	<ul style="list-style-type: none"> • Check-ins between managers and ICs: quarterly • Employee retention rate: monthly • Employee satisfaction survey results: quarterly • IDP completions: <ul style="list-style-type: none"> - Executives need to see completion rates 1 week after each round of due dates - Operations staff need to see completion rates weekly starting from opening of IDPs - Managers need to see completion rates daily

Question	Current State	Future State
<p>Are business outcomes informed by data and analytics? If so, how?</p>	<p>We assume so but can't draw a straight line between data, action, and outcomes.</p>	<p>Yes. We can tell the story of which business outcomes we achieved, which actions were taken, who took those actions, and what data points they used.</p>

How do business users and decision-makers access data?	The HR Data and Analytics Teams push out reports via email. Business users and decision-makers have access to various dashboards published to Tableau Server.	We deliver the data they need within the tools they regularly use. They can access the data on demand through Slack and Tableau Server.
What information do they have access to?	The information that HR includes on reports and publishes to Tableau Server.	We'll deliver the information needed to analyze progress toward business goals and making specific decisions.
When do they get this information?	On a cadence that the HR Data and Analytics Team decides, or whenever they log into Tableau Server and view the dashboards.	We'll embed this information directly in their workflows. They can also request ad hoc data, see it instantly, and set up subscriptions to suit their personal preferences.
How do they act on this information?	We don't know. There aren't defined workflows for each role.	We've embedded the data in

		the tools they normally use, and the call to action is clear. They can click on a button or link to complete the appropriate next steps.
--	--	--

After considering their answers, the group recognizes they currently consider data and analytics “analyst territory,” and decision-makers have limited options for accessing and acting on data. They realize that decision-makers could more easily act on data and insights if the HR Data and Analytics Team is more intentional about what data they provide to these business users and how, when, and where they provide it. They draft the following analytics vision:

EXAMPLE **Analytics Vision**



HR will serve accurate data to our business users within their workflows and preferred tools, enabling them to make timely and informed decisions to support our workforce.

Business Value

By now, you’ve defined your **analytics vision** and are ready for the next step. But what do you focus on next?

Let’s go back to your organization’s original intention—Invest in analytics to drive business outcomes and generate **business value** or return on investment (ROI). Your team has invested time, resources, and money into analytics, and you’ll want to ensure you’re receiving the intended benefit from your investment.

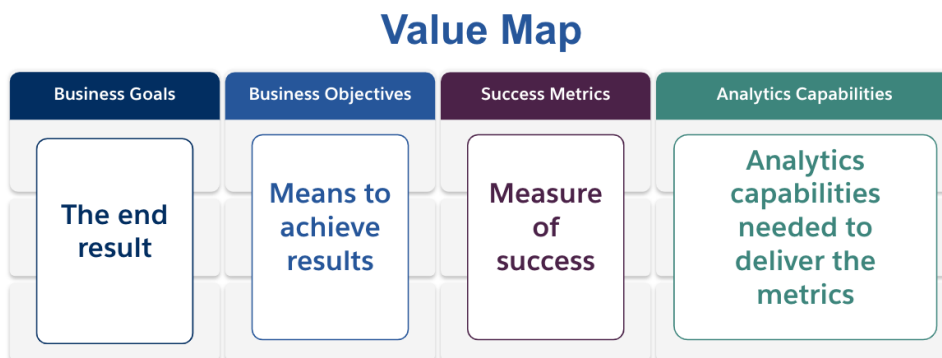
Value, however, isn’t always top of mind as organizations prioritize and deploy analytics. The impact of not leading with value can be significant, ranging from wasted time and resources to a loss of confidence in analytics overall.

So how do you raise visibility on business value as a priority when deploying a product within the Salesforce analytics portfolio? Simple, by creating a **value map**. The Analytics Value Map tab in the [Tableau Blueprint Planner](#) provides a space for you to draft a value map.

What's a value map? It's a consolidated view detailing how your organization measures the success of the products you deploy. It shows you exactly how you'll reach your business goals and how you'll measure success. Value maps are co-created with your stakeholders to ensure alignment between your collective priorities. It's a living document and will evolve over time.

Elements in the value map include **business goals**, **business objectives**, **success metrics**, and **analytics capabilities**. When creating a value map, it's important to recognize that this is a continuous improvement cycle and the order in which you create and think about the map is important.

1. **Determine your business goals**—goals inform objectives.
2. **Define your objectives**—objectives inform metrics.
3. **Identify your success metrics**—metrics help measure progress and keep you on track.
4. **Develop your analytics capabilities**—capabilities enable delivery of your metrics.



Let's dive deeper into each element of the value map.

Business goals—the end result your organization expects to achieve, fixed to business impact. Some questions to consider when defining your business goals include:

- Does it state the business benefit and map to an outcome like revenue, cost, or user experience?
- Does it indicate the strategy for achieving the benefit like from a certain market, product, technology, customer, or channel?

Examples: “Drive \$4.5 billion online revenue by the end of the fiscal year” or “Reduce costs by consolidated technology systems.”

Business objectives—the specific methods your organization will employ to achieve your goals. They further detail the strategy specified in your business goal. Some questions to think about are:

- Does the objective describe how to achieve the goal?
- Is it clear what will change, typically in terms of people, process, and/or technology?
- Can your objective be measured? Is it actionable?

Examples: “Increase order value by increasing the average units per transaction” or “Grow email audience by 30% through better lead generation.”

Success metrics—quantified indicators that help track progress and ensure your organization moves in the right direction. Use metrics to measure the success of your objectives and goals. Consider the following when establishing your success metrics:

- Does the metric measure progress on the objective?
- Can it be measured with reasonable effort over time?
- Does it measure business or process performance, not completions and other vanity data points (e.g., number of dashboard views)?

Examples: “Email click-through rate” or “First-contact resolution rate.”

Analytics capabilities—analytics functionality and technology required to enable delivery of your success metrics. In other words, think of the metrics tied to each business objective. Think about the types of data, analysis, and consumption layers needed to deliver on those metrics. As your organization is mapping this part of the story, you’ll want to prioritize and focus on only your most important capabilities. Questions to consider here:

- Who will interact with the analytics content created?
- How do these audiences want to consume the analytics content?
- Do you have the resources and technical capabilities to serve analytics and insights in the places and platforms your audiences want to consume them?
- Where does your data required for that particular capability live?
- Who is responsible for creating analytics content?

Examples: “Data-driven alerts” or “Ability to merge data from multiple sources.”

Business Value Example: Superstore HR Data and Analytics Team

Our Superstore HR Data and Analytics Team has defined its analytics vision and is ready to draft a value map for its Tableau investment. While they have many business goals, they decide to focus on their initiative to “improve employee retention.” The team reconvenes the original tiger team to draft their business value map.

EXAMPLE **Value Map**

Business Goals	Business Objectives	Analytics Capabilities	Success Metrics
Improve employee retention by providing proactive and accessible insights.	Reduce employee turnover by 25%	<ul style="list-style-type: none"> - Merge data from disparate sources - Allow dashboard users to cut data by different fields - Integrate with everyday tools and applications (e.g., Slack) - Provide timely data-driven risk alerts 	<ul style="list-style-type: none"> - % overall attrition - % voluntary attrition - % involuntary attrition - # IDPs completed, cut by different fields - # check-ins manager and IC check-ins
	Offer competitive compensation at the 75th percentile or above	<ul style="list-style-type: none"> - Merge data from disparate sources - Allow dashboard users to cut data by different fields 	<ul style="list-style-type: none"> - 100% of net-new compensation packages offered at the 75th percentile or above

Tableau Roles and Responsibilities

The Roles & Responsibilities tab, found in the [Tableau Blueprint Planner](#), helps to identify the cross-functional sponsor and project team members. The individuals you select will be responsible for understanding current/future state capabilities, goals, and challenges. Depending on the size and scope of your deployment, the number of people may vary. For more information on roles and responsibilities, see the [Executive Advocacy and Project Team on page 69](#).

Tableau Enterprise Architecture Survey

The Enterprise Architecture Survey assists IT with identifying what platforms and applications will be connected to Tableau. Likely during the product evaluation period, some of the questions about how Tableau fits with your existing technology investments were already considered, but prior to enterprise-wide deployment, it will be beneficial to take a closer look at who owns each system and coordinate the resources needed to fully integrate Tableau within your enterprise architecture. Even if you have an existing deployment, the survey can be helpful in identifying

gaps or what you might integrate next. For more information, see [Tableau Deployment on page 117](#).

Collect the following information about your enterprise architecture for the matching deployment type, Tableau Server, Tableau Cloud, or CRM Analytics:

Tableau Server

Hardware

- Where will you deploy - on-premises, public cloud, or hosted?
- What are your enterprise standard build/specs? (cores, VM, RAM)
- What is your enterprise server operating system?

Availability

- Is Tableau Server mission-critical, requiring high availability?
- What is the recovery time objective (RTO)?
- What is the recovery point objective (RPO)?

Security

- What is your enterprise authentication protocol? (Active Directory, LDAP, SAML)
- What is your security policy for service accounts related to Tableau Server?

Network

- Is SSL required?
- What is your policy on gateway ports over http/https?
- Are there any port restrictions?
- Is internet access from servers permitted?
- Will users access the server externally?

Operations

- What are your enterprise software management tools? (server, client, mobile)
- What are your enterprise monitoring tools? (SCOM, Splunk, etc.)

- How many environments do you require for servers? (dev, UAT, prod)
- What processes exist for backup/restore?

Licensing

- What is the license type (role-based subscription, core, embedded)?
- Will you distribute client software keys or utilize Login-Based License Management to manage license keys?
- How are license assets allocated?
- How will additional licensing purchase be made?
- Is there a chargeback model?

Client Software

- How is client software deployed - Desktop, Prep Builder?
- How is client software upgraded - Desktop, Prep Builder?

Mobile

- Who is the audience for mobile analytics, and what are the primary user scenarios?
- Where will people be when they need data? (In office, the field, a home office)
- How will users reach the Tableau Server if they aren't on the same network?
- Will users need to access data offline, without connecting to the internet or your network?
- Will people use company-owned devices, personal devices (BYOD), or both?
- What mobile device types (phone, tablet) do you support?
- What mobile OS's do you support?
- How sensitive is the data?

Analytics Services

- Will you be integrating external services (R Server, Python, MATLAB, WMS)?

Automation & Extensibility

- What are the requirements for automation, customization? (APIs needed)

Data

- What database technologies (on-premises and cloud) are sources of data?
- What file-based sources of data will be used? (network folder access)
- What security policies exist for database service accounts, user accounts?
- What are your classifications for data security? (secret, confidential, internal, public, etc.)
- Do you have any data that is restricted to a geographic region?
- Are there external and/or government regulations to comply with?
- Are there row-level security requirements?

Tableau Cloud

Security

- What is your preferred authentication protocol? (SAML, Google, TableauID)
- Do you leverage a cloud SSO provider (Azure AD, AD FS, OneLogin, PingOne, Okta, Salesforce)?
- How do you perform user and group provisioning? (Cloud SSO, REST API, Manual)
- What is your security policy for service accounts? (data sources, Tableau Bridge)

Network

- Is SSL required for data source connections? (Tableau Cloud uses SSL by default)
- What is your policy on gateway ports over http/https?
- Are there any port restrictions?
- Is Internet access from internal servers permitted?

Licensing

- Will you distribute client software keys or utilize Login Based License Management to manage license keys?
- How are license assets allocated?
- How will additional licensing purchases be made?
- Is there a charge-back model?

Client Software

- How is client software deployed - Desktop, Prep Builder? (manual, silent, self-service)
- How will client software be updated? (manual, silent, self-service)
- How will Tableau Bridge be deployed and managed? (If needed, centralized recommended)

Cloud Application Integration

- What are the requirements for branding and customization?
- What are the requirements for automation with APIs?
- What are your site monitoring needs? (trust.tableau.com, site status admin views, custom reporting in Admin Insights)

Mobile

- What is your Mobile Device Management solution?
- Who is the audience for mobile analytics, and what are the primary user scenarios?
- Where will people be when they need data? In the field, a home office, or both?
- Will users need to access data offline, without connecting to the internet or your network?
- Will people use company-owned devices, personal devices (BYOD), or both?
- What mobile device types (phone, tablet) do you support?
- What mobile OS's do you support?

Data

- What cloud sources of data will be accessed?
- What on-prem sources of data will be accessed? (databases, Virtual Private Environments, applications, files)
- Will Tableau Bridge be used to move data into Tableau Cloud?
- What security policies exist for database service accounts, user account?
- Will credentials be embedded? Will the credentials be a service account or a data steward account?
- What data security measures, considerations and/or company policies are required by your organization for your internal data?
- Are there external and/or government regulations to comply with?
- Do you have any data that is required to be stored in a geographic region (sales territories, geographic data housing restrictions, etc.)?
- Are there row-level security requirements?

CRM Analytics

Security

- Have all CRM Analytics users been added to the Salesforce org?
- Are you planning to implement any Salesforce related security features like SSO or two authentication steps?
- How do you perform user and group provisioning? (Cloud SSO, REST API, Manual)
- What is your security policy for creating connectors and/or leveraging ETL tools for on premise data?

Network

- Are there any particular security required for data source connections (Connectors)?
- Do any IP addresses need to be added to the allowed-access list?

Licensing

- How are you going to provision and activate licenses (PSLs)?
- Do you have any CRM Analytics community specific licenses?
- How will additional licensing purchases be made?
- Do you need to plan for additional data-rows future purchases?
- Cloud Application Integration
- What are the requirements for branding and customization?
- What are the requirements for automation with APIs?
- Are you planning to use the Predictions API to score data outside Salesforce?
- What are your data monitoring needs (trust.salesforce.com, Jobs under Data Manager, Notifications & Alerts, custom dashboards)?

Mobile

- What is your Mobile Device Management solution?
- Who is the audience for mobile analytics, and what are the primary user scenarios?
- Where will people be when they need data? In the field, a home office, or both?
- Will users need to access data offline, without connecting to the internet or your network?
- Will people use company-owned devices, personal devices (BYOD), or both?
- What mobile device types (phone, tablet) do you support?

- What mobile OS's do you support?
- What are the requirements for branding and customization?
- What are the requirements for automation with APIs?
- Are you planning to use the Predictions API to score data outside Salesforce?
- What are your data monitoring needs (trust.salesforce.com, Jobs under Data Manager, Notifications & Alerts, custom dashboards)?

Data

- What cloud sources of data will be accessed?
- What on premise data sources will be accessed and how (ETL tools, APIs, etc.)?
- What sync policies will you use (incremental or full refreshes, filters, single or multiple local org connections, or live connectors)?
- What security policies exist for database service accounts and user accounts?
- What are the refresh rates and orchestration requirements?
- Will the credentials for connectors be a service account or a data steward account?
- Do you have any snapshotting requirements (storing historical data) and what are the expected volumes vs. provided number of rows available?
- How will you plan for data volume (number of records in datasets) monitoring and clean up?
- What data security measures, considerations and/or company policies are required by your organization for your internal data?
- Are there external and/or government regulations to comply with?
- Do you have any data that is required to be stored in a geographic region (sales territories, geographic data housing restrictions, etc.)?
- Are there row-level security requirements?

Tableau Data and Analytics Survey

For line-of-business leaders, the Data and Analytics Survey, found in the [Tableau Blueprint Planner](#), identifies key sources of data, how data is distributed and consumed, and what analytical skills exist or need to be developed among their teams. Business teams who will be using Tableau should complete the Data and Analytics Survey or work with an IT team member to facilitate documentation of the information. Consider every source of data—from CSV files, reports distributed via email, and local database files, to the enterprise data warehouse, cloud applications, and external sources. This should be part of the onboarding process as new teams

are added. Each Line-of-Business leader should survey their teams for the following information:

Team

- What is the team's function?
- What is the targeted number of users?
- Within the team is there a data engineering function?
- Within the team is there a data science practice or Business Scientist personas for creating models and deploying predictions ?
- Does your team have data access today for what needs to be analyzed?

Data Selection and Management

- What business problems/questions need to be solved/answered?
- How does your team source data? (Salesforce, data warehouse, file exports, third-party)
- What are the key sources of data for the team?
- How often does the data change?
- What refresh rates are required?

Security

- How is data secured?

Distribution

- How is data distributed?
- How frequently is data distributed?
- What formats are used?
- Who prepares reports for distribution?
- Who are the recipients?
- Are there embedding requirements?

Consumption

- How is data consumed? New or replacement solution/report?
- Do consumers export and perform additional manipulation in context of your team?
- How is data used in context of recipient's job/role?

Skills

- What analytical skills and capabilities exist within the team?
- What analytical skills and capabilities need to be developed?
- Who will be identified and trained as the Tableau Champions within the team?

CRM Analytics Predictions Survey

Before creating stories/models and deploying predictions using Einstein Discovery, each Line-of-Business Sponsor should survey their departments and teams to help them prioritize use cases and prediction needs. Each business team who will be using Einstein Discovery should complete the Predictions Survey or work with team members to facilitate documentation of the information. The purpose of the survey is to identify the business use cases that require optimization (descriptive and prescriptive predictions) and the sources of data that are needed. Additionally, this survey will help you determine if data scientist need to be involved, plan and execute prediction deployments, and assign model monitoring responsibilities.

Team

- What is the team's business function?
- Who are the targeted users?
- Do you need to collaborate with an existing data scientist team?
- Does your team have access to the data that needs to be analyzed?
- Who on the team will need full license access to CRM Analytics (to bring the data in, create stories/models, and deploy predictions)?

Selection and Management

- What business use cases will be used for predictions? Have the use cases been qualified as good or bad fit?
- What and where are the key sources of data for stories/models?
- How does your team source data (Salesforce, databases or warehouses, file exports, third-party, etc.?)
- Do you have or require approval for models from a data scientist team?
- Have you incorporated data modeling methods such as CRISP-DM to qualify the business use cases?
- How does the data look for phase 1 (quick and dirty approach) and can you use csv files to populate the dataset?
- How does the data look for production deployment and are you able to leverage data prep and build the orchestration needed?

Skills

Tableau Blueprint Help

- How is data secured?
- What business scientist skills and capabilities exist within the team?
- Who will be identified and trained as the Einstein Discovery Champion (e.g., business scientist) within the team?
- Do you have the necessary business skills and insights to prioritize use cases?
- Do you have the necessary data engineering skills for any derived fields and feature engineering needs?

Security

- Have you already vetted and approved Salesforce cloud products and data centers with regards to using CRM Analytics?

Monitoring

- How are you going to monitor the accuracy of predictions (e.g., Model Manager, custom dashboard)?
- What is the accepted model accuracy threshold and who is going to be notified and alerted if the value is out of bounds?
- How often will you need to refresh model data?
- Who will be responsible for measuring business impact, performance, and adoption rates of the model once it is deployed?
- How will the business monitor and measure the impact on processes and results from deployed predictions?

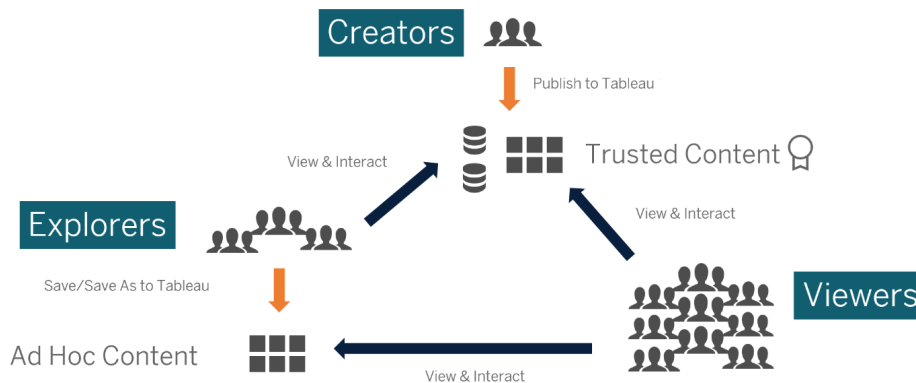
Tableau Use Cases and Data Sources

To identify initial use cases, the project team should complete the Use Cases and Data Sources Worksheet, found in the [Tableau Blueprint Planner](#), after the [Tableau Data and Analytics Survey on page 42](#) has been collected for each department/team to discover and prioritize which sources of data will be most impactful for the participating business teams. When prioritizing sources of data to publish and certify on Tableau Server or Tableau Cloud, begin with low complexity and high impact first to demonstrate quick wins. Publish and certify data sources, create workbooks to answer business questions. As new data sources are identified, they can be added over time. Beyond the initial use cases, this provides a repeatable process to add new data sources as the deployment progresses.

Use Cases

If you are transitioning from a traditional top-down BI approach driven by IT or favor a phased delegation of responsibilities to governed self-service, it is advantageous for IT or a centralized BI team to build the initial use cases across departments, including certified data sources and dashboards.

Over time, as analytical skills increase and users are encouraged to ask and answer their own questions, the domain of available trusted content will grow organically into a wider range of analytic content for self-service.



From Initial Use Cases to Self-Service

Ideas for Initial Use Cases

In addition, Tableau provides [Dashboard Starters](#) for popular line-of-business applications to accelerate content authoring. Content consumers can view and interact with the initial use cases while they ramp-up their analytical skills. After they complete some training, the initial use cases can become the starting point for build new content. Some common initial use cases by department are listed below:

- IT — Hardware/software asset inventory, helpdesk call volume/resolution time, resource allocation, security patch compliance
- Finance — Budget planning and spend, accounts payable, travel expenses
- Marketing — Campaign engagement, web engagement, leads
- Human Resources — Turnover rate, open headcount, new hire retention, employee

satisfaction

- Sales — Sales/quota tracking, pipeline coverage, average deal size, win/loss rate
- Facilities Operations — Physical locations, call center volume/workload distribution, work request volume/resolution time

For more solutions in industries and departments, see [How People Use Tableau](#).

For CRM Analytics, Analytics Apps Templates are available for certain use cases and industries to accelerate your time to value. These apps are immediately configurable and can be used to create datasets from your data and generate pre-templated dashboards and predictions.

- [CRM Analytics Analytics Sales App - Sales Analytics](#). Sales Analytics brings the power of Analytics to Sales Cloud on any device that supports Analytics. With intuitive visualizations based on your Salesforce data, Sales Analytics lets you move from insight to action quickly and helps you turn data into smarter sales.
- [CRM Analytics Services App - Service Analytics](#). The Service Analytics template gets you started fast with Analytics and provides a clear path through your Service Cloud data on any device. Whether you're a service manager or agent, you get everything you need in one place to uncover key data insights to help you grow your business.
- [CRM Analytics for Financial Services](#). CRM Analytics for Financial Services gives financial advisors and personal bankers a comprehensive customer intelligence solution based on the CRM Analytics platform. It includes Einstein Discovery, which lets you create automated artificial intelligence models on any dataset without writing code.
- [Revenue Operations Analytics](#). Use the Revenue Operations Analytics template to help sales teams gain performance insights to build stronger pipelines, improve forecast accuracy, and generate more revenue.
- [B2B Marketing Analytics App](#). B2B Marketing Analytics provides advanced analytics for the data-driven marketer, letting you explore both your marketing and sales data in one place. With powerful dashboards that consolidate Pardot and Sales Cloud data, you can quickly explore data, understand the impact of marketing on revenue, and take instant action to drive marketing results.
- [Analytics for Retail Banking Template](#). Analytics for Retail Banking is part of a suite of CRM Analytics apps for Financial Services Cloud customers. Its dashboards visualize all the metrics and key performance indicators (KPIs) personal bankers require to grow client relationships.
- [Consumer Banking Starter Analytics Template](#). Consumer Banking Starter Analytics is part of a suite of CRM Analytics apps for Financial Services Cloud customers. It gives you

a quick way of creating an analytics solution personal bankers can use to move clients up the value chain.

More Analytics Apps Templates can be found at [Deploy CRM Analytics Prebuilt Apps](#).

Tableau Data and Content Governance

The Data and Content Governance Models worksheet, found in the [Tableau Blueprint Planner](#), walks you through the key considerations for defining centralized, delegated, and self-governing models. This will help you document who is responsible for each area, and what the designated person or team should do. For more information about each area, see [Governance in Tableau on page 81](#) and [Tableau Governance Models on page 114](#).

Data Governance

Data Source Management: includes processes related to selection and distribution of data within your organization.

- What are the key sources of data for a department or team?
- Who is the Data Steward or owner of the data?
- Will you connect live or extract the data?
- Should the data source be embedded or published?
- Do variants of a dataset exist? If so, can they be consolidated as an authoritative source?
- If multiple data sources are consolidated, does the single data source performance or utility suffer by attempting to fulfill too many use cases at once?
- What business questions need to be answered by the data source?
- What naming conventions are used for Published Data Sources?
- Is there a need for multi-org connectors (CRM Analytics only)?
- Will you need to use output connectors (CRM Analytics)?
- Are you considering any ETL tools or API calls to push data from on premise sources (CRM Analytics)?
- Will you need to create multiple local connections to your Salesforce org (CRM Analytics)?

Data Quality: an assessment of data's fitness to serve its purpose in a given context.

Tableau Blueprint Help

- What processes exist for ensuring accuracy, completeness, reliability, and relevance?
- What processes exist to scope upstream/downstream implications of adding or deleting fields from data sources?
- Have you developed a checklist to operationalize the process?
- Who needs to review data prior to it becoming shared and trusted?
- Is your process adaptable to business users and are they able to partner with data owners to report issues?

Enrichment & Preparation: processes used to enhance, refine or prepare raw data for analysis

- Will data enrichment and preparation be centralized or self-service?
- What organizational roles perform data enrichment and preparation?
- What ETL tools and processes should be used to automate enrichment and/or preparation?
- What sources of data provide valuable context when combined with each other?
- How complex are the data sources to be combined?
- Will users be able to use Tableau Prep Builder and/or Tableau Desktop to combine datasets (or Recipes in the case of CRM Analytics)?
- Have standardized join or blend fields been established by the DBA to enable users to enrich and prepare datasets?
- How will you enable self-service data preparation?
- How often should enrichment and preparation processes occur (hourly, daily, monthly) and how will you be notified of failures?
- Which approach are you going to use to combine datasets and/or preserve the dataset's grain level (CRM Analytics)?
- How will you implement feature engineering or hybrid data required for stories/models in predictions (CRM Analytics - Einstein Discovery)?

Data Security: protective measures that are applied to prevent unauthorized access to data

- How do you classify different types of data according to its sensitivity?
- How does someone request access to data?
- Will you use a service account or database security to connect to data?
- What is the appropriate approach to secure data according to sensitivity classification?
- Does your data security meet legal, compliance, and regulatory requirements?
- Are you planning to use Sharing Inheritance from Salesforce or security predicates for data row level security (CRM Analytics)?

- Are you using Salesforce Shield and require reporting against masked fields or encrypted datasets (CRM Analytics)?
- Have you established asset level access for different Salesforce users/groups/roles (CRM Analytics)?
- Are there requirements for using summarized/aggregated datasets to mask detailed level analysis?

Metadata Management: the end-to-end process for creating, controlling, enhancing, attributing, defining and managing a business-friendly semantic layer of data

- What is the process for curating data sources?
- Has the data source been sized to the analysis at hand?
- What is your organizational standard for naming conventions and field formatting?
- Does the Tableau Data Model (Fields or dataset XMDs for CRM Analytics) meet all criteria for curation, including user-friendly naming conventions?
- Has the metadata checklist been defined, published, and integrated into the validation, promotion, and certification processes?
- Have you identified and enabled Actionable fields at each dataset level (CRM Analytics)?

Monitoring & Management: process used to measure successful job execution

- Are schedules available for the times needed for extract refreshes?
- How is raw data ingestion monitored from source systems? Did the jobs complete successfully?
- Are there duplicate sources of data?
- When are extract refreshes scheduled to run? How long do extracts run? Did the refresh succeed or fail?
- Who should receive job execution alerts and notifications?
- Are subscription schedules available after extract refreshes have occurred?
- Are data sources being used? By whom? How does this compare with the expected audience size?
- What is the process to remove stale Published Data Sources?
- What is the process to cleanup unused datasets, including those in private apps (CRM Analytics)?
- Is orchestration (scheduling) needed for syncs, dataflows, and Recipes (CRM Analytics)?
- Who is responsible for monitoring deployed predictions data alerts (CRM Analytics - Einstein Discovery)?

- Who is responsible for refreshing models, including the datasets themselves (CRM Analytics - Einstein Discovery)?

Content Governance

Content Management: processes used to keep workbooks and data sources fresh and relevant

- Will workbooks and data sources be shared across the company?
- Will sites be used to isolate sensitive content or departments?
- Will projects use an organizational (departments/teams), functional (topics), or hybrid approach?
- Have sandbox and production projects been setup to support ad-hoc and validated content?
- Are content naming conventions used?
- Are authors publishing multiple copies of the same workbook with different filters selected?
- Does content have a description, tags, and comply with visual styles?
- Do you have a load time expectation and an exception procedure in place?
- Is there a process to reassign content ownership?
- How are you going to manage apps and publish analytics assets (CRM Analytics)?
- Will you restrict users to save their analytics assets to their private app only (CRM Analytics)?
- Are there any deployed analytics apps from templates or integrated service providers that need to be managed (CRM Analytics)?

Authorization: process of defining permissions model enable access to data and content

- What is the minimum site role for Active Directory/LDAP group synchronization?
- Have you set all permissions for the All Users group in the Default project to None?
- Are any explicit restrictions (Deny permissions) needed on the All Users group to propagate to every user account?
- Have you created groups that correspond to a set of authoring and viewing capabilities for each project?
- Have you reviewed effective permissions on select users to test your permissions model?
- Have you locked permissions at the parent project to maintain security throughout the project hierarchy?
- Have service account usernames/passwords been established for Published Data Sources?

- Are you provisioning users into the Salesforce org that has CRM Analytics enabled (CRM Analytics)?
- How are you managing and assigning permission sets related to CRM Analytics PSLs and permissions (CRM Analytics)?
- Have you planner permissions for apps and mapped them to users/roles/groups from the Salesforce org (CRM Analytics)?
- How are you securing access to connectors with account login information to data sources (CRM Analytics)?
- Have you enabled read access for the Analytics Integration User profile for the required custom fields and objects (CRM Analytics)?

Content Validation: process used to verify that content is correct

- Who is involved in the validation process?
- Is the content accurate, complete, reliable, relevant, and recent?
- Does new content replace existing content?
- Are the underlying data and calculations correct?
- Does the content reflect corporate branding?
- Does the content have a logical layout?
- For data visualizations, are all axes and numbers formatted correctly?
- Do dashboards load within the acceptable performance time?
- Do filters and dashboard actions behave on the targeted views?
- Does the dashboard remain useful in edge case behaviors (filtered to all, none, one value, etc.)?
- Who is tuning models and verifying model metrics (CRM Analytics - Einstein Discovery)?

Content Promotion: process used to bring content from sandbox project to production project

- Who is involved in the promotion process?
- Do content-promoting roles have a checklist of criteria to evaluate?
- Have you clearly delineated between certified content and ad-hoc content by projects?
- Is the process agile to support iterations and innovation?
- Do you have workflows to address both direct and restricted sources of data and workbooks?
- What migration methods will you use for deploying analytics assets from sandbox to production (Tableau CRM)?

- Will you conduct a dark launch for predictions? Will you deploy predictions to specific users in stages (CRM Analytics)?

Content Certification: process used to verify that content has been vetted and can be trusted in operational state

- Who is responsible for designating certified content?
- Have all criteria for achieving certification status been met?
- Are all fields completed: about, certification notes, tags?
- In the case of stories and models, who is certifying the model metrics to be deployed as predictions (CRM Analytics)?

Content Utilization: processes used to measure user engagement

- How much traffic goes to each view?
- What is the definition of stale content? How often is stale content purged?
- How much indirect utilization (alerts & subscriptions) occurs?
- Are subscriptions delivered on time?
- Does the actual audience size match with expectations?
- Does content follow a weekly, monthly, quarterly trend?
- What is the frequency of login or days since last login by user cohort?
- What is the distribution of workbook and data source size?
- Are you planning to use the Adoption Analytics App to monitor utilization (CRM Analytics)?

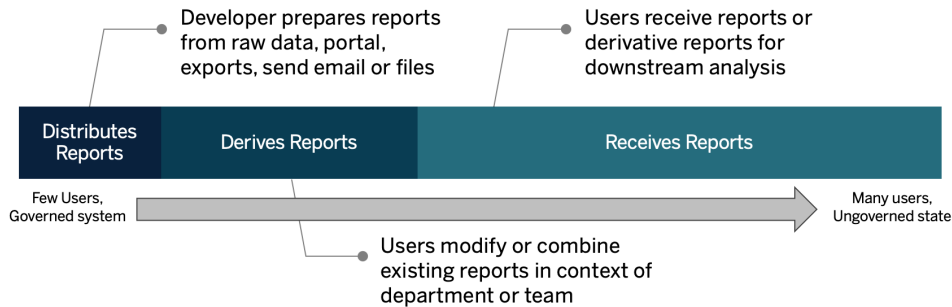
Tableau Education Role Mapping

Your organization is full of people doing different things with data whether they recognize it or not. Some use data to answer questions to drive their lines of business forward. Others prepare spreadsheets and reports that they distribute within their department. Some others pull in raw data from cloud applications or grab quick snapshots of important KPIs to use during team meetings.

Each organizational role or job function has a relationship to data that you should identify and map to Tableau roles. Assessing the skills required to operate Tableau in each organizational role requires an understanding of which tasks can be completed with each product, plus an understanding of how those products correlate to Tableau's licenses that are detailed above. As part of the discovery and planning work you'll do upfront, you'll develop a plan for what licenses you need for your near- and long-term roadmap with Tableau.

Current State Definition

During the discovery process, the Data & Analytics Survey helped you to identify how data is distributed and consumed within a department and existing skills among team members. When you review your survey results, it will be helpful to bucket users into those who distribute, derive, or receive reports.

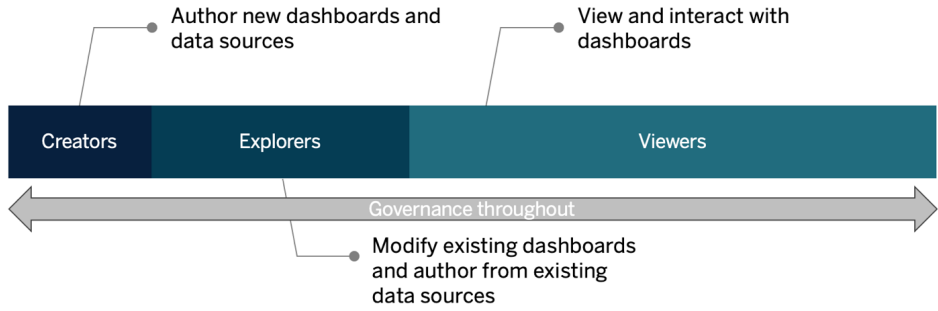


Future State Definition

Once the current state is understood, you should define the future state. Consider how you users will interact with data to determine the license types and education roles needed.

License Types

Using information discovered by the Data & Analytics Survey, you should assess each organizational role's relationship to data, categorize types of users, and determine the best fit for education needs by license type. As the future state diagram shows, those who prepared and distributed reports become Creators, and users who modify and combine existing reports are likely Explorers. Viewers are content consumers. For more information see [Tableau License Types](#) on page 171.



Education Role

We identified twelve Education Roles that map to prescriptive **Learning Paths** that will educate employees in the skills needed to contribute to the growth of a data-driven organization. We recommend that you review the education needs of different organizational roles even if you decide to self-curate education resources or to consume training courses individually. For more information, see [Tableau Education on page 215](#) and related topics.

Enable a data culture in your organization: These roles establish cultural & technical standards to align every Tableau user to the analytics goals of your organization.

	Culture				Data			Role Badge
	Tableau Basics	Blueprint	Data Culture	Governance	Data Analysis	Data Prep	Data Stewardship	
Executive Sponsor	<input type="radio"/>	<input type="radio"/>	<input type="radio"/>					<input checked="" type="checkbox"/>
Community Leader	<input type="radio"/>	<input type="radio"/>	<input type="radio"/>					<input checked="" type="checkbox"/>
Data Steward	<input type="radio"/>			<input type="radio"/>	<input type="radio"/>	<input type="radio"/>	<input type="radio"/>	<input checked="" type="checkbox"/>

Provide insights and develop visualization solutions: These roles use the capabilities of the Tableau platform to consume & create business solutions that range from ad-hoc visualizations to embedded analytics.

	Data Science				Solutions			Role Badge		
	Tableau Basics	Data Analysis	Visual Best Practices	Deep Insights	Data Prep	Statistical Capabilities	Machine Learning		Embedded Analytics	Optimization & Integration
Consumer	<input type="radio"/>								<input checked="" type="checkbox"/>	
Author	<input type="radio"/>	<input type="radio"/>							<input checked="" type="checkbox"/>	
Designer	<input type="radio"/>	<input type="radio"/>	<input type="radio"/>						<input checked="" type="checkbox"/>	
Analyst	<input type="radio"/>	<input type="radio"/>	<input type="radio"/>	<input type="radio"/>					<input checked="" type="checkbox"/>	
Data Scientist	<input type="radio"/>	<input type="radio"/>	<input type="radio"/>	<input type="radio"/>	<input type="radio"/>	<input type="radio"/>	<input type="radio"/>		<input checked="" type="checkbox"/>	
Developer	<input type="radio"/>							<input type="radio"/>	<input type="radio"/>	<input checked="" type="checkbox"/>

Deploy and manage Tableau: These roles plan scalable deployments of Tableau Server or Tableau Cloud and once in production, ensure that users can access what they need when they need it.

	Tableau Basics	Governance	Administration			Deployment		Role Badge
			End User Experience	Security	Monitoring & Auditing	Distributed Environments	High Availability	
Site Admin	<input type="checkbox"/>	<input type="checkbox"/>	<input type="checkbox"/>	<input type="checkbox"/>	<input type="checkbox"/>			<input checked="" type="checkbox"/>
Server Admin	<input type="checkbox"/>	<input type="checkbox"/>	<input type="checkbox"/>	<input type="checkbox"/>	<input type="checkbox"/>			<input checked="" type="checkbox"/>
Server Architect	<input type="checkbox"/>					<input type="checkbox"/>	<input type="checkbox"/>	<input checked="" type="checkbox"/>

Enter the corresponding job titles for each Education Role listed on the Education Role Mapping tab of the [Tableau Blueprint Planner](#). For more information on each Education Role, see [Skills by Tableau Education Role](#) on page 217.

Tableau Users

With the audience size estimated in the Use Cases and Data Sources tab, you will drill-down one more level to list users. The Users tab of the [Tableau Blueprint Planner](#) helps you track individuals' department, license level, learning path, and onboard date. Remember to designate at least one champion per department. Later, you will publish these names in the user directory on your Enablement Intranet, which is outlined in the Communications Guide. Collect the following information for each user or categorize by type of user:

- Name
- Department
- License Level
- Permission Set License (for CRM Analytics)
- Site Role
- Learning Plan
- Onboard Date
- Tableau Champion?

Tableau Community Planning

The Community tab in the [Tableau Blueprint Planner](#) is focused on communications, engagement activities, and support plans to connect people and nurture the use of analytics. Your organization's Tableau user community is just like [Tableau's Community](#), only on a smaller

Tableau Blueprint Help

scale. It's comprised of all the Tableau users in your company. The community leader will coordinate efforts to collect enablement resources and connect users within your company and generate enthusiasm among a group of people founded on the common cause of putting data at the center of every conversation.

Not all items listed on the Community tab are required for launch, and many will evolve over time. The following areas should be assigned to an owner with a due date:

Communications

- Getting Started
- FAQ
- Support
- Announcements
- User Directory
- Governance Models
- Data Platforms
- Certified Data
- Analytics Best Practices
- Visual Style Guide
- Events Calendar
- Learning Plans
- Training Videos
- Company Education Calendar
- User Group Recordings
- Analytics Blog/Newsletter
- Discussion Forums and Chat

Engagement

- Internal User Group
- Internal Admin Group
- Lunch & Learn
- Viz Games
- Tableau Day/Analytics Day

Support

- User Support Process
- Champion Development
- Skills Pyramid
- Mentoring

Tableau Upgrade Planning and Process Checklist

The goal of upgrade planning is to establish a proactive approach to move to the next version of Tableau. With inputs from executive sponsors and the cross-functional project team, this holistic approach goes beyond the technical software upgrade plan by including the communications, education, and support plans needed to successfully execute the upgrade. Complete the Upgrade Planning Checklist tab of the [Tableau Blueprint Planner](#), review the [Upgrades on page 207](#) topic, and customize the Upgrade Process Checklist tab of the [Tableau Blueprint Planner](#) for your requirements.

Early decision points to discuss among the project team are upgrade frequency, version selection, and version compatibility. These will serve as guiding principles for maintaining the environment. By defining the upgrade approach early on, the project team will be able to explain when and how upgrades are performed and better manage users' expectations, rather than reacting to the business demands for new features and functionality.

- **How often will upgrades occur?** Determine the number of Tableau Server upgrades that will occur per year and consider acceptable downtime windows that do not interfere with month-, quarter-, or year-end closing activities and/or blackout periods. For Tableau Cloud, upgrades are performed by Tableau with advance notice, but your administrators will need to update client software to take advantage of new features and functionality.
- **How will the upgrade version be selected?** It is important to fully understand how Tableau is being used to ensure the appropriate version is selected so that it fulfills new business requirements and complies with IT policies. Tableau Cloud is upgraded to latest release by Tableau.
- **How will the new version impact existing solutions?** Evaluate compatibility with existing software versions and custom solutions, such as customized API development for embedded analytics and automation for both Tableau Server and Tableau Cloud.

Software Upgrade Plan

The software upgrade plan is probably what immediately comes to mind when someone thinks about upgrades. It defines the step-by-step procedure to go to the next Tableau software version. The plan should be developed by the IT resources on the project team, using the Upgrade Process Checklist tab of the [Tableau Blueprint Planner](#) as the baseline. The Upgrade Process Checklist should be customized for your requirements, including the upgrade test plans

by selecting top dashboards and data sources to evaluate after the test and production environment upgrades. A rollback plan should also be prepared in case problems are encountered.

For Tableau Server, this work will be performed by the Systems Administrator and Tableau Server Administrator roles, who will upgrade the server environments beginning with the test environment. Once validated in the test environment, they will schedule the production environment upgrade and the disaster recovery environment, if applicable. The Resource Monitoring Tool master server and agents should also be upgraded.

The Desktop Administrator and Mobile Administrator roles will be responsible for packaging and updating Tableau Desktop, Tableau Prep Builder, and Tableau Mobile, which apply to both Tableau Server and Tableau Cloud deployments. Review and upgrade other applications based on your installations, such as tabcmd, Tableau Bridge for Tableau Cloud, and the Content Migration Tool.

Additional input from the Enterprise Architect, Database Administrator, Security Administrator, and Network Administrator roles may be needed if changes are required in the corresponding area of expertise. The following questions should be used for planning:

- What IT roles will be involved in the upgrade?
- Do you have a single production instance of Tableau or multiple production instances of Tableau to be upgraded?
- Do you have a test environment setup that matches the production environment specs and configuration?
- Will your configuration be changing to support high-availability? If it is already HA, are all processes redundant?
- Do you have a disaster recovery environment setup?
- Are backups taken daily and stored outside of the production Tableau Server?
- Are you changing to role-based licensing?
- What are the current and new Tableau Server/Tableau Cloud and Tableau Desktop versions?
- What are the current and new Tableau Prep Builder versions?
- What are the current and new Tableau Mobile versions?
- What are the current and new Resource Monitoring Tool versions?

- What are the current and new tabcmd, Tableau Bridge, or Content Migration Tool versions, if installed on individual computers?
- Are there any programmatic dependencies that will be impacted by the upgrade? (embedded analytics, portal development, automation with APIs)
- Will additional capacity be needed to support new workloads between this upgrade and the next upgrade? (extract refreshes, flow execution, subscriptions)
- Will additional capacity be needed to support the estimated number of new users between this upgrade and the next upgrade?
- Are there any planned platform changes to be completed after the upgrade? (OS, hypervisor, hardware, or cloud provider)
- What is the rollback plan in case there are issues with the upgrade?

Communication Plan

As you design the communications plan, consider your business goals for the upgrade and how users will be notified in advance of the pending upgrade and after its completion on your [Tableau Enablement Intranet on page 277](#). Add the upgrade timeline to your newsletter, and use department Site Administrators or team champions to relay information. In Tableau Server, use a custom sign-in message and site welcome banner for communicating with your users. For more information, see [Customize Your Server](#). Tableau Cloud users will see a message that indicates the maintenance window for the update after sign-in, which you should reinforce with internal communications. The following questions should be used for planning:

- What are the business goals for the upgrade?
- What new features or functionality will be available in the new version?
- How will users be notified of the pending upgrade?
- How will users be notified after the upgrade is completed?
- How will users install new client and mobile software? (silent, self-service, manual)

Education Plan

The education plan will enable your users to understand new features and utilize the new version of Tableau to its full potential. Update your [Tableau Enablement Intranet on page 277](#) content with Tableau-hosted resources, such as What's New topics by product in [Tableau Help](#) documentation, the latest [release notes](#), and launch events.

Augment Tableau-provided resources with training content organization-specific resources that explain how new features will be implemented, including example use cases, and schedule a user group meeting focused on the new functionality. The following questions should be used for planning:

- How are users educated on new features or functionality?
- What Tableau-provided resources will be added to the enablement intranet?
- What company-specific resources need to be created?
- Will Lunch & Learn sessions or on-demand videos be created?

Support Plan

The support plan should define additional resources needed to handle initial demand for post-upgrade support, triage, and the escalation path. Update the [Tableau Enablement Intranet on page 277](#) content. The following questions should be used for planning:

- What self-service help resources are available?
- What incident categories exist for post-upgrade support?
- How are support requests triaged?
- What is the escalation path for post-upgrade incidents?

Tableau Project Planning

Using the [Tableau Blueprint Planner](#), you defined your organization's vision for analytics, identified executive sponsors and project team members, documented the current state of your enterprise architecture, and assessed the usage of data and analytics among each business team.

This is an important step because it provides you with a better understanding of your organization's requirements so that you can plan for the broad use of data and support the growth of analytics. Next, the project team will begin to synthesize the information and document the findings of the discovery process.

Planning Areas

The following questions and summary points for each area of the [Tableau Blueprint Planner](#) are listed below:

- **What is your vision, and what are your strategic initiatives, business goals, and challenges?** (Analytics Strategy tab) Your vision for modern analytics and the broad use of data should be aspirational and actionable, as well as aligned with your organization's goals. Your strategic initiatives and business goals will provide direction for creating KPIs and metrics to track your progress toward desired outcomes. By linking these initiatives to data and analytics, you can use them to motivate your people as a driver of change.

The initiatives will likely showcase executive interest areas and specific content they will use to make business decisions. With executive-level content, your sponsors will be able to exemplify and model data-driven behaviors. Some examples of strategic initiatives might include: improving customer experience, increasing brand awareness, or reducing technical debt with systems modernization. There is data behind each of these examples that can be measured and tracked as progress toward your goal.

By identifying the challenges or obstacles early, you will be more prepared to mitigate those risks to achieving success. Many risks can be offset by a planned and systematic approach to the rollout.

- **Who are the executive sponsors and project team members?** (Roles and Responsibilities tab) The number of people involved in the project is not as important as having someone with the domain knowledge to perform the corresponding role when it is needed. It is important to note that the larger the organization, the more likely it will be to involve more people because of the more specialized roles they contain—make sure you have the right people involved to move the initiative forward.

Executive sponsors should be visible and vocal advocates of the platform. They will work with the project team to consider not only how to scale the technology, but also to ensure adequate support, training, and structure to effectively navigate change management and overcome the roadblocks to becoming a data-driven organization.

The cross-functional project team includes IT/BI Professionals, Tableau Server and/or Site Administrators, and selected Content Authors and Data Stewards from different departments. Set a weekly meeting interval during the initial deployment, and consider moving to bi-weekly or monthly once an operational cadence is achieved. Progress should be reported regularly to the executive sponsors, as well as issues that need to be escalated and resolved by the decision-makers.

If you don't have executive sponsorship yet, then you should focus your efforts on the Data and Analytics Survey and Use Cases and Data Sources tab to identify high impact use cases that prove the value of becoming more data-driven.

- **How will Tableau be integrated with your existing technology investments?** (Enterprise Architecture Survey tabs) This work will be executed in the Agility workstream. Understanding how all these things interoperate is key for installation, configuration, and ongoing operations of Tableau Server or Tableau Cloud.

IT should document the current state enterprise architecture and revisit it periodically as the technology stack changes. Because Tableau is integrated with your platforms, network, databases, and applications, it is important to identify all the integration points.

In addition to systems-level integration points, you should begin packaging and testing the client software, Tableau Desktop and Tableau Prep Builder, for self-service and/or silent installation. If mobile is also in scope, the Tableau Mobile app should be published and tested using the enterprise MDM solution. Also consider who might install other applications, such as tabcmd, the Content Migration Tool, or Tableau Bridge for Tableau Cloud.

- **How is data selected and managed, distributed and consumed, and secured?** (Data and Analytics Survey tab) By surveying each participating business team, the Tableau project team will understand how data is used today, the kind of content that will be most impactful, and how much assistance may be needed. For the current state, consider every source of data—from CSV files, reports distributed via email, and local database files, to the enterprise data warehouse, cloud applications, and external sources.

When distributing the Data and Analytics Survey, check with the stakeholder to see if they feel comfortable answering it on their own or if they would like someone from the project team to interview them. If you have five business teams in scope for your initial deployment, then you should have five total Data and Analytics Surveys to document the information for each team. Once the information is collected from each team, you will find it useful to summarize it and share back with the business team for review.

This survey should be repeated as part of the onboarding process for adding new teams. It also provides a valuable way to connect with teams and better understand how they intend to use Tableau to make data-driven business decisions.

- **What use cases are most impactful?** (Use Cases and Data Sources tab) When prioritizing the sources of data to publish and certify on Tableau Server or Tableau Cloud, begin with low complexity and high impact data to demonstrate quick wins. Impact can usually be measured by audience size or executive interest.

Publish and certify data sources, and create workbooks to answer relevant business questions. Commit to at least one certified data source and one dashboard per team so that they will have content available once they are onboarded.

As new data sources are identified, they can be added over time. Beyond the initial use cases, this provides a repeatable process to add new data sources as the deployment progresses.

- **How will you ensure trust and confidence in data with responsible usage?** (Data and Content Governance tab) From the sources of data discovered in the Data and Analytics Survey and the initial content identified in the Use Cases and Data Sources tab, classify different kinds of data by sensitivity and audience, then define centralized, delegated, and self-governing governance models for each area of data and content governance.

Because governance is a shared responsibility, the models should be defined by the cross-functional project team, as you seek to strike the balance between flexibility and control. Publish your organization's governance models on the enablement intranet for all users to reference. By clearly communicating governance policies, you will reinforce the idea that governance enables, rather than restricts, access to data and build trust in the process.

An iterative approach is needed to adapt to the evolving requirements as user adoption and engagement increase. These conversations should occur early and often.

- **What is a job function's relationship with data?** (Education Role Mapping tab) The project team should use personas that are based on each title's role in the workflow to classify different types of users. We've provided Education Roles that match our training portfolio to serve as a starting point. You can use these roles as-is or customize them to fit your specific requirements by adding ancillary skills needed for specific job functions. For example, anyone with "analyst" in their job title might map to the Analyst education role, and titles of director and above may map to the Executive Sponsor education role. Once

mapped, the corresponding learning paths should be completed by individuals.

For existing employees, coordinate their Tableau onboarding and education with the availability of certified data sources and dashboards. Begin with the content authors and data stewards so they have the initial skillset to begin creating content for others. Publish your training schedules, and record short, introductory, on-demand videos using a team's own data to put analytics in a context they more readily understand.

The earlier you integrate data into your hiring and employee onboarding, the less work you need to do to determine how a particular individual will use data. This is a key step not to be underestimated for building analytics proficiency across the organization, as well as developing and retaining existing talent.

- **Who will be using Tableau, and what licenses are required?** (Tableau Users tab) With the audience size estimated in the Use Cases and Data Sources tab, you will drill-down one more level to list users. The Users tab is where you take an inventory of all users by identifying the department, license level, site role, corresponding education role, and onboarding date.

This work will be executed in the Proficiency workstream with Education, Measurement of User Engagement, and Analytics Best Practices. This step quantifies the number of users by department, team, and education role for training purposes. For Tableau Server, the number of users inventoried will be a significant part of sizing your environment and scheduling user onboarding by planning for future growth.

- **How will you promote sharing and collaboration?** (Community tab) The Community Planning tab outlines the recommended resources and activities for creating a network of users who are excited about data. Focus on the communication plan, the enablement intranet's self-help resources, and the support escalation path for go-live. Plan for your first internal user group meeting and schedule it to occur on a regular interval.

This work will be executed in the Community workstream. It's ok to start out small—both in content and attendance. Don't get discouraged if you don't see high turnout as you're just getting started.

- **How will you stay current on new features and functionality?** (Upgrade Planning and Upgrade Process Checklist tabs) You might be thinking that it's too early to consider how upgrades will be handled, but a proactive approach to how and when upgrades occur will ensure positive outcomes for everyone. The Upgrade Planning and Upgrade Checklist tabs help you establish the guiding principles and supporting software upgrade, communications, education, and support plans to drive successful outcomes as you move to new versions of Tableau Server and client software or client software connecting to Tableau Cloud. This work is executed across the Agility, Proficiency, and Community workstreams.

Project Metrics

"Analytics on your analytics" isn't just a Tableau Conference break-out session title. By analyzing the progress of your deployment, the project team will understand the needs of the organization, from what's working to what's not. It will help you to identify achievements and opportunities for improvement. The following tables provide metrics that will be beneficial to track throughout your deployment:

Executive KPIs

- Percentage of leadership engagement with Tableau content, such as content linked to strategic initiatives;
- Using analytics to run meetings; and measures of department/team performance;
- Expected impact and ROI: increased revenue, reduced costs, and improved business and customer outcomes.

IT KPIs

- Percentage of content authored by business users vs. IT;
- Percentage of data being available vs. analyzed;
- Licenses owned vs. assigned;
- TCO: acquisition, implementation, support, and training costs.

Analytics KPIs:

- Percentage of users onboarded;
- User engagement (organization-level): user login frequency, days since last login, and users who logged in once and didn't return;
- Content created and published (organization-level);
- Content utilization (organization-level);
- Percentage of certified published data sources;
- Ratio of certified project workbooks to ad-hoc project workbooks;
- Percentage of all users trained, such as analytics skill level, role badge, and product certification;
- Percentage of users who increased analytical skills by progressing up education role levels.

Line-of-Business KPIs

- Percentage of users within a team trained;
- Amount of content created and published;
- User behaviors (department- or team-level): user login frequency, days since last login, and users who logged in once and didn't return;
- Worker productivity: increase analyst productivity and knowledge worker efficiency.

Executive Advocacy and Project Team

Becoming a data-driven organization requires more than just choosing the right technology platform. It requires new skillsets, new processes, and changes in behavior from all users within your organization. Enterprise deployment requires effort and coordination across multiple stakeholders and users with different and sometimes opposing viewpoints and interests; however, each one will provide their own valuable perspective. Orchestrating this change, and doing it efficiently, requires buy-in, alignment, and participation from a broad set of cross-functional stakeholders.

Executive sponsors working with the project team need to consider not only how to scale the technology for the entire organization, but also the adequate support, training, change management, and the ability to overcome any organizational roadblocks. Maximizing analytics investments and capitalizing on the transformative potential of data means that everyone encountering it—regardless of skill levels and data fluency—must be able to turn insights into opportunities or innovations.

Forming the cross-functional steering committee and project teams is the first step towards becoming a data-driven organization. The input and skillsets of executives, IT and business stakeholders, and users are critical for buy-in, alignment, and ultimately, the project's success. Together, they will be able to shape your organization's vision for modern analytics most efficiently, working towards the common goal of making secure, governed data access a reality.

The topics in this section outline the key roles for building a culture of analytics and how they are interconnected. The Roles and Responsibilities tab of the [Tableau Blueprint Planner](#) will help you define and document your executive sponsor steering committee and project team members.

Executive Sponsor Roles and Responsibilities

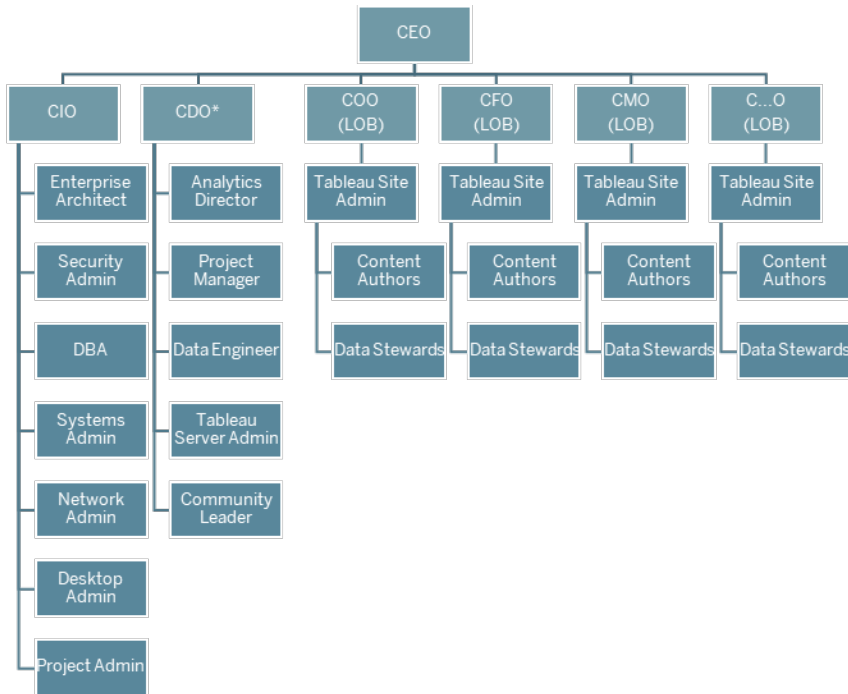
Before you deploy Tableau, you should identify executive sponsors. The executive sponsors set the vision for modern analytics, align projects to transformational initiatives, nominate staff for project and advocacy roles, and ensure accountability. They will serve as the governing body for the use of Tableau. The executive sponsors may also be known as a Tableau Steering Committee, Tableau Council, or Analytics Executive Committee. Whatever name you choose, this cross-functional executive team will:

- Communicate and sell the vision for modern analytics across the organization.
- Represent the interests of their respective departments to establish budget and funding.
- Align the use of analytics with strategic initiatives that drive organizational transformation.
- Approve **Tableau Governance on page 79** processes, policies, guidelines, roles, and responsibilities for managing the organization's data in compliance with business and/or regulatory requirements identified by the project team.
- Set the example of using facts over intuition by placing data at the center of every conversation in their department meetings as a visible and vocal user of the platform.

Given the diversity of use cases that arise within a company-wide initiative, the best way to monitor progress is to evaluate how deeply data is ingrained in the day-to-day activities of the organization and how it impacts business decisions. KPIs may include the following: percentage of leadership engagement with Tableau content, such as content linked to strategic initiatives; using analytics to run meetings; and measures of department/team performance.

Initially, monthly meetings should be held to track the progress of the deployment and influence their teams to adopt Tableau. After an operational routine is achieved, meetings can transition to a quarterly cadence.

Depending on the size and scope of the deployment, the number of executive sponsors and titles (C-level, VP, etc.) may vary. Potential members of the executive steering committee are shown below.



Note: Depending on your organizational structure, the Chief Data & Analytics Officer (CDAO) or Chief Data Office (CDO) role and roles reporting into it may reside under IT.

Executive

**Sponsor
Role**

Responsibilities

IT Sponsor The IT Sponsor (CIO/CTO) is responsible for Tableau installation, configuration, and maintenance, partners with business leaders and SMEs, enables secure, governed data access, and transitions content authoring to business users.

Specific IT KPIs may include the following: percentage of content authored by business users vs. IT, percentage of data being available vs. analyzed.

Analytics Sponsor The Analytics Sponsor (CDO) implements the vision for modern analytics, ensures the availability of data and content, establishes education plans and learning paths by organizational job functions, facilitates communication throughout the user community, and aggregates business value achieved.

**Executive
Sponsor
Role**

Responsibilities

Specific analytics KPIs may include the following: percentage of all users trained, such as analytics skills in organization, percentage of users who increased analytical skills.

**Line-of-
Business
Sponsors**

Line-of-Business Sponsors (CFO, CMO, etc.) advocate for data-driven decision-making within their respective teams, promote content authoring and governed data access, encourage collaboration and sharing, and document business value.

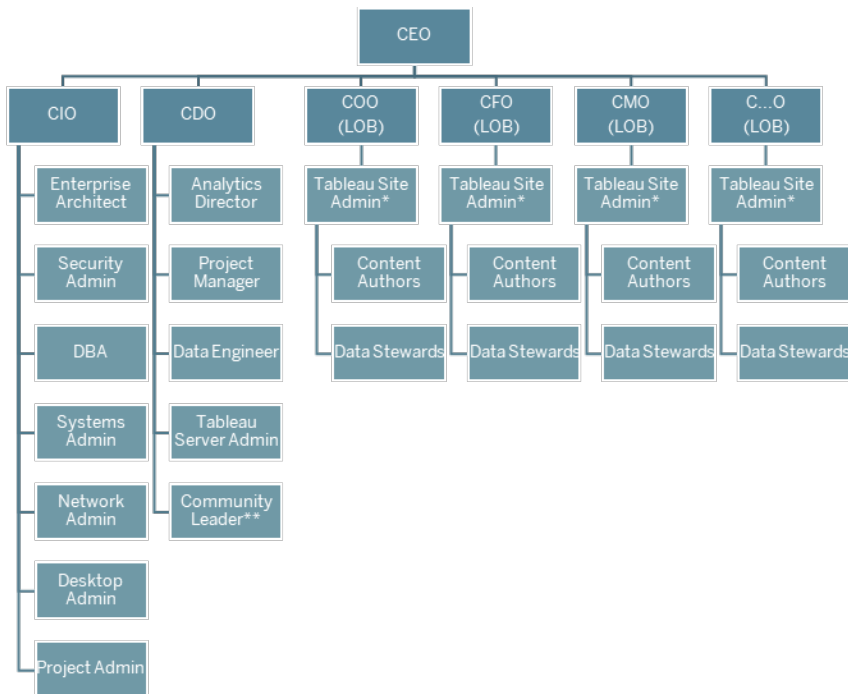
Specific LOB KPIs may include the following: percentage of users within a team trained, amount of content published, user login frequency, days since last login, users who logged in once and didn't return.

Tableau Project Team Roles and Responsibilities

The cross-functional project team includes IT/BI Professionals, Tableau administrators, and selected Content Creators (Data Stewards and Content Creators). The cross-functional project team is focused on the following:

- Establish and maintain the analytics practice, which includes defining **Tableau Governance on page 79** processes, policies, and guidelines.
- Define roles and responsibilities for managing the organization's data in compliance with business and/or regulatory requirements.
- Plan and execute the Tableau deployment and implement the organization's vision for modern analytics.
- Review policies and procedures periodically to adapt to and evolve with changing business needs.

Depending on the size of the organization and the degree of specialization for a particular role, you may find that each of the roles listed below equates to one person in a large organization, while more than one person may serve different roles in smaller organizations. What is most important is that each role is filled at the time it's needed—rather than the number of people on the project team. The diagram below shows where the project team roles may sit in an organizational hierarchy (in larger deployments, community leaders may reside in each of the lines of business).



Note: Tableau Server and Tableau Cloud both support multi-tenancy. Tableau Server Administrators can create sites for segregating users and content and delegating responsibilities for administrative tasks and designate Site Administrators for scoped administration to the site-level. Tableau Cloud Site Administrators manage site settings, create projects for organizing content, and delegate responsibilities for administrative tasks.

IT/BI Professional Roles

The IT/BI professional roles are collectively responsible for integrating Tableau with your enterprise architecture and making data available in a secure, governed manner to Tableau

users. Whether IT and Analytics departments are combined or separate may vary from company to company. Their involvement is critical to planning, installation, configuration, and ongoing management and monitoring of the deployment.

Initially, meetings should be held weekly or every other week to plan and track the progress of the deployment with the full project team. After an operational routine is achieved, meetings can transition to lesser frequency unless you are planning for upgrades, scaling server infrastructure, or integrating with other systems.

IT/BI Professional Role	Responsibilities
Analytics Director or IT Service Owner	The Analytics Director owns the use of Tableau, including placement and fit of analytics within the organization, alignment with strategic initiatives, and user enablement and adoption.
Enterprise Architect	The Enterprise Architect identifies technical requirements and integrates Tableau with enterprise architecture standards.
Security & Compliance Administrator	The Security & Compliance Officer ensures the company complies with its internal security and data security policies and external regulatory requirements.
Database Administrator	The Database Administrator is responsible for the administration, monitoring, maintenance, and security of databases in the organization. Coordinating with data engineers and data stewards, the DBA will provide data access and assist with modeling, structuring, and optimizing sources of data that connect to Tableau.
Systems Administrator	The Systems Administrator installs, configures, manages, and maintains the hardware and operating system on which the Tableau Server or Tableau Bridge is installed in the data center or the cloud, while enforcing company policies in compliance with business and technology strategy.

IT/BI Professional Role	Responsibilities
Network Administrator	The Network Administrator maintains network communications and connectivity, including SSL, VPN, Tableau Bridge, and mobile networking to access Tableau Server or Tableau Cloud.
Client Administrator	The Client Administrator installs and configures client software including database drivers, Tableau Desktop, Tableau Prep Builder, Tableau Mobile, and Tableau Bridge.
Project Manager	The Project Manager ensures that the project is delivered on time and within budget by effectively staffing and managing relationships with a wide range of groups, allocating and utilizing resources in an efficient manner, and maintaining a cooperative, motivated and successful team.
Community Leader	The Community Leader coordinates efforts related to user enablement, including support resources, engagement events, connecting users within your company, and analytics evangelism.
	Note: Not all organizations will have a dedicated position for these responsibilities.

Tableau Administrator Roles

Tableau Server Administrators are responsible for the operation of the server application, while Tableau Site Administrators are responsible for their respective site(s), permissions, content, and users, **when sites are used**.

Initially, weekly or biweekly meetings should be held to track the progress of the deployment, content utilization, and user engagement with the full project team. After an operational routine is achieved, administrator meetings can transition to monthly unless you are planning for upgrades, changing or scaling the infrastructure, or enabling new functionality, such as mobile, advanced analytics, or extensible features.

Administrator Role	Responsibilities
Tableau Server Administrator	<p>The Server Administrator has full access to Tableau Server settings, all sites on the server, users and groups, and all content assets, such as projects, data sources, and workbooks to monitor and maintain overall server health.</p> <p>KPIs for Tableau Server Administrators are outlined in Tableau Monitoring on page 183.</p>
Tableau Site Administrator	<p>In Tableau Server, Tableau Site Administrators create and manage the site's users and groups, create projects to organize content on the site, and assign permissions to allow users (groups) to access the content. They also promote and certify content and measure the use of analytics within their site.</p> <p>In Tableau Cloud, Site Administrators are the highest administrator role. They manage site settings, create projects for organizing content, and delegate responsibilities for administrative tasks. They also promote and certify content and measure the use of analytics within their site.</p> <p>KPIs for Tableau Site Administrators are outlined in Measurement of Tableau User Engagement and Adoption on page 233.</p>

Tableau Content Creator Roles

Content creators include Data Stewards and Content Authors. It is important that the individuals who are selected for the project team have a good understanding of their business domain and data, as well as provide meaningful contributions to the development of organizational policies and procedures. The content creators identified on the project team are known as Tableau Champions. For more information, see [Tableau Support Processes on page 297](#).

During the initial deployment, data stewards and content authors should create certified data sources and relevant workbooks for content consumers to use at launch. Any bottlenecks or issues raised by this group should be shared with the full project team and/or executive governing body for consideration and resolution, depending on the stage of the deployment.

Initially, weekly, or biweekly meetings should be held to track the progress of the deployment, content utilization, and user engagement with the full project team. Weekly meetings for content creators should be held for sharing best practices, planning, and tracking the creation of content, workflow design, and content utilization metrics. After an operational routine is achieved, meetings can transition to a monthly cadence unless you are testing upgrades or enabling new functionality, such as mobile, advanced analytics, or extensible features.

**Content
Creator
Role**

Responsibilities

Data Stewards	Data Stewards understand the business domain and the interaction of business processes with analytics. A Data Steward ensures that there are documented procedures and guidelines for data access and use and will work with the Database Administrator and/or Data Engineers to plan and execute an enterprise-wide data governance and compliance policy. Data Stewards should have a Tableau Creator license.
Content Authors	Content Authors create and publish dashboards and/or data sources. They will also be a resource for others ramping up their Tableau skills. Content Authors should have a Tableau Creator license.

Tableau Content Consumer Roles

Content consumers include everyone who uses Tableau to make data-driven decisions, including licensed Creators, Explorers, and Viewers. While content consumers are not part of the project team, it will be useful to solicit feedback from them periodically to understand their ability to access data, create content, and make data-driven business decisions.

Content consumers will provide valuable feedback throughout your deployment and upgrade cycles. The project team should collect their input during [Tableau Community Engagement on page 287](#) activities and [Tableau Support Processes on page 297](#). If common problems are

surfaced, they should be addressed in the Getting Started and FAQ areas of the [Tableau Enablement Intranet](#) on page 277.

Tableau Governance

Perhaps the most important principle when adopting modern analytics is that self-service and governance are not at odds with each other. Self-service is designed to enable everyone to ask and answer their own questions using trusted data to make informed business decisions.

Governance is central to Tableau Blueprint because it is governance that makes self-service possible. As the anchor point, governance will drive all decisions as the project team develops agility, proficiency, and community across the organization.

Governance is the combination of controls, roles, and repeatable processes that creates trust and confidence in data and analytics. Both IT and business stakeholders on the project team are responsible for defining data and content governance together. In a successful self-service environment, the appropriate levels of governance create accountability and enable, rather than restrict, access to trusted content for users in your organization. Governance is a spectrum—different kinds of data and content require different kinds of governance. It's not a one-time effort because skills and expectations will evolve. Periodically evaluating governance processes will allow you to evolve and delegate more responsibilities as new analytical skills and use cases develop.

In Tableau, you govern two things: data and content. Data governance ensures the accuracy of the data driving your users' decisions. Content governance helps business users to quickly and confidently find, share, and use relevant workbooks and data sources. From soft guidelines to firm boundaries for the usage of Tableau, organizations need to design their own governance models that comply with their internal policies and procedures, and overall business needs. Your organization's governance models should encompass both data and content management processes and the people who understand and comply with the established controls. Like other Tableau platform management activities, an agile, iterative approach is needed to adapt to new business requirements as user adoption and engagement increase across your organization.

Defining the right balance of flexibility and control means you will realize the benefits of both self-service and governance:

- Providing the right data to the right audience in a secure, governed operational model.
- Building the foundation for every data-driven decision.
- Establishing trust and confidence to drive business value.
- Documenting processes in a transparent, understandable, and easily-referenceable format.
- Contributing to the stability of the platform and reducing the proliferation of duplicate data and content with governed workflows.

This document walks through the Modern Analytics Workflow and the role of governance within it, the areas of governance you need to consider, and finally defining governance models. Use this guide with the Data and Content Governance tab of the [Tableau Blueprint Planner](#), which contains key considerations for each governance area, to assist with establishing your organization's standards, processes, and policies to securely manage data and content.

Modern Analytics Workflow

The Modern Analytics Workflow empowers people to ask and answer their own questions with data, enables people to easily share their insights with their team and the rest of the organization, and ensures that the data supporting their decisions is accurate, trusted, and secure. The workflow is comprised of five key actions: Access & View, Interact, Analyze & Discover, Share, and Promote & Govern.



Modern Analytics Workflow

The actions of the Modern Analytics Workflow are executed by the following roles:

- IT and/or BI Professionals — Tableau Server Administrators install, manage, monitor, and maintain a Tableau deployment. Server Administrators, or by delegation to Site Administrators, perform user provisioning, maintain security and permissions, and provide governance oversight. For Tableau Cloud, IT Professionals will integrate with your existing technology investments, such as authentication and data connectivity, while Tableau Cloud Site Administrators will perform user provisioning, maintain security and permissions, and provide governance oversight. In both Tableau Server and Tableau Cloud, administration can be scoped to the project level using Project Leader permissions.
- Content Creators — Tableau Creators are licensed with Tableau Prep Builder, Tableau Desktop, and full Tableau Server or Tableau Cloud authoring capabilities, including connecting to data, to create content. Tableau Explorers perform all authoring within Web Authoring with existing content. Site Administrators and Tableau Creators or Tableau Explorers with the appropriate permissions can validate, promote, and certify content.
- Information Consumers — Tableau Viewers access, view, and interact with content in Tableau Server or Tableau Cloud, including desktop, tablet, and phone. Server and Site Administrators, Creators, and Explorers can consume content as well.

With increasing analytical skills, the boundaries between these roles become more fluid as someone can switch from consuming to creating to promoting content, assuming the appropriate license and permissions.

Governance in Tableau

Governance in Tableau is a critical step to driving usage and adoption of analytics while maintaining security and integrity of the data. You must define standards, processes, and policies to securely manage data and content through the Modern Analytics Workflow. Just as important as defining these is having everyone in the workflow understand and comply so that users will have trust and confidence in the analytics they'll use to make data-driven decisions.

To define your organization's [Tableau Governance Models on page 114](#), you should work through the areas of data and content governance that are outlined in the diagram below using the [Tableau Blueprint Planner](#).



Data Governance in Tableau

The purpose of data governance in the [Modern Analytics Workflow on page 80](#) is to ensure that the right data is available to the right people in the organization, at the time they need it. It creates accountability and enables, rather than restricts, access to secure and trusted content and for users of all skill levels.

Data Source Management

Data source management includes processes related to selection and distribution of data within your organization. Tableau connects to your enterprise data platforms and leverages the governance you already have applied to those systems. In a self-service environment, content authors and data stewards have the ability to connect to various data sources, build and publish

data sources, workbooks, and other content. Without these processes, there will be a proliferation of duplicate data sources, which will cause confusion among users, increase likelihood of errors, and consume system resources.

Tableau's hybrid data architecture provides two modes for interacting with data, using a live query or an in-memory extract. Switching between the two is as easy as selecting the right option for your use case. In both live and extract use cases, users may connect to your existing data warehouse tables, views, and stored procedures to leverage those with no additional work.

Live queries are appropriate if you have invested in a fast database, need up-to-the-minute data, or use [Initial SQL](#). In-memory extracts should be used if your database or network is too slow for interactive queries, to take load off transactional databases, or when offline data access is required.

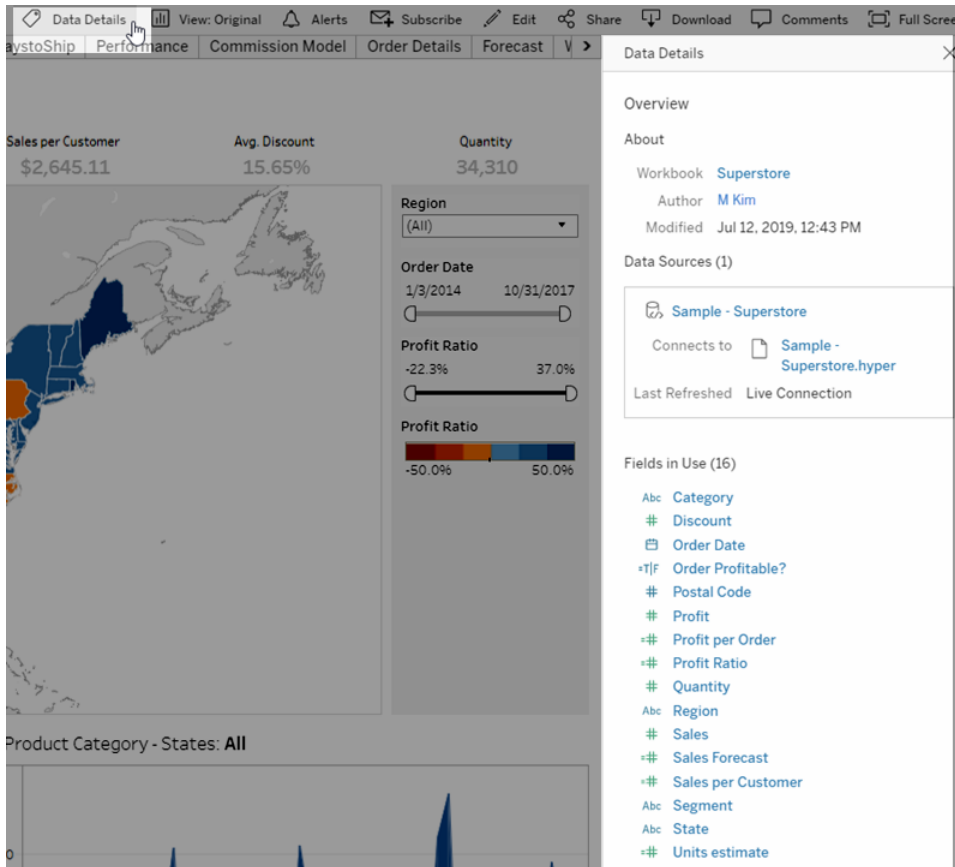
With support for a new multi-table logical layer and relationships in Tableau 2020.2, users aren't limited to using data from a single, flat, denormalized table in a Tableau Data Source. They can now build multi-table data sources with flexible, LOD-aware relationships between tables, without having to specify join types in anticipation of what questions can be asked of the data. With multi-table support, Tableau data sources can now directly represent common enterprise data models such as star and snowflake schemas, as well as more complex, multi-fact models. Multiple levels of detail are supported in a single data source, so fewer data sources are needed to represent the same data. Relationships are more flexible than database joins and can support additional use-cases as they arise, reducing the need to build new data models to answer new questions. Using relationships in well-modeled schemas can reduce both the time to create a data model as well as the number of data sources to answer business questions. For more information, see [Metadata Management](#) on page 91 later in this section and [The Tableau Data Model](#).

When publishing a workbook to Tableau Server or Tableau Cloud, the author will have a choice to publish the data source or leave it embedded in the workbook. The data source management processes you define will govern this decision. With Tableau Data Server, which is a built-in component of the Tableau platform, you can share and reuse data models, secure how your users access data, and manage and consolidate extracts with Published Data Sources. Further, Published Data Sources allow Tableau Creator- and Explorer-licensed users to have access to secure, trusted data in Tableau for web authoring and Ask Data. For more information, see [Best Practices for Published Data Sources](#), [Edit Views on the Web](#), and [Optimize Data for Ask Data](#).

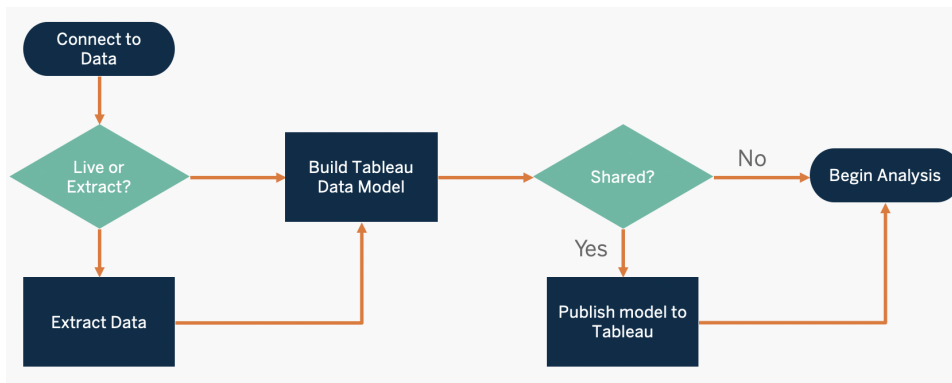
With increased data discovery capabilities, [Tableau Catalog](#) indexes all content, including workbooks, data sources, and flows to allow authors to search for fields, columns, databases, and tables in workbooks and published data sources. For more information, see [Data Management](#).

When Tableau Catalog is enabled, content authors can **Search for Data** by selecting from **Data Sources, Databases and Files, or Tables** to see if it exists in Tableau Server and Tableau Cloud and minimize duplication of data sources.

In addition, the **Data Details** tab on a view published to Tableau Server and Tableau Cloud will provide consumers with relevant information about the data used in it. Details include information about the workbook (name, author, date modified), the data sources used in the view, and a list of the fields in use.



For data stewards who create new Published Data Sources, the workflow below shows the two major decision points that impact data source management—live or extract and embedded or shared data model. This is not to imply that a formal modeling process must always occur before analysis begins.



To discover and prioritize key sources of data, use the [Tableau Data and Analytics Survey](#) on page 42 and [Tableau Use Cases and Data Sources](#) on page 45 tabs in the [Tableau Blueprint Planner](#).

Key Considerations for Data Source Management

- What are the key sources of data for a department or team?
- Who is the data steward or owner of the data?
- Will you connect live or extract the data?
- Should the data source be embedded or published?
- Do variants of a dataset exist? If so, can they be consolidated as an authoritative source?
- If multiple data sources are consolidated, does the single data source performance or utility suffer by attempting to fulfill too many use cases at once?
- What business questions need to be answered by the data source?
- What naming conventions are used for Published Data Sources?

Data Quality

Data quality is a measure of data's fitness to serve its purpose in a given context—in this case, for making business decisions. The quality of data is determined by factors such as accuracy, completeness, reliability, relevance, and freshness. You likely already have processes in place to ensure data quality as it is ingested from source systems, and the more that is fixed in upstream processes, the less correction will be needed at the time of analysis. You should ensure data quality is consistent all the way through to consumption.

As you are planning, it is a good time to review existing upstream data quality checks because data will be available to a larger group of users under a self-service model. In addition, Tableau Prep Builder and Tableau Desktop are great tools for detecting data quality issues. By establishing a process to report data quality issues to the IT team or data steward, the data quality will become an integral part of building trust and confidence in the data.

With [Tableau Data Management](#) and [Tableau Catalog](#), you should communicate data quality issues to your users to increase visibility and trust in the data. When a problem exists, you can set a warning message on a data asset so that users of that data asset are aware of particular issues. For example, you might want to let users know that the data hasn't been refreshed in two weeks or that a data source has been deprecated. You can set one data quality warning per data asset, such as a data source, database, flow, or table. For more information, see [Set a Data Quality Warning](#), including the following types: Warning, Deprecated, Stale Data, and Under Maintenance.

Data Quality Warning

airlines

Enable warning

When enabled, the warning you set is visible to users of this asset and of any asset downstream from it.

Select the warning to display:

Warning type

Stale data ▼

Message (optional)

This data hasn't been refreshed since 7/17/19.

46 / 4,000

Cancel
Save

Note that you can set a data quality warning using REST API. For more information, see [Add Data Quality Warning](#) in the Tableau REST API Help.

Key Considerations for Data Quality

- What processes exist for ensuring accuracy, completeness, reliability, and relevance?
- Have you developed a checklist to operationalize the process?
- Who needs to review data prior to it becoming shared and trusted?
- Is your process adaptable to business users and are they able to partner with data owners to report issues?

Enrichment & Preparation

Enrichment and preparation include the processes used to enhance, refine, or prepare raw data for analysis. Often a single data source does not answer all the questions a user may have. Adding data from different sources adds valuable context. You likely already have ETL processes to clean, combine, aggregate, and store data when ingesting raw data from various sources. With command line interfaces and APIs, Tableau can be integrated with your existing processes.

For [self-service data preparation](#), [Tableau Prep Builder](#) and [Tableau Prep Conductor](#), should be used to combine multiple sources of data and automate on a schedule. Tableau Prep has multiple output types to Tableau Server or Tableau Cloud, including CSV, Hyper, and TDE, or Published Data Sources. Beginning with 2020.3, Tableau Prep outputs include database tables, where the result of a flow can be saved to a table in a relational database. This means that prepped data from Tableau Prep Builder can be stored and governed in a central location and leveraged throughout your organization. Tableau Prep Builder is part of the Tableau Creator license, while Tableau Prep Conductor is part of [Tableau Data Management](#). Tableau Data Management helps you better manage the data within your analytics environment from data preparation to cataloging, search, and governance, ensuring that trusted and up-to-date data is always used to drive decisions.

With visual, smart, direct feedback at every step, Tableau Prep Builder will help users to prototype and prepare disparate sources of data for analysis. Once the steps are defined and verified, the flow should be published to Tableau Server and Tableau Cloud where Prep Conductor will execute the flow and output a Published Data Source on the specified schedule. Automation creates a consistent process, reduces error-prone manual steps, tracks success/failure, and saves time. Users will have confidence in the output because the steps can be viewed on Tableau Server or Tableau Cloud.

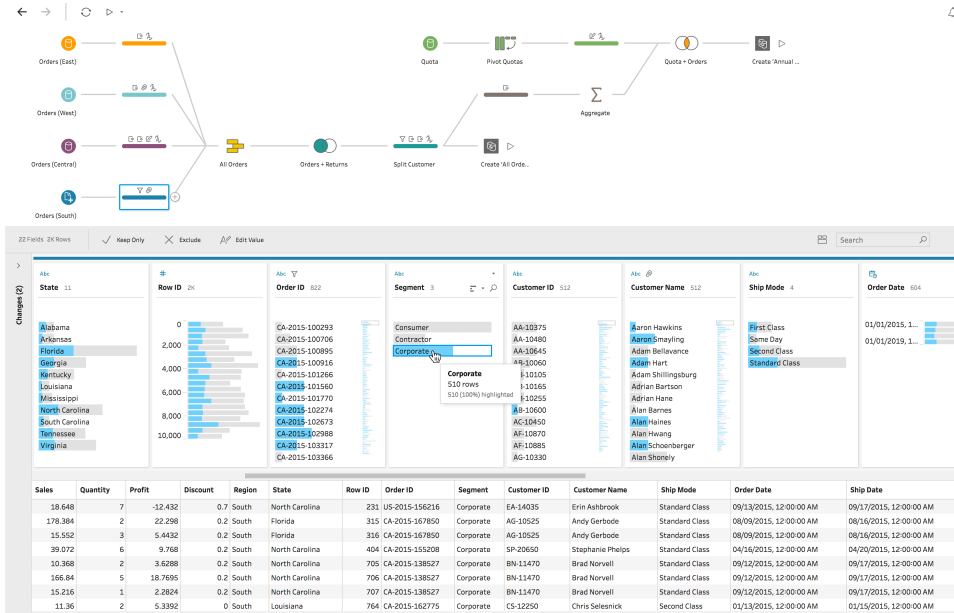


Tableau Prep Flow

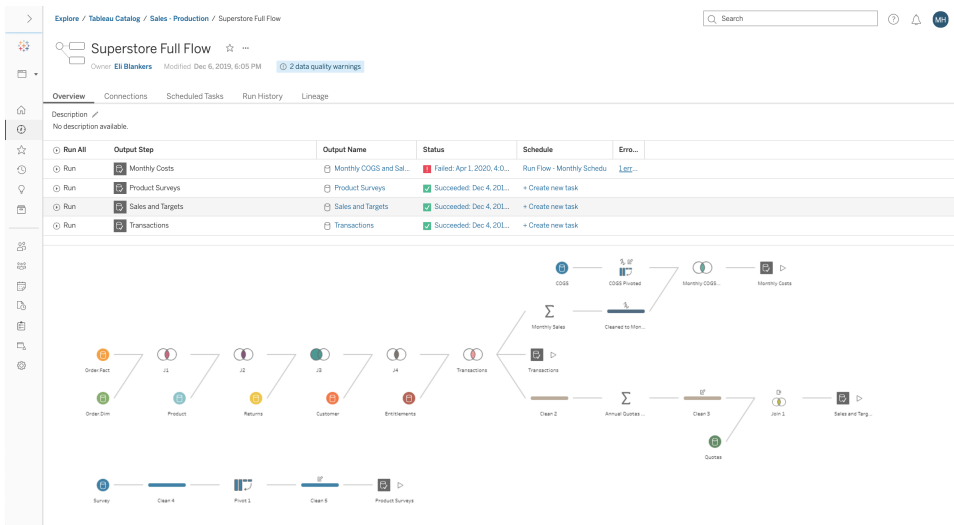


Tableau Prep Flow in Tableau Server or Tableau Cloud

Key Considerations for Data Enrichment

- Will data enrichment and preparation be centralized or self-service?
- What organizational roles perform data enrichment and preparation?
- What ETL tools and processes should be used to automate enrichment and/or preparation?
- What sources of data provide valuable context when combined with each other?
- How complex are the data sources to be combined?

- Will users be able to use Tableau Prep Builder and/or Tableau Desktop to combine datasets?
- Have standardized join or blend fields been established by the DBA to enable users to enrich and prepare datasets?
- How will you enable self-service data preparation?

Data Security

Data security is of utmost importance in every enterprise. Tableau allows customers to build upon their existing data security implementations. IT administrators have the flexibility to implement security within the database with database authentication, within Tableau with permissions, or a hybrid approach of both. Security will be enforced regardless of whether users are accessing the data from published views on the web, on mobile devices, or through Tableau Desktop and Tableau Prep Builder. Customers often favor the hybrid approach for its flexibility to handle different kinds of use cases. Start by establishing a data security classification to define the different types of data and levels of sensitivity that exist in your organization.

When leveraging database security, it is important to note that the method chosen for authentication to the database is key. This level of authentication is separate from the Tableau Server or Tableau Cloud authentication (i.e. when a user logs into Tableau Server or Tableau Cloud, he or she is not yet logging into the database). This means that Tableau Server and Tableau Cloud users will also need to have credentials (their own username/password or service account username/password) to connect to the database for the database-level security to apply. To further protect your data, Tableau only needs read-access credentials to the database, which prevents publishers from accidentally changing the underlying data. Alternatively, in some cases, it is useful to give the database user permission to create temporary tables. This can have both performance and security advantages because the temporary data is stored in the database rather than in Tableau. For Tableau Cloud, you need to embed credentials to use automatic refreshes in the connection information for the data source. For Google and Salesforce.com data sources, you can embed credentials in the form of OAuth 2.0 access tokens.

Extract encryption at rest is a data security feature that allows you to encrypt .hyper extracts while they are stored on Tableau Server. Tableau Server administrators can enforce encryption of all extracts on their site or allow users to specify to encrypt all extracts associated with particular published workbooks or data sources. For more information, see [Extract Encryption at Rest](#).

If your organization is deploying Data Extract Encryption at Rest, then you may optionally configure Tableau Server to use AWS as the KMS for extract encryption. **To enable AWS KMS or Azure KMS, you must deploy Tableau Server in AWS or Azure, respectively, and be**

licensed for [Advanced Management for Tableau Server](#). In the AWS scenario, Tableau Server uses the AWS KMS customer master key (CMK) to generate an [AWS data key](#). Tableau Server uses the AWS data key as the root master key for all encrypted extracts. In the Azure scenario, Tableau Server uses the Azure Key Vault to encrypt the root master key (RMK) for all encrypted extracts. However, even when configured for AWS KMS or Azure KMS integration, the native Java keystore and local KMS are still used for secure storage of secrets on Tableau Server. The AWS KMS or Azure KMS is only used to encrypt the root master key for encrypted extracts. For more information, see [Key Management System](#).

For Tableau Cloud, all data is encrypted at rest by default. Although with [Advanced Management for Tableau Cloud](#), you can take more control over key rotation and auditing by leveraging [Customer-Managed Encryption Keys](#). Customer-Managed Encryption Keys give you an extra level of security by allowing you to encrypt your site's data extracts with a customer managed site-specific key. The Salesforce Key Management System (KMS) instance stores the default site-specific encryption key for anyone who enables encryption on a site. The encryption process follows a key hierarchy. First, Tableau Cloud encrypts an extract. Next, Tableau Cloud KMS checks its key caches for a suitable data key. If a key isn't found, one is generated by the KMS GenerateDataKey API, using the permission granted by the key policy that's associated with the key. AWS KMS uses the CMK to generate a data key and returns a plaintext copy and encrypted copy to Tableau Cloud. Tableau Cloud uses the plaintext copy of the data key to encrypt the data and stores the encrypted copy of the key along with the encrypted data.

You can limit which users see what data by setting user filters on data sources in both Tableau Server and Tableau Cloud. This allows you to better control what data users see in a published view based on their Tableau Server login account. Using this technique, a regional manager is able to view data for her region but not the data for the other regional managers. With these data security approaches, you can publish a single view or dashboard in a way that provides secure, personalized data and analysis to a wide range of users on Tableau Cloud or Tableau Server. For more information, see [Data Security](#) and [Restrict Access at the Data Row Level](#). If row-level security is paramount to your analytics use case, with [Tableau Data Management](#), you can leverage virtual connections with data policies to implement user filtering at scale. For more information, see [Virtual Connections and Data Policies](#).

Key Considerations for Data Security

- How do you classify different types of data according to its sensitivity?
- How does someone request access to data?
- Will you use a service account or database security to connect to data?

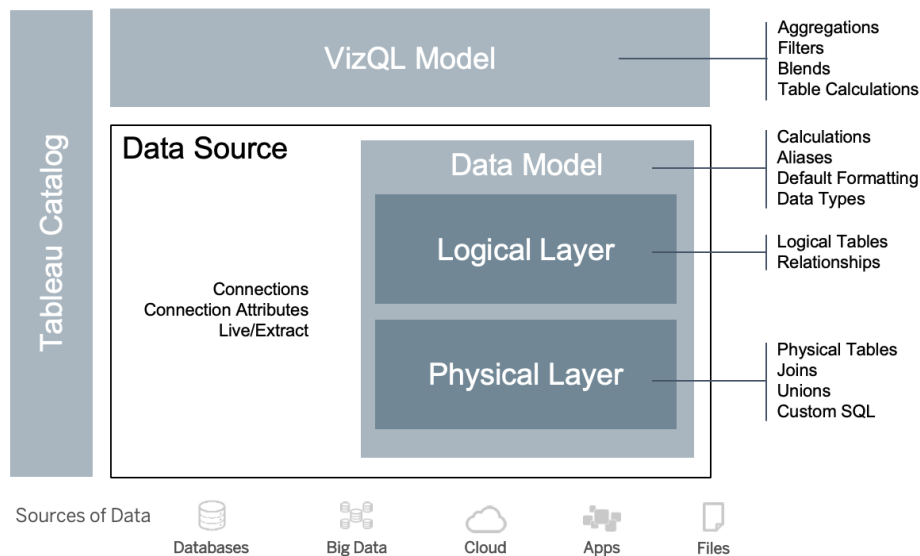
- What is the appropriate approach to secure data according to sensitivity classification?
- Does your data security meet legal, compliance, and regulatory requirements?

Metadata Management

Metadata management includes policies and processes that ensure information can be accessed, shared, analyzed and maintained across the organization, as an extension of Data Source Management. Metadata is a business-friendly representation of data in common terms, similar to a semantic layer in traditional BI platforms. Curated data sources hide the complexity of your organization’s modern data architecture and make fields immediately understandable regardless of the data store and table from which it was sourced.

Tableau employs a simple, elegant, and powerful metadata system that gives users flexibility while allowing for enterprise metadata management. The Tableau Data Model can be embedded in a workbook or centrally managed as a Published Data Source with Data Server. After connecting to data and creating the Tableau Data Model, which will become a Published Data Source on Tableau Server or Tableau Cloud, look at it from your users’ perspective and see how much easier analytics will be when they have a well-formatted starting point, filtered and sized to the business questions it can answer. For more information on Published Data Sources, visit [The Tableau Data Model](#), [Best Practices for Published Data Sources](#) and [Enabling Governed Data Access with Tableau Data Server](#).

The diagram below shows where elements exist in the Tableau Data Model:



Beginning in 2020.2, the Data Source includes the connection, connection attributes, and the physical and logical layers within a Data Model. Upon connection, Tableau automatically characterizes fields as dimensions or measures. In addition, the Data Model stores calculations, aliases, and formatting. The physical layer includes physical tables defined by joins, unions, and/or custom SQL. Each group of one or more physical tables defines a logical table, which resides in the logical layer along with relationships.

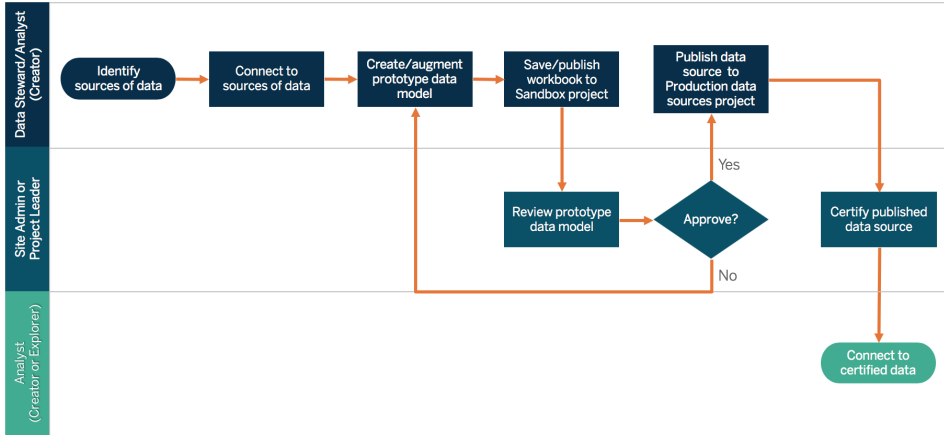
Relationships are a new way to model data that is more flexible than using joins. A relationship describes how two tables relate to each other, based on common fields, but it does not combine the tables together as the result of a join does. Relationships provide several advantages over using joins.

- You don't need to configure join types between tables. You only need to select the fields to define the relationship.
- Relationships use joins, but they are automatic. Relationships postpone the selection of join types to the time and context of analysis.
- Tableau uses relationships to automatically generate correct aggregations and appropriate joins during analysis, based on the current context of the fields in use in a worksheet.
- Multiple tables at different levels of detail are supported in a single data source, so fewer data sources are needed to represent the same data.
- Unmatched measure values are not dropped (no accidental loss of data).
- Tableau will generate queries only for the data that is relevant to the current view.

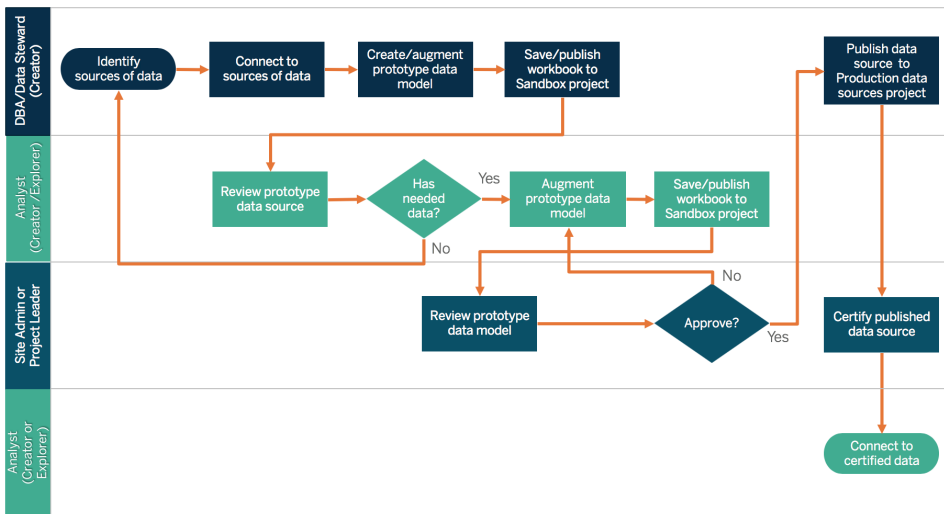
At run-time in the VizQL model, multiple queries are built dynamically based on the dimensions and measures of the visualization and filters, aggregations, and table calculations are applied. Tableau uses the contextual information of the separate logical table to determine what joins are applied to provide the correct aggregation. This enables one user to design the Data Source without needing to know, plan, or otherwise account for all the variations of analysis to be performed with the Data Source by other users. Tableau Catalog discovers and indexes all of the content on Tableau, including workbooks, data sources, sheets, and flows.

Data stewards or authors with direct access to sources of data should prototype data sources as an embedded data source in a Tableau workbook and then create a Published Data Source in Tableau to share the curated Tableau Data Model, as shown below in the direct access workflow:

Tableau Blueprint Help



If authors do not have direct access to sources of data, they will rely on a DBA or data steward to provide the prototype data source embedded in a Tableau workbook. After reviewing and verifying it contains the needed data, a Site Administrator or Project Leader will create a Published Data Source in Tableau to share the Tableau Data Model, as shown below in the restricted access workflow:



The metadata checklist identifies best practices for curating a Published Data Source. By establishing data standards using the checklist, you'll enable the business with governed self-service data access that is user-friendly and easy to understand. Prior to creating an extract or Published Data Source in Tableau, review and apply the following checklist to the Tableau Data Model:

- Validate the data model
- Filter and size to the analysis at hand

- Use standard, user-friendly naming conventions
- Add field name synonyms and custom suggestions for Ask Data
- Create hierarchies (drill paths)
- Set data types
- Apply formatting (dates, numbers)
- Set fiscal year start date, if applicable
- Add new calculations
- Remove duplicate or test calculations
- Enter field descriptions as comments
- Aggregate to highest level
- Hide unused fields

Beginning in 2019.3 in [Data Management](#), [Tableau Catalog](#) discovers and indexes all of the content on Tableau, including workbooks, data sources, sheets, and flows. Indexing is used to gather information about the metadata, schemas, and lineage of the content. Then from the metadata, Tableau Catalog identifies all of the databases, files, and tables used by the content on your Tableau Server or Tableau Cloud site. Knowing where your data comes from is key to trusting the data, and knowing who else uses it means you can analyze the impact of changes data in your environment. The lineage feature in Tableau Catalog indexes both internal and external content. For more information, see [Use Lineage for Impact Analysis](#).

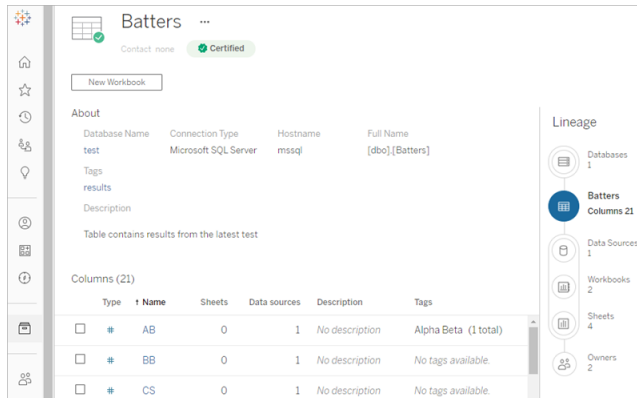
The screenshot displays the Tableau Catalog interface for the 'Orders (superstore)' data source. The 'Lineage' tab is active, showing a hierarchical view of the data source's lineage. The main table lists the following fields:

Type	Name	Sheets	Description	Sensitivity
Text	Ship Mode	0	No description	
Date	Ship Date	3	No description	
Number	Orders (Count)	0	No description	
Text	Order ID	3	No description	
Date	Order Date	3	No description	
Text	Customer ID	0	No description	
Number	Address ID	3	No description	

The lineage diagram on the right shows the following structure:

- Databases: 1
- Tables: 1
- Orders (superstore) Fields: 7
- Workbooks: 3
- Sheets: 3
- Owners: 1

Tableau Blueprint Help



Using lineage, you can trace down to content owners at the end of the lineage graph. The list of owners includes anyone assigned as the owner of a workbook, data source, or flow, and anyone assigned as the contact for a database or table in the lineage. If a change is going to be made, you can email owners to let them know about its impact. For more information, see [Use email to contact owners](#).

Key Considerations for Metadata Management

- What is the process for curating data sources?
- Has the data source been sized to the analysis at hand?
- What is your organizational standard for naming conventions and field formatting?
- Does the Tableau Data Model meet all criteria for curation, including user-friendly naming conventions?
- Has the metadata checklist been defined, published, and integrated into the validation, promotion, and certification processes?

Monitoring & Management

Monitoring is a critical piece of the self-service model as it allows IT and administrators to understand how data is being used and be proactive and responsive about usage, performance, data connectivity, and refresh failures. Depending on your company's database standards, IT will use a combination of tools and job schedulers for ingesting and monitoring raw data and server health.

Just as business users leverage data to make smarter decisions, administrators are also empowered to make data-driven decisions about their Tableau deployment. With Tableau Server's default administrative views and custom administrative views, Tableau Server and Site Administrators will use default administrative views for monitoring the status of extract refreshes, data source utilization, and delivery of subscriptions and alerts. Custom administrative views are

created from Tableau Server's repository data. In Tableau Cloud, Site Administrators have access to [Monitor Site Activity](#) with default administrative views and can [Use Admin Insights to Create Custom Views](#). For more information, see [Tableau Monitoring on page 183](#) and the [Measurement of Tableau User Engagement and Adoption on page 233](#).

Key Considerations for Monitoring & Management

- Are schedules available for the times needed for extract refreshes?
- How is raw data ingestion monitored from source systems? Did the jobs complete successfully?
- Are there duplicate sources of data?
- When are extract refreshes scheduled to run? How long do extracts run on server? Did the refresh succeed or fail?
- Are subscription schedules available after extract refreshes have occurred?
- Are data sources being used? By whom? How does this compare with the expected audience size?
- What is the process to remove stale Published Data Sources?

Data Governance Summary

Striking the balance between control and agility is critical. In spite of stringent governance policies, users often go the route of locally saving sensitive data and analytics for quick analysis. In a self-service environment, the role of data governance is to permit access to data and enable users to get the answers they need while ensuring security is enforced. Although every organization has different requirements, the table below describes the ideal state for governing self-service data access:

Area	IT Administrators/ BI Professionals	Content AUTHORS
Data Source Management	Provide access to sources of data and comply with organizational data strategy, policies, and procedures.	Define, manage, and update data models used for analysis.
Data Quality	Define the process to validate data and build trust in its accuracy for decision making.	Capture and expose data-cleansing rules applied to published data models.

Area	IT Administrators/ BI Professionals	Content AUTHORS
Enrichment & Preparation	Create ETL processes from multiple sources of data to make data ready for analysis.	Capture and expose enrichment and preparation rules applied to published data models.
Data Security	Define security parameters and access controls to published data models.	Comply with enterprise data security policies and external regulations.
Metadata Management	Define organizational policies and processes for metadata management.	Define, update, and expose field-level metadata for users.
Monitoring & Management	Monitor and audit usage to ensure compliance and appropriate use of data assets.	Monitor and track usage metrics of centrally-managed data models.

Content Governance in Tableau

As the use of analytics increases, a growing number of mission-critical business decisions will become data-driven. The net effect is not only an increase in content volume but also in the varying skill levels among its users who will be collaborating and uncovering valuable insights. With more and more people using data daily, it is critical that Tableau content can be secured, governed, and trusted—as well as organized so that people can discover, consume, and create content with confidence. Without content governance, users will find it increasingly difficult to find what they need among irrelevant, stale, or duplicate workbooks and data sources.

Content governance involves the processes that keep content relevant and fresh, such as knowing when to decommission content because it's not getting the expected traffic or finding out why no one is using an important dashboard for decision-making. The responsibility of ensuring compliance with an organization's content governance policies is a core responsibility of content authors.

This section provides IT administrators and business users with the core concepts underpinning Tableau's content governance features and guidance on how these concepts should be applied to manage the content created in a thriving modern analytics platform.

Content Management

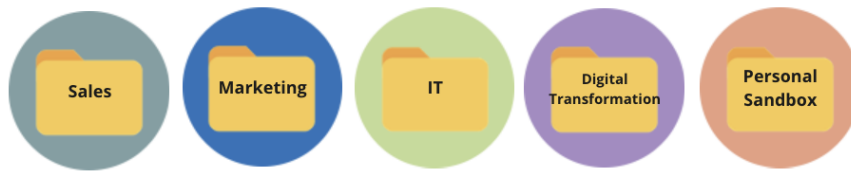
Defining a consistent content organization structure allows administrators to manage content and makes content more discoverable by users. Tableau Server and Tableau Cloud give you the flexibility needed to structure your environment and manage content based your specific governance requirements. Thoughtfully structuring your site will help you deliver true self-service analytics at scale and ensure the responsible use of data to enable your users to discover and share insights.

Projects

To share and collaborate, users will create and publish content to a project in Tableau Server or Tableau Cloud. Projects are the default containers used to organize and secure content, holding workbooks, data sources, flows, metrics, and other nested projects within them. This creates a scalable structure for managing access to the content published to Tableau.

Organizations are not flat, and neither is the way you govern your content. Projects and nested projects behave much like file system folders to provide hierarchical structures that gather related data and content with the users, groups, and corresponding permissions that mirror your business. Only administrators can create top-level projects, but it is easy to delegate nested projects to Project Owners or Project Leaders for their specific needs. Common content management approaches include organizational (by department/team), functional (by topic), or hybrid (combination of organizational and functional). When planning the content structure, the cross-functional Tableau team should establish consistent naming conventions for project and the groups who will have access to them.

For example, in the initial Tableau Server deployment, the Sales, Marketing, and IT departments will be onboarded. Following the organizational structure, top-level projects for each will be created for every department. The users in these three departments, also happen to be part of the cross-functional Digital Transformation team. Because digital transformation content spans multiple departments' users, a separate project named Digital Transformation will also be needed. The users from each of their respective departments will be part of a group who can access them. Users and groups only see projects to which they have access, so do not be concerned with the number of projects that you see as an administrator.

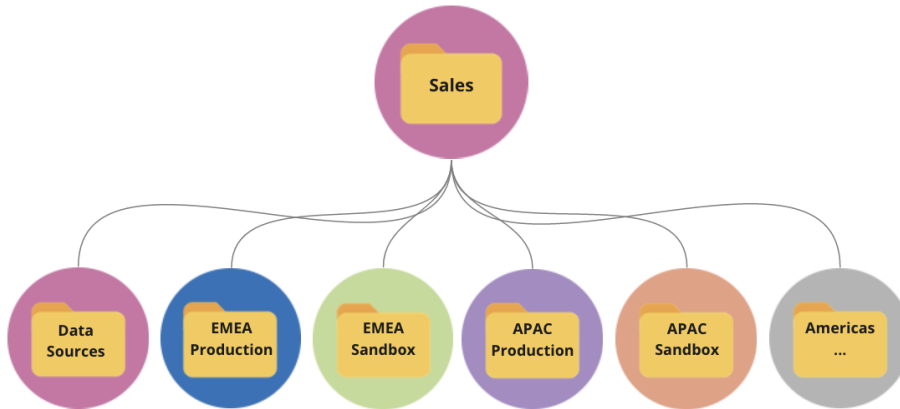


Sandbox and Certified Projects

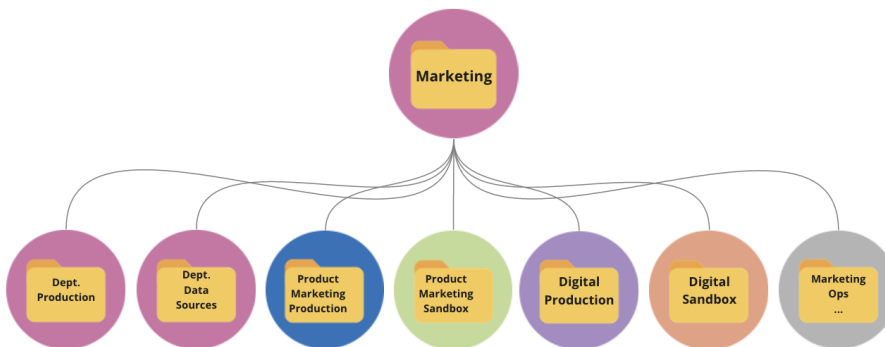
To support self-service, sandbox and production projects should be used. Sandbox projects contain ad hoc or uncertified content, and production projects contain validated, certified content. Users should understand the difference in purpose between these two project types. All content authors with access to a sandbox project can freely explore data, author content, and perform ad hoc analysis. The production project's validated and certified content means that there is a high degree of trust and confidence in it for data-driven decision making.

Publishing to the production project is limited to a small group of users who will validate, promote, and certify content for this location. These content management tasks should be delegated to users who are Project Owners and Project Leaders. For more information, see [Project Level Administration \(Tableau Server | Tableau Cloud\)](#). The roles and the process of content validation, promotion, and certification are described later in this topic.

The diagram below shows the Sales department's project hierarchy with a Sales Department Data Sources project, which holds department-wide data sources. The nested projects within the Sales department's project map to sales regions. Groups corresponding to the users within each region have access to the appropriate regional nested project. The content created by the regions will exist alongside nested projects within them, which will be used to organize and secure it as needed. Beginning with your organizational structure is an appropriate place to begin mapping out your Tableau content structure because departments likely already have security, data, and application access that correspond with their job functions.

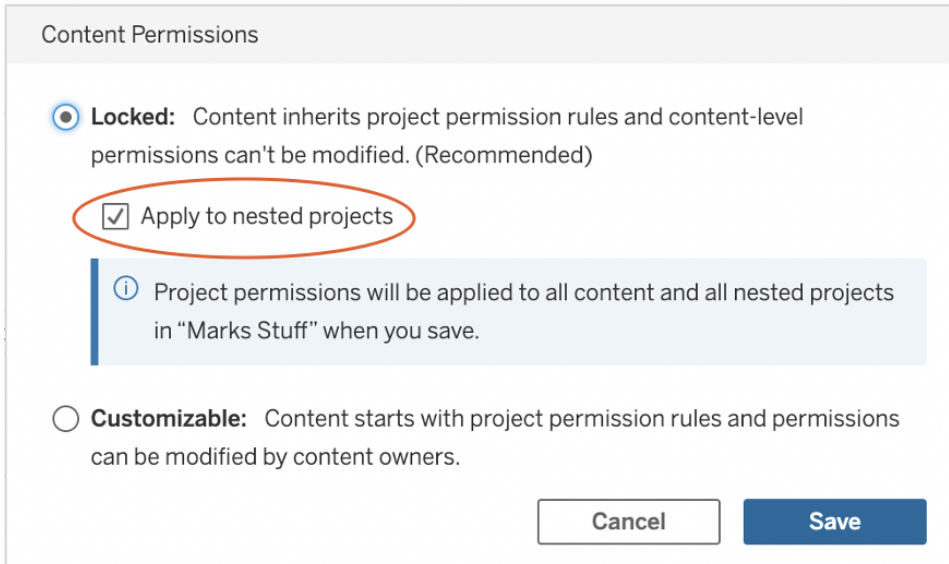


As a department-team example, Marketing branches out to accommodate shared resources such as department wide production content and data sources, but then lock down specific resources for a group such as Digital which has its own production and sandbox projects. The Marketing project hierarchy is shown below.



Permissions should be managed at the project level using locked projects and groups to enforce governed access to content and simplify administration. While it is possible to manage permissions at an item level with unlocked projects, they will quickly become unwieldy to manage. Locked projects secure data while providing collaboration across projects when you need it. For more information, see [Use Projects to Manage Content Access \(Windows | Linux\)](#).

With the introduction of locked nested projects in 2020.1, a project can be locked at any level in the project hierarchy regardless of whether the parent is locked with different permissions. Tableau Server and Site Administrators and Tableau Cloud Site Administrators can manage content and permissions more effectively by delegating content management responsibilities to Project Owners or Project Leaders, who are closer to the work. They will use the locked nested projects with the permissions model that meet their specific group needs at any level in the hierarchy.



Check **Apply to nested projects** to lock nested projects independently.

Collections

Collections, introduced in 2021.2, provide a virtual container for content. Think of Collections as a playlist like you would find in Spotify, giving you the ability to curate the combination of content you want to share with others. This functionality differs from Favoriting, which you can not share with others.

Getting started with Collections is easy and available for any Tableau user site role.

You can add most content types (e.g. Workbooks, Views, Metrics, Datasources, etc.) to a collection from anywhere across a single site regardless of its project location. It's a flexible way to onboard new team members, support your workflows, and share related content without moving or duplicating existing items. Item permissions are still enforced so only the appropriate users will see and have access to content that's in the collection.

There are many ways to use Collections as part of your organization's content management framework. Continuing the example above, imagine that your organization has multiple projects (Sales and Marketing). You want to give users the ability to easily find related content from across these projects so you create a Collection. Now teams can easily weave a complete picture around a topic from one place.

Personal Sandbox

To provide a place for all individuals to securely save their work on Tableau Server or Tableau Cloud, you should create a single personal sandbox and permissions to restrict content owners to

only viewing their own items. The personal sandbox can be used for ad hoc or in-progress analysis and hides the content that is not ready for broad release. When ready, users can move their content to the department sandbox for validation, promotion, and certification process. A single personal sandbox for all users reduces administrative overhead by reducing the number of projects to secure and manage. After creating a top-level project named “Personal Sandbox,” set the permissions on the project for All Users to Publish, **None** for workbooks, and **None** for data sources, **None** for Flows, and **None** for Metrics.

Permission Rules				
		Projects	Workbooks	Data Sources
Group/User	Template			
All Users	Publish			

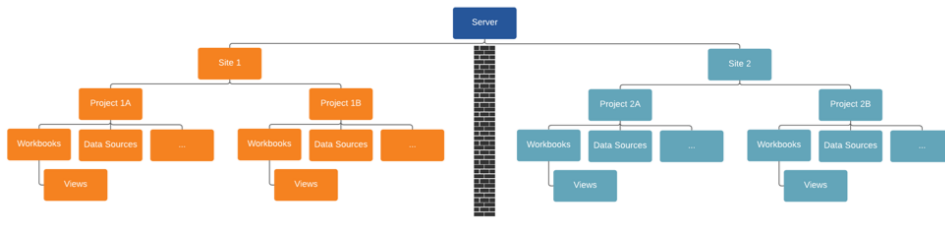
Publisher only permissions at the Project level only

With personal sandbox content in a single location, administrators can monitor how often content is viewed, suggest when owners should delete stale content, and check who is making the most use of the personal sandbox. Content owners can always see the content they own, even if it is published in a project where they are denied the ability to view workbooks and data sources. Authorization is explained in more detail in the next section.

Sites

Both Tableau Server and Tableau Cloud support multi-tenancy using sites. In Tableau Server, you can create multiple sites to establish a security boundary that isolates specific users, groups, data, and content on the same Tableau Server deployment. Users of one site do not have access to another site, including visibility of its existence. Because of the strict boundaries, sites work well when there is a deliberate need to prevent users from collaborating, or when content can remain separate during all phases of development.

For example, the diagram below shows two Tableau Server sites. In this example, unique users in Site 1 have no access to Site 2 including data and content. A user with access to both Site 1 and Site 2 can only sign into one site at a time. If some content is needed by both sites' users, it will need to be duplicated within each site, or a new site will need to be created for the shared content for these users, which creates a lot more administrative overhead to monitor, measure, and maintain. In Tableau Cloud, your instance of Tableau is a single site.



Sites create hard boundaries (see diagram above)

Sites in Tableau Server may initially appear to be a useful construct for segmenting data sources, workbooks, and users, but the security boundary prohibits collaboration and content promotion that most organizations need for true self-service at scale. For this reason, carefully consider the implications of using sites instead of projects in a single site with delegated content management responsibilities. To illustrate the hard boundaries across sites, when you stand up a new site, relevant data sources need to be re-created in the new instance.

New sites should only be created when you need to manage a unique set of users and their content separately from all other Tableau users and content because content is purposefully not shareable across the boundaries. For more information and examples of when it makes sense to use sites, see [Sites Overview \(Windows | Linux\)](#).

Key Considerations for Content Management

- Will workbooks and data sources be shared across the company?
- Will sites be used to isolate sensitive content or departments?
- Will projects use an organizational (departments/teams), functional (topics), or hybrid approach?
- Have sandbox and production projects been setup to support ad-hoc and validated content?
- Are content naming conventions used?
- Are authors publishing multiple copies of the same workbook with different filters selected?
- Does content have a description, tags, and comply with visual styles?
- Do you have a load time expectation and an exception procedure in place?
- After employees leave the company, what is the process to reassign content ownership?

Authorization

When a user attempts to login to Tableau, authentication verifies a user's identity. Everyone who needs access to Tableau Server must be represented as a user in Tableau Server's identity store ([Windows | Linux](#)). [Tableau Cloud Authentication](#) supports Tableau, Google, and SAML to verify

a user's identity. Authorization refers to how and what users can access on Tableau Server and Tableau Cloud after the user has been authenticated. Authorization includes:

- What users are allowed to do with content hosted in Tableau Server and Tableau Cloud, including site, projects, workbooks, views, data sources, and flows.
- What tasks users are allowed to perform to administer Tableau Server and Tableau Cloud, such as configuring server and site settings, running command line tools, creating sites, and other tasks.

Authorization for these actions is managed by Tableau Server and Tableau Cloud and determined by a combination of the user's license type, site role, and permissions associated with specific entities such as workbooks and data sources. Tableau's role-based licenses have implicit governance built in because of the capabilities that are included with them. For more information on specific capabilities by each license, see [Tableau for Teams and Organizations](#).

When you add users to a site on Tableau Server or Tableau Cloud, independent of their license type, you must apply a site role to them. The site role signifies the maximum level of access a user can have on the site.

Users with a Tableau Creator license have access to Tableau Server or Tableau Cloud, Tableau Desktop, Tableau Prep Builder, and Tableau Mobile. The following site roles use a Tableau Creator license:

Site Role	Description
Server Administrator	Available on Tableau Server only; not applicable to Tableau Cloud. Configure settings for the Tableau Server, all sites on the server, users and groups, and all content assets, such as projects, data sources (including connection information), workbooks, and flows. Connect to Tableau Published Data Sources or external data from the browser, Tableau Desktop, or Tableau Prep Builder; create and publish new data sources and flows; author and publish workbooks.
Site Administrator Creator	Unrestricted access to content as described above, but at the site level. Connect to Tableau or external data in the browser, Tableau Desktop, or Tableau Prep Builder; create new data sources; build and publish content. On Tableau Server, server administrators can determine whether to allow site administrators to manage users and assign site roles and site membership. By default, on Tableau Server, and always on Tableau Cloud, site administrators are allowed these capabilities.

Site Role	Description
Creator	This is the highest level of access for Tableau Cloud. Site Administrators have access to Site configuration settings.
	Connect to data to author new data sources and dashboards, which are published and shared on Tableau Server and Tableau Cloud. Data stewards (DBA or data analyst) publish data sources. Creators incorporate process definitions, policies, guidelines, and business knowledge for enterprise metadata management in compliance with organizational and/or regulatory obligations.

Users with a Tableau Explorer license have access to Tableau Server or Tableau Cloud and Tableau Mobile. The following site roles use a Tableau Explorer license:

Site Role	Description
Site Administrator Explorer	Same access to site and user configuration as Site Administrator Creator but cannot connect to external data from the web editing environment.
Explorer (Can Publish)	Connect to Tableau Published Data Sources to create new workbooks and edit and save existing workbooks.
Explorer	Publish new content from browser, browse and interact with published views, use all interaction features. In the web editing environment, can edit and save existing workbooks, and save new standalone data sources from data connections embedded in workbooks, but cannot connect to external data and create new data sources.
Explorer	Browse and interact with published views. Can subscribe to content, create data driven alerts, connect to Tableau Published Data Sources and open workbooks in the web authoring environment for ad-hoc queries, but they cannot save their work.

Users with a Tableau Viewer license have access to Tableau Server or Tableau Cloud and Tableau Mobile.

Site Role	Description
Viewer	View and interact with filters and content. Viewers can also receive alerts triggered by business events.

Users who have been added to Tableau Server or Tableau Cloud but without a license are Unlicensed.

Site Role	Description
Unlicensed	Unlicensed users cannot sign in to Tableau Server or Tableau Cloud.

Site roles along with content permissions determines who can publish, interact with, or only view published content, as well as who can manage the site's users and administer the site itself. The project team should work together to define the content permissions model. Tableau Server and/or Site Administrators will assign permission rules to groups and lock them to the project. Locked projects enforce permission rules on all content within the container, including nested projects. For more information, see [Set Project Default Permissions and Lock the Project](#).

Tableau has default permission rules for projects, workbooks, and data sources, or you can define custom permission rules for these content types.

Permission Rules Template	Description
Project Leader	Combined with the appropriate site role, allows the user or group full access to the project, its child projects, and content published into that project hierarchy.
Editor	Allows the user or group to connect to, edit, download, delete, and set permissions for data sources or workbooks in the project.

They can also publish data sources, and provided they are the owner of a data source they publish, can update connection information and extract refresh schedules. This permission is relevant for views when the view they access

Permission Rules Template	Description
	connects to a data source.
Publisher	Allows the user or group to publish workbooks and data sources to the project.
Connector	Allows the user or group to connect to data sources in the project.
Viewer	Allows the user or group to view the workbooks and views in the project.
None	Sets all capabilities for the permission rule to Unspecified.
Denied	Sets all capabilities for the permission rule to Denied.

Custom permissions allow more granularity in permissions—from accessing or downloading a data source to how a user interacts with published content. Tableau’s intuitive interface makes it easy to associate users to functional groups, assign permissions to the groups, and see who has access to which content. For more information, see [Set Permissions on Individual Content Resources](#). If Data Management is present, permissions for external assets have additional considerations. For more information, see [Manage Permissions for External Assets](#).

Permissions for Project "My Project"

Content permissions: Locked including nested projects [Edit](#)

Permission Rules

		Projects	Workbooks	Data Sources	Data Roles	Flows	Metrics
Group/User	Template						
All Users	View	✓	✓	✓	✓	✓	✓
Group	Explore	✓	✓	✓	✓	✓	✓
Evie	Publish	✓	✓	✓	✓	✓	✓
Lari	Administrator	✓	✓	✓	✓	✓	✓
Maris	Custom	✓	✓	✓	✓	✓	✗

[+ Add Group/User Rule](#)

Effective Permissions

Search for a user to view their effective permissions

User	Site Role						
Lari	Site Administrat...	✓	✓	✓	✓	✓	✓
Maris	Explorer (can pu...	✓	✓	✓	✗	✓	✗
Will	Unlicensed	✓	✗	✗	✗	✗	✗

Download Summary Data: Denied (by user rule)

You should create groups locally on the server or import from Active Directory/LDAP and synchronize ([Windows](#) | [Linux](#)) on a set schedule. Synchronization schedules are set by the Tableau Server Administrator or Tableau Cloud Site Administrators. To simplify maintenance, assign permissions to groups at the project level as shown below. For Tableau Cloud, you can [Automate User Provisioning and Group Synchronization in Tableau Cloud through an External Identity Provider](#) via SCIM and add or remove users or add or remove members from groups using the [REST API](#) programmatically.

For more information, see [Set-up Permissions Quick Start](#), [Configure Projects, Groups, and Permissions for Managed Self-Service](#), and [Permissions Reference](#).

Key Considerations for Authorization

- What is the minimum site role for Active Directory/LDAP or SCIM group synchronization?
- Have you set all permissions for the All Users group in the Default project to None?
- Are any explicit restrictions (Deny permissions) needed on the All Users group to propagate to every user account?
- Have you created groups that correspond to a set of authoring and viewing capabilities for each project?
- Have you reviewed effective permissions on select users to test your permissions model?

- Have you locked permissions at the parent project to maintain security throughout the project hierarchy?
- Have service account usernames/passwords been established for Published Data Sources?

Content Validation

Content validation is the first step in a series of events that will culminate in content certification. Similar to the data quality area in data governance, content validation encompasses the processes to validate that content is accurate, complete, reliable, relevant, and recent.

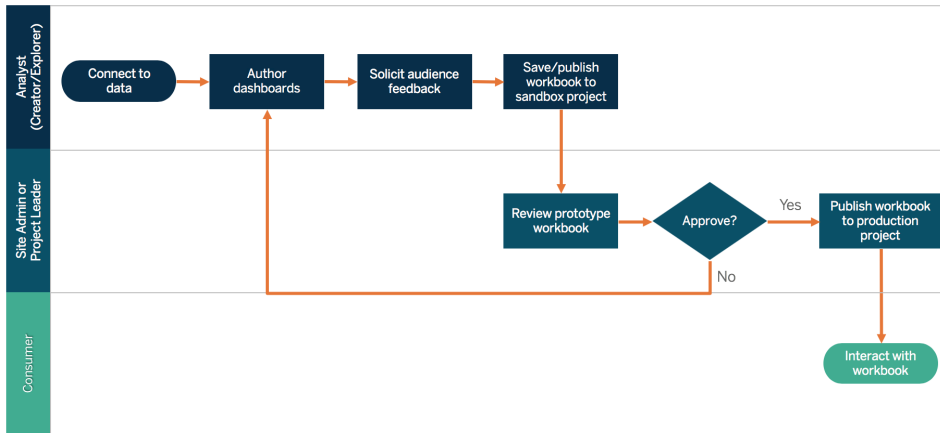
The first role to validate content should be its author. Authors should solicit feedback from the target audience as well. This can be done in an informal feedback group or by sharing a link to the workbook. Data stewards should also play a role to ensure correctness and review an embedded data source as a potential candidate for publishing and certifying. If the data source is embedded in the workbook, the data steward should consider whether it is a potential candidate for publishing and certifying. Beyond data and calculation correctness, content validation should also include a review of the branding, layout, formatting, performance, filters, dashboard actions, and edge case behaviors by the Site Administrator or Project Leader site roles.

Key Considerations for Content Validation

- Who is involved in the validation process?
- Is the workbook accurate, complete, reliable, relevant, and recent?
- Does the new content replace existing content?
- Are the underlying data and calculations correct?
- Does the workbook reflect corporate branding?
- Does the workbook have a logical layout?
- Are all axes and numbers formatted correctly?
- Do dashboards load within the acceptable performance time?
- Do filters and dashboard actions behave on the targeted views?
- Does the dashboard remain useful in edge case behaviors (filtered to all, none, one value, etc.)?

Content Promotion

After content validation is complete, the process of content promotion is used to publish the workbook to a trusted project location or add the certification badge designation for Published Data Sources. An example of a workbook workflow is shown below.



Workbook Workflow

Content authors will connect to data, create new dashboards, and publish to the sandbox project. Site Administrators or Project Leaders will validate and approve the content. The approved content will be published to the production project. The [Content Migration Tool](#), licensed as part of [Tableau Advanced Management](#), provides an easy way to promote or migrate content between Tableau Server projects. You can do this between projects on separate Tableau Server installations (for instance, between a development instance of Tableau Server and a product installation with appropriate licensing for each environment), or between projects on a single Tableau Server installation. The Content Migration Tool User Interface walks you through the steps necessary to build a "migration plan" that you can use a single time, or as a template for multiple migrations. To learn more about use cases, visit [Content Migration Tool Use Cases](#).

If IT requirements mandate three separately licensed environments (Dev, QA, and Production), try not to replicate a traditional waterfall development cycle with a modern analytics platform. Users may favor the QA environment to circumvent stringent policies or delays to get content into production, so work towards a good balance by automating content migration to the production server with custom workflow scripts using Tableau's REST APIs.

Key Considerations for Content Promotion

- Who is involved in the promotion process?
- Do content-promoting roles have a checklist of criteria to evaluate?
- Have you clearly delineated between certified content and ad-hoc content by projects?
- Is the process agile to support iterations and innovation?
- Do you have workflows to address both direct and restricted sources of data and workbooks?

Content Certification

After content has been validated and promoted, it achieves a trusted, certified status when a Site Administrator, Project Leader, or a Publisher (content author or data steward) with permission to the production project promotes the workbook or data source to the designated location.

Certification makes content discoverable by content consumers and improves data stewards' abilities to govern enterprise-wide data more effectively in Tableau by reducing the proliferation of duplicate workbooks and data sources.

Use the baseline requirements that were established in key considerations for content validation as the criteria for becoming certified. Content authors should have a clear understanding of how the certification process works from start to finish, and content consumers should know where certified content is published in the production project, as defined by your content management standards.

Data source certification enables data stewards to promote specific data sources in your Tableau deployment as trusted and ready for use. Certified Data Sources get preferential treatment in Tableau Server and Tableau Cloud search results and in our smart data source recommendations algorithm so that they are discoverable and easily reusable.

The screenshot shows the Tableau interface for a data source named "TFS-CurrentWorkItemWithParents". At the top, it displays the data source icon, name, and metadata: "By Oliver Jen", "30,147 views", "0 stars", "Extract: Jul 25, 2017, 1:37 PM", and "Certified by Graeme Britz". Below this, there are navigation tabs: "Connections 1", "Refresh Schedules 1", "Connected Workbooks 33", "Permissions", and "Details" (which is selected). The main content area is divided into sections with descriptions and action buttons:

- About:** Specialized datasource used for tracing parent-child lineage of work items down the TFSPortfolio Hierarchy (e.g. Epic>Feature...), regardless of the descendant level. The parent Epic, Feature, Feature Requirement, and Story attributes for each work item are included if present, as well as the backlog priority for parent. Cannot be used on nested epics or other similar structures. [Edit Description](#)
- Project:** Internal System and Data Resources [Move...](#)
- Owner:** Oliver Jen [Change Owner...](#)
- Tags:** curated, CurrentWorkItemWithParents, official, tfs, TFS, TFS-CurrentWorkItemWithParents [Edit Tags](#)
- Modified:** Jun 1, 2017, 9:46 AM [View Revision History...](#)
- Certification:** Certified by Graeme Britz [Edit Certification Status](#)

At the bottom right, there is a red button labeled "Delete Data Source..."

Certified Data Source

Key Considerations for Content Certification

- Who is responsible for designating certified content?
- Have all criteria for achieving certification status been met?
- Are all fields completed: about, certification notes, tags?

Content Utilization

Content utilization is a measurement of the effective use of the data for business decisions, but the complete picture cannot be told through Traffic to Views alone. Measurement of content utilization helps your deployment to operate at scale and evolve by understanding user behaviors—who creates and consumes content, and the quality and relevance of the dashboards and data sources. If content isn't being consumed, you will be able to identify it, and take the appropriate next steps.

Tableau Server Administrators and Tableau Cloud Site Administrators should monitor broad usage patterns with default administrative views. For more specific requirements, it is possible to create custom administrative views. For Tableau Server, this can be done with Tableau Server repository data. In Tableau Cloud, Site Administrators have access to [Monitor Site Activity](#) with default administrative views and can [Use Admin Insights to Create Custom Views](#). Site Administrators should measure and audit usage of published content—both certified and ad-hoc—within their site. For example, if ad-hoc content utilization is significantly higher than certified content utilization, perhaps the promotion process is too restrictive or takes too long for business needs.

Site Administrators should review content utilization in the context of the expected audience sizes that were documented on the [Tableau Use Cases and Data Sources](#) on page 45 tab of the [Tableau Blueprint Planner](#). Individual content authors should also review utilization for their content in the sparkline tooltip by hovering over the workbook's thumbnail or selecting Who Has Seen This View from the menu. For more information, see the [Measurement of Tableau User Engagement and Adoption](#) on page 233.

Key Considerations for Content Utilization

- How much traffic goes to each view?
- What is the definition of stale content? How often is stale content purged?
- How much indirect utilization (alerts & subscriptions) occurs?
- Are subscriptions delivered on time?
- Does the actual audience size match with expectations?
- Does content follow a weekly, monthly, quarterly trend?

- What is the frequency of login or days since last login by user cohort?
- What is the distribution of workbook and data source size?

Content Governance Summary

The table below defines the ideal state for promoting and governing content in a thriving modern analytics deployment:

Area	IT Administrators/BI Professionals	Content AUTHORS
Content Management	Create and maintain an environment for storing and organizing published content.	Ensure content is relevant in their site or project.
Security & Permissions	Secure analytic content and grant users the appropriate levels of access based on content type, sensitivity, business need, etc.	Comply with organizational security and permissions policies.
Content Validation	Define process for validating content is correct.	Access platform capabilities to assist with validation and accuracy verification of user-generated analytic content.
Content Promotion	Define process for promoting content.	Promote validated analytic content to centralized-trusted environment as determined by governance process.
Content Certification	Define process for certifying content.	Certify content as trusted and delineate from untrusted content in the same environment.

Area	IT Administrators/BI Professionals	Content AUTHORS
Content Utilization	Measure broad usage patterns across organizational business units.	Measure and audit usage of published content and track usage of untrusted content.

Tableau Governance Models

Acknowledging that every organization is different, and every use case is different, varying degrees of governance are required. The data and content governance models can be right-sized and applied to any kind of data regardless of where it falls in the governance spectrum. Establishing three primary governance models—centralized, delegated, and self-governing—provides the flexibility to satisfy the governance needs of most organizations.

Like other Tableau platform management activities, an agile, iterative approach is needed to adapt to new business requirements as user adoption and engagement increase across your organization. Processes will change over time as skills increase and responsibilities are delegated more broadly than the IT organization. Establish governance review points twice a year to continue to evolve the models.

The Data and Content Governance tab in the [Tableau Blueprint Planner](#) will help you to define your organization's governance models based on information collected in the [Tableau Enterprise Architecture Survey on page 36](#) and [Tableau Data and Analytics Survey on page 42](#). You should establish and document who is responsible and what processes support each area within each model: centralized, delegated, and self-governing.

Using the matrix approach to separate data and content governance and segmenting by the three models, it is easy to mix and match across models. For example, data and content governance may be centralized at the start. Then, after user training, data governance areas may be centralized, but content governance is delegated or self-governing because the data is curated. Similarly, specific areas within data and content governance can be tailored, such as delegated metadata management and centralized security and permissions, to meet your unique requirements. As business users' analytical capabilities grow, more responsibilities can be delegated over time. Once defined, the governance models should be communicated with

the user community by publishing them to the enablement intranet. For more information, see [Tableau Enablement Intranet on page 277](#).

Centralized

In a centralized model, IT or another authority owns data access and produces data sources and dashboards for business consumption in a one-to-many manner by a small number of Creators and everyone else as Viewers. Centralized governance is required for maintaining control of highly sensitive data.

Addressing a skills gap among the target audience is another case where centralized management is necessary. You can still provide business users with prepared content to make data-driven decisions while they build their analytical capabilities.

If you are transitioning from a traditional, top-down analytics approach driven by IT or favor a phased delegation of responsibilities to governed self-service, it may be advantageous for IT or a centralized BI team to build the initial use cases across departments, including Certified Data Sources and dashboards.

Over time, as users are encouraged to ask and answer their own questions, the domain of available trusted content will grow organically with the teams and departments, and users will have access to a wider range of analytic content for self-service. To avoid the risk of recreating a “report factory” delivery model, establish goals and dates to evolve beyond the centralized governance model and to begin delegation of responsibilities.

Delegated

In a delegated governance model, new roles are introduced outside of IT or a central authority. Site Administrators and Data Stewards are identified and may have direct access to sources of data. Content authors have access to certified Published Data Sources to ask and answer their own business questions, while some content consumers are given web authoring capabilities to save derivative content to sandbox projects. Processes to validate, promote, and certify content are introduced but still may be limited. There is increasing collaboration between IT and business users as IT shifts from a provider of reports to an enabler of analytics.

Self-Governing

In a self-governing model, there is strong collaboration between IT and business users. Certified content and data sources are available, and ad-hoc content is being created regularly by

Creators and Explorers. Viewers understand the delineation between certified and ad-hoc, sandbox content states. The process of validation, promotion, and certification is well-defined and well-understood by users of all skill levels. With increasing analytical skills across the organization, the boundaries between the roles of the Modern Analytics Workflow are fluid as users switch from consuming to creating to promoting content with the appropriate level of permissions.

Tableau Deployment

Prioritizing data and analytics couldn't come at a better time. Your company, no matter what size, is already collecting data and most likely analyzing just a portion of it to solve business problems, gain competitive advantages, and drive enterprise transformation. With the explosive growth of enterprise data, database technologies, and the high demand for analytical skills, today's most effective IT organizations have shifted their focus to enabling self-service by deploying and operating Tableau at scale, as well as organizing, orchestrating, and unifying disparate sources of data for business users and experts alike to author and consume content.

Tableau prioritizes choice in flexibility to fit, rather than dictate, your enterprise architecture. Tableau Server and Tableau Cloud leverage your existing technology investments and integrate into your IT infrastructure to provide a self-service, modern analytics platform for your users. With on-premises, cloud, and hosted options, there is a version of Tableau to match your requirements. Below is a comparison of the three types:

Type	Pros	Cons
Tableau Server - On Premises	<ul style="list-style-type: none"> Full control of hardware and software Infrastructure and data remain behind your firewall 	<ul style="list-style-type: none"> Need dedicated administrators to manage hardware and software Additional infrastructure needed to access off-network (mobile, external)
Tableau Server - Public Cloud (IaaS)	<ul style="list-style-type: none"> Full control of software on managed hardware Puts infrastructure in same place as data (for migration to cloud) Flexibility to spin up/down hardware as needed 	<ul style="list-style-type: none"> Need dedicated administrators to manage software Additional infrastructure needed to access off-network (mobile, external)
Tableau Cloud (SaaS)	<ul style="list-style-type: none"> Fully hosted solution (hardware, software upgrades) Fast to deploy Easy for external audience to access 	<ul style="list-style-type: none"> Single-site in multi-tenant environment Cubes are not supported No guest account access

During the discovery stage, IT completed the [Tableau Enterprise Architecture Survey on page 36](#) for the corresponding deployment type and collected the [Tableau Data and Analytics Survey on page 42](#) from departments and teams within your organization. The Enterprise Architecture Survey helps you identify your enterprise standards and processes for technology and platforms that you will integrate with Tableau.

Depending on your organizational roles and responsibilities, Tableau Server should be installed by a systems administrator and the designated Tableau Server Administrator in coordination with the appropriate IT roles. For Tableau Cloud, you will integrate with your existing technology and configure the site settings. The Data & Analytics Survey, completed by business teams, identifies and prioritizes data use cases, audience size, and users. You will use the information collected in both surveys to plan your deployment strategy, including sizing, installation, and configuration of your Tableau Server or integration and configuration of Tableau Cloud. In addition to installing Tableau Server or configuring Tableau Cloud, administrators will also need to plan for the client software installation of Tableau Prep Builder, Tableau Desktop, Tableau Mobile, and Tableau Bridge for Tableau Cloud where applicable.

This document covers system integration and deployment best practices. It will help you plan your deployment strategy. Prior to Tableau Server installation, review Planning ([Windows](#) | [Linux](#)) and Baseline Configurations ([Windows](#) | [Linux](#)). For full documentation, visit Get Started with Tableau Server ([Windows](#) | [Linux](#)). Enterprise IT Administrators should also visit the [Tableau Server Enterprise Deployment Guide](#), which provides prescriptive deployment guidance for enterprise scenarios in the context of a reference architecture. The reference architecture reflects industry-standard enterprise deployments. We have tested the reference architecture to verify compliance with security, scale, and performance benchmarks, which confirm to industry-standard best practices.

For Tableau Cloud site configuration and administration, visit [Administer a Site](#).

Tableau Platform Architecture

Tableau Server

Tableau Server provides a full modern analytics platform for your users. Tableau's architecture is flexible, allowing you to run the platform just about anywhere. You can install Tableau Server on-premises, in your private cloud or data center, on Amazon EC2, Google Cloud Platform, MS Azure, or Alibaba Cloud. Tableau Server can also run on virtualization platforms.

Multiple server processes work together to provide services in various tiers. To learn how the processes work together, see [Tableau Server Processes](#) on Tableau Public. Because Tableau Server integrates with a number of components in your IT infrastructure, it's important to understand how Tableau Server integrates with your IT infrastructure. For more information on processes, see [Tableau Server Processes \(Windows | Linux\)](#). To learn more about Tableau Server processes as deployed in the reference architecture for the minimal enterprise-appropriate Tableau Server deployment, visit Part 2 of the Tableau Server Deployment Guide: [Part 2 - Understanding the Tableau Server Deployment Reference Architecture](#).

Tableau Cloud

Tableau Cloud is a software-as-a-service (SaaS) deployment built to scale to serve thousands of sites with thousands of geographically distributed users within a multi-tenant (shared compute) environment. Tableau Cloud takes advantage of high availability features available in the product and cloud architecture best practices to deliver a reliable experience. Tableau Cloud supports a hybrid data architecture with a mix of networks, including on-premises, private cloud, and public cloud. The following diagram is a high-level illustration of Tableau's internal deployment of Tableau Cloud:

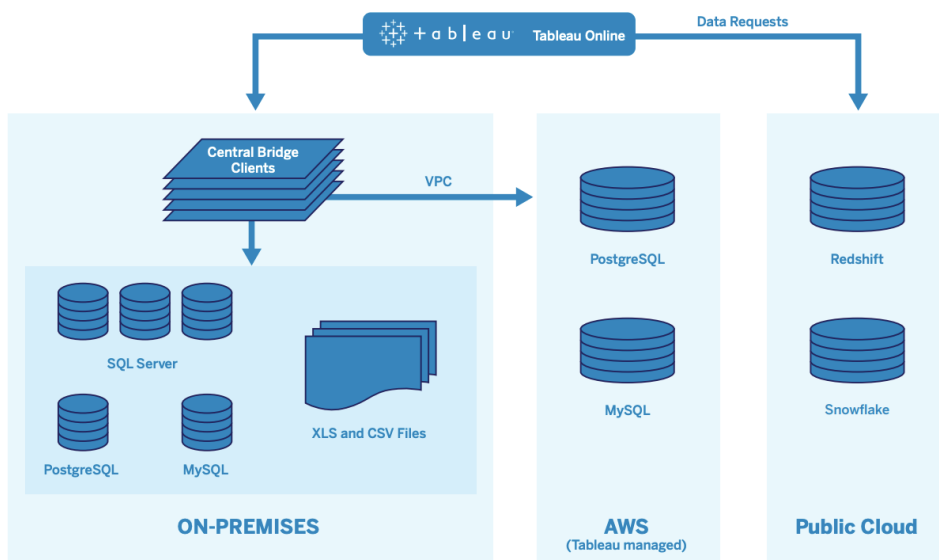


Tableau manages many different data sources, including SQL Server, PostgreSQL, MySQL, Redshift, Snowflake, Google Big Query, and flat files across various networks. Public Cloud data connections are generally made directly. For private connections, a pool of Tableau Bridge

services facilitates the live on-premises or VPC database query capabilities, and scheduled extract refreshes.

For more information, see:

- [Tableau Cloud Scalability whitepaper](#)
- [Direct Connections to Cloud Data](#)
- [Getting Started with Tableau Bridge](#)
- [Plan Your Bridge Deployment](#)

Hardware Platform

Note: This topic applies to Tableau Server only.

Tableau Server can be installed on-premises with physical or virtual machines or in the cloud and supports Windows or Linux operating systems. To determine your hardware platform and sizing, consider these variables: your environment, sources of data and management to provide self-service data access, potential workload from all users, and actual usage data. If this is the first time you are deploying Tableau Server, you should focus on your environment standards and sources of data. For existing deployments, you will analyze Tableau Server data to evaluate workload and usage in addition to environment and sources of data.

Hardware requirements

Regardless of where you choose to deploy Tableau Server, properly-sized hardware is critical. Your planning should be aligned with evolving business needs by assessing server utilization and user engagement more frequently, scaling more frequently, and changing topology more frequently than other software applications. Review the corresponding link to the hardware platform that fits your enterprise standards:

- [Recommended Baseline Configurations \(Windows | Linux\)](#)
- [Tableau Server on VMware vSphere](#)
- [AWS Instance Type and Size \(Windows | Linux\)](#)
- [Google Compute Engine Virtual Machine Type and Size \(Windows | Linux\)](#)
- [Microsoft Azure Virtual Machine Type and Size \(Windows | Linux\)](#)
- [Alibaba Cloud ECS Instance Type and Size \(Windows | Linux\)](#)

If you deploy Tableau Server in the cloud, using Dedicated Hardware and static allocation of RAM eliminates varied performance due to resource contention. If cost is a consideration, Virtual Hardware is also viable. We recommend testing your own infrastructure to find the configuration that best fits your needs. For an example of how to conduct such a test, please see the [Tableau at the Speed of EC2 Whitepaper](#). (This experiment was conducted in AWS, but the testing theory extends to any cloud provider.)

Initial Sizing

Your Tableau account team is available to assess your requirements and assist with sizing. In an initial deployment of Tableau, you should estimate 600-800 Explorers per 8-core node, assuming 10% active users (interactive, concurrent requests made to Tableau Server, including consuming dashboards on a laptop or mobile device, web authoring, and connecting to and querying Published Data Sources). This is only a starting point and should not be considered a hard sizing rule beyond the initial deployment. Memory should be at least 8GB of RAM per core for a production server. For less than 40-core clusters, use 8-core nodes, and in clusters greater than 40-cores, use 16-core nodes. The relative workload of each license type must be factored into hardware sizing. Assuming an Explorer counts as 1 user, a Creator has a relative workload of 2.4 users, while a Viewer has a relative workload of 0.75 of a user. Using these workload coefficients, you can estimate the cluster's capacity. The following table shows examples of equivalent workloads on each row:

	Creators	Explorers	Viewers
Workload 1	25	300	586
Workload 2	50	333	462
Workload 3	75	234	514
Workload 4	100	171	518

Actual workload of Creators, Explorers, and Viewers may vary with usage of Tableau Server features, such as frequency of connecting to data and web authoring, as well as viewing and interacting with content. As users are onboarded and start creating and consuming content, you should monitor the hardware and content utilization to make informed decisions on server sizing with data from hardware monitoring tools and Tableau Server's Repository. For more information, see [Tableau Monitoring on page 183](#) and [Measurement of Tableau User Engagement and Adoption on page 233](#)

Scalability

In both new and existing deployment scenarios, the goal is to proactively maintain sufficient availability, capacity, and headroom and minimize resource contention. Like other enterprise platforms, Tableau Server scales up by adding processor, memory, and/or disk or scales out by adding more nodes to a cluster. Tableau Server scales nearly linearly with the addition of hardware resources, according to your unique environment, data, workload, and usage mix. Load testing and capacity planning should be conducted regularly, as outlined in [Tableau Maintenance on page 201](#).

Scalability and performance are heavily dependent on external systems, such as sources of data, volume of data, and network speeds, user workloads, and workbook design, which can change rapidly as deployments progress. For example, assuming a correctly-sized hardware configuration for the initial deployment, unplanned user onboarding, unmonitored utilization, inefficient workbooks, suboptimal data extract design, and peak-hour refresh schedules can have a major impact on server performance and user experience, causing performance to degrade from the cumulative effect of the separate incidents. For more information, see [Tableau Server Scalability whitepaper](#).

When deploying Tableau Server in the cloud, you can leverage all existing scaling abilities of the Tableau platform including [Hot Topology](#). With a simple restart of the server, you can also change the underlying machines supporting the platform as long as their Public IP Address does not change.

For single-node deployments, you may also turn off Tableau Server machines during downtimes to reduce machine costs. Doing so with a multi-node cluster will put Tableau in a degraded state. But you can utilize [Hot Topology](#) to responsively adjust Tableau Server process allocation, allowing you to tune the balance of machine costs and capacity needs. Auto-scaling functionality that terminates or instantiates machines based on demand is not supported.

Server Environments

In addition to your production environment, Tableau recommends one test environment for testing upgrades and server topology changes. Your production environment will support modern analytics using production and sandbox projects with content validation, promotion, and certification processes—all in one environment. For more information on these content management processes, see [Tableau Governance on page 79](#). The production and test environments should have identical hardware specs, server topology, and configuration. This

will allow administrators to test upgrades and participate in beta programs in the test environment by restoring back production content.

Some organizations have IT policies that require three environments—Development, QA, and Production—to isolate use cases for content development, testing and consumption into separate Tableau Server installations. If this is a requirement for your organization, each of the three environments must be licensed separately as they would be considered three Production Environments as defined in Tableau's End User License Agreement. The Production and QA environments should have identical specs, server topology, and configuration. If you are required to run three separate environments, try not to replicate a traditional waterfall development cycle with a modern analytics platform. Users may favor the QA environment to circumvent stringent policies or delays to get content into production, so work towards a good balance by automating content migration to the production server with the [Content Migration Tool](#) found in [Tableau Advanced Management](#) or custom workflow scripts using Tableau's REST APIs. The development environment does not have to have identical hardware specs as the production and QA environments, unless the development environment is used for upgrade testing or participation in beta programs.

High Availability

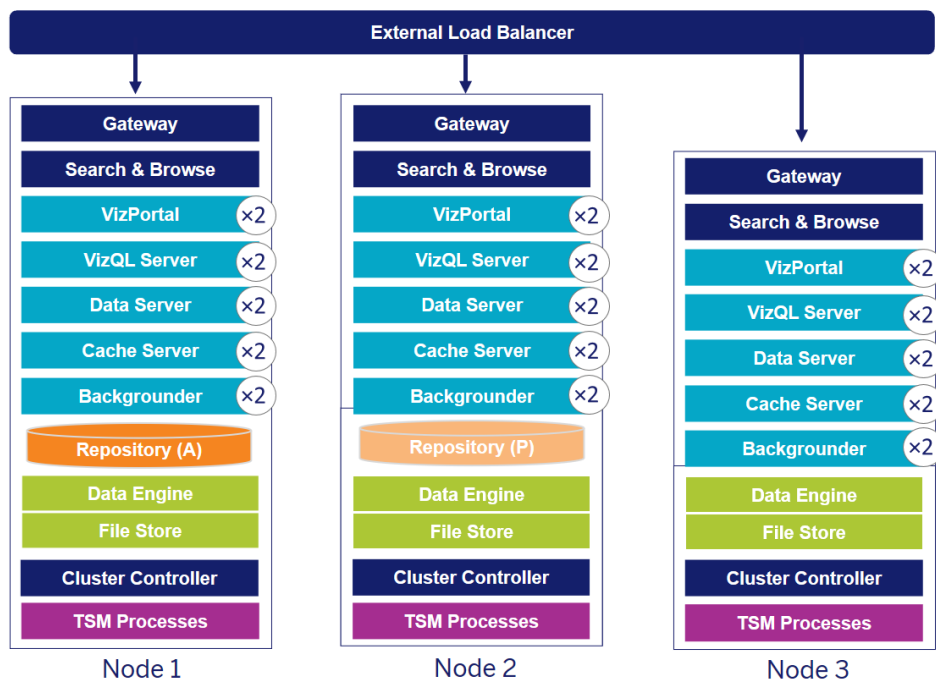
You should install and configure Tableau based on your availability requirements and add additional nodes for capacity and/or for high availability ([Windows](#) | [Linux](#)). To support mission-critical use cases, you should deploy a high-availability (HA) cluster configuration with an external load balancer ([Windows](#) | [Linux](#)).

An HA installation of Tableau Server has a minimum of three nodes and multiple redundant instances of key processes (the Repository, File Store/Data Engine, and Coordination Service) on different nodes. The goal is to minimize system downtime by eliminating single points of failure and enabling detection of failures with failover where possible. For more information, see [Tableau Server High Availability whitepaper](#).

Follow the pattern below to build your HA cluster:

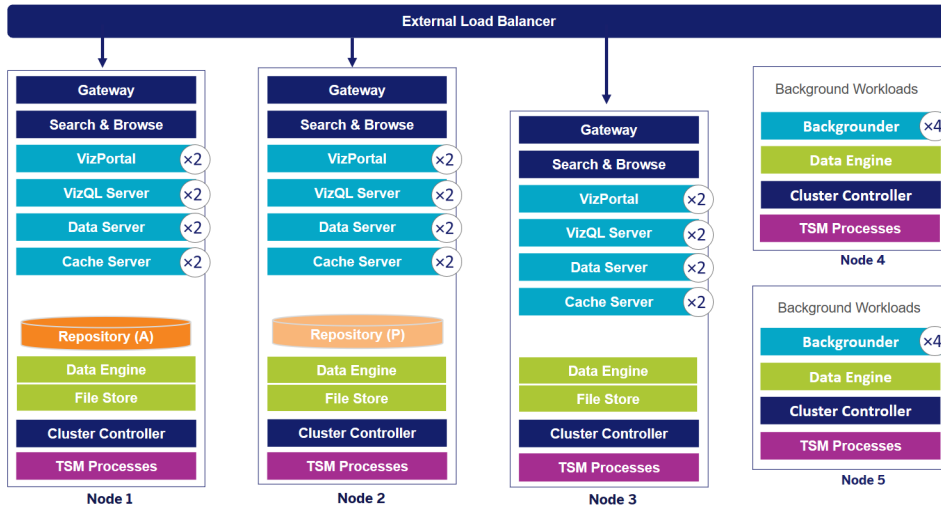
1. Install the initial node and allow the architecture-aware smart installer to configure processes ([Windows](#) | [Linux](#)). The active Repository is on Node 1.
2. Replicate the process configuration to other VizQL nodes, ensuring redundancy ([Windows](#) | [Linux](#)). The passive Repository is on Node 2. Node 3 processes will mirror Nodes 1 and 2, except there will be no Repository process on it.

3. Add Coordination Service Ensemble and Client File Service ([Windows](#) | [Linux](#)).
4. Add the external load balancer ([Windows](#) | [Linux](#)).



A 3-Node Tableau Server HA Deployment (Note: Coordination Service and Client File Service are not explicitly shown)

The need for specialized nodes evolves over time. Extract-heavy and frequent extract refresh workloads should be isolated from the interactive visualization-rendering workload. In an extract-heavy environment, most of data sources are extracts. Having a few extremely large extracts could put your deployment in this category, as would having many small extracts. Deployments where extracts are frequently refreshed, such as several times a day during business hours, should be isolated on specialized Backgrounder nodes. To isolate the workload of the Backgrounder process, add specialized Backgrounder nodes, ensuring redundancy, as shown in Nodes 4 and 5 below. Using node roles, you can configure where certain types of workloads are processed on your Tableau Server installation. The node roles features allows you to dedicate and scale resources to specific workloads. For more information on configuring node roles for Backgrounder and File Store, see [Workload Management through Node Roles](#).



A 5-Node Tableau Server HA Deployment (Note: Coordination Service and Client File Service are not explicitly shown)

Starting in 2019.3, you can deploy Tableau Server Repository to Amazon Relational Database Service (RDS). The Tableau Server Repository is a PostgreSQL database that stores data about all user interactions, extract refreshes, and more. Amazon RDS offers scalability, reliability, high availability and security built-in for PostgreSQL. By integrating with AWS to configure Tableau Server external repository, you will be able to take advantage of these additional benefits of deploying the cloud. For more information, see [Tableau Server External Repository](#).

When deploying Tableau Server in the public cloud, you have a few options to further mitigate risk of downtime. For example; deploying each node of Tableau Server in its own Virtual Network or in different Availability Zones/Zones are both supported. However, separating your environment could come at the expense of increased latency across the system. Before finalizing your environment, consider testing both performance and availability to ensure you have the appropriate balance for your data community. Tableau Server does not support deploying a multi-node cluster across different Regions.

Disaster Recovery

When planning for disaster recovery (DR) in your Tableau environment, there are two main factors to consider: Recovery Time Objective (RTO) and Recovery Point Objective (RPO). The RTO is a measure of how much downtime your business can accept before a full recovery, and it influences how often you restore your backups to an alternative cluster and the amount of infrastructure investment. The RPO, a measure of how much data loss your business can

tolerate, influences how often you will need to take backups of your system. For Tableau Server the RPO cannot be shorter than the time it takes to complete a full backup of your server. The table below illustrates how to plan for a range of RTO requirements:

High RTO	Medium RTO	Low RTO
New hardware/VMs obtained in case of an outage	Machines are provisioned but not running	Dedicated hardware that is always running with identical configuration and topology as production
Install Tableau Server	Tableau Server installed	Backups are restored regularly to the DR environment
Restore backup to the new environment	Restore latest backup to the cold standby environment	External load balancer/DNS routing that can be updated to point to the DR environment
Several hours or days	A few hours	Within minutes

Whether you host Tableau Server on premise or in the cloud, the backup process is the same. Use the [TSM Backup](#) command to generate a backup of the Tableau Server and restore that backup on a new machine. Taking a snapshot of a Tableau Server machine, and restoring on a new machine is not supported. For more information, see [Mission-Critical Reliability](#) for high-availability and disaster recovery concepts and whitepapers.

Authentication and Authorization

Tableau provides the comprehensive features and deep integration to address all aspects of enterprise security. For more information, see [Tableau Server Platform Security](#) and [Tableau Server Security Hardening Checklist \(Windows | Linux\)](#) or [Tableau Cloud Security in the Cloud](#).

Identity Store

Tableau Server requires an identity store ([Windows](#) | [Linux](#)) to manage user and group information. There are two kinds of identity stores: local (Tableau Server) and external (Active Directory, LDAP). When you install Tableau Server you must configure either a local identity

store or an external identity store. For information about configuration options for the identity store, see [identityStore Entity](#).

When you configure Tableau Server with a local identity store, all user and group information is stored and managed in the Tableau Server Repository. In the local identity store scenario, there is no external source for users and groups. Note: Changing the identity store after server installation requires a full [uninstall and reinstall](#).

When you configure Tableau Server with an external store, all user and group information is stored and managed by an external directory service. Tableau Server must synchronize with the external identity store so that local copies of the users and groups exist in the Tableau Server Repository, but the external identity store is the master source for all user and group data. When users sign in to Tableau Server, their credentials are passed to the external directory, which is responsible for authenticating the user ([Windows](#) | [Linux](#)). Tableau Server does not perform this authentication; however, the Tableau user names stored in the identity store are associated with rights and permissions for Tableau Server. After authentication is verified, Tableau Server manages user access (authorization) for Tableau resources.

Authentication

Authentication verifies a user's identity. Everyone who needs to access Tableau Server or Tableau Cloud—whether to manage the server or site, or to publish, browse, or administer content—must be represented as a user in the Tableau Server identity store or provisioned as a Tableau Cloud user. The method of authentication may be performed by Tableau Server or Tableau Cloud (local authentication), or authentication may be performed by an external process. In the latter case, you must configure Tableau Server for external authentication protocols such as Active Directory, OpenLDAP, SAML, or OpenID or configure Tableau Cloud for Google or SAML.

Authentication in Tableau Cloud

Tableau Cloud supports the following authentication types, which you can configure on the Authentication page. For more information, see [Tableau Cloud Authentication](#).

- **Tableau:** This is the default authentication type, available on all sites, requiring no additional configuration steps before you add users. Tableau credentials are made up of user-name and password, which are stored with Tableau Cloud. Users enter their credentials directly on the Tableau Cloud sign-in page.

- **Google:** If your organization uses Google applications, you can enable Tableau Cloud to use Google accounts for single sign-on (SSO) via OpenID Connect. When you enable Google authentication, users are directed to the Google sign-in page to enter their credentials, which are stored by Google.
- **SAML:** Another way to use SSO is through SAML. To do this, you use a third-party identity provider (IdP), and configure the site to establish a trust relationship with the IdP. When you enable SAML, users are directed to the IdP's sign-in page, where they enter their SSO credentials, already stored with the IdP.

Tableau Cloud Multi-Factor Authentication Requirement

In addition to the authentication type you configure for your site, multi-factor authentication (MFA) through your SSO identity provider (IdP) is a Tableau Cloud requirement beginning February 1, 2022. If your organization doesn't work directly with an SSO IdP, you can use Tableau with MFA authentication to meet the MFA requirement. For more information, see [About multi-factor authentication and Tableau Cloud](#).

Authentication in Tableau Server

The table below shows which Tableau Server authentication methods are compatible with which identity stores.

Authentication Method Local Authentication AD/LDAP

SAML	Yes	Yes
Kerberos	No	Yes
Mutual SSL	Yes	Yes
OpenID	Yes	No
Trusted Authentication	Yes	Yes

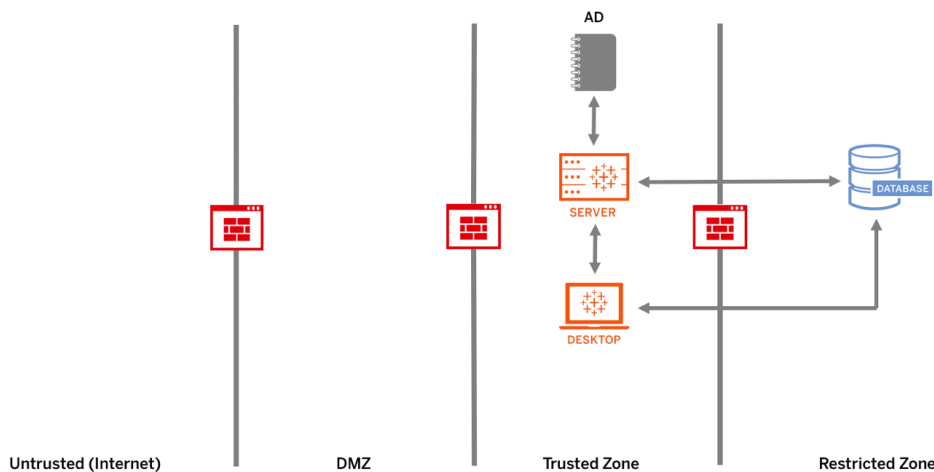
Active Directory & OpenLDAP

In this scenario, Tableau Server must be installed in a domain in Active Directory. Tableau Server will sync user and group metadata from Active Directory to the identity store. You do not have to manually add users. However, after the data is synchronized, you will need to assign

site and server roles. You can assign these individually, or at the group level. Tableau Server does not synchronize any data back to Active Directory. Tableau Server manages content and server access according to the site role permission data is stored in the Repository.

If you are already using Active Directory to manage users in your organization, you must select Active Directory authentication during Tableau setup. For example, by synchronizing Active Directory groups, you can set minimum site role Tableau permissions for users that are synchronized in the groups. You can synchronize specific Active Directory groups, or you can synchronize them all. For more information, see [Synchronize All Active Directory Groups on the Server](#). Be sure to review [User Management in Active Directory Deployments](#) to understand how multiple domains, domain naming, NetBIOS, and Active Directory user name format influence Tableau user management.

You can also configure Tableau Server to use LDAP as a generic way to communicate with the identity store. For example, OpenLDAP is one of several LDAP server implementations with a flexible schema. Tableau Server can be configured to query the OpenLDAP server. See [Identity Store](#). Authentication in this scenario maybe be provided by the native LDAP solution, or with a single sign-on solution. The diagram below shows Tableau Server with Active Directory/OpenLDAP authentication.



SAML

SAML (Security Assertion Markup Language) is an XML standard that allows secure web domains to exchange user authentication and authorization data. You can configure Tableau Server and Tableau Cloud to use an external identity provider (IdP) to authenticate users over SAML 2.0.

Tableau Server and Tableau Cloud support both service provider initiated and IdP initiated SAML in browsers and in the Tableau Mobile app. Connections from Tableau Desktop require that the SAML request must be service provider initiated. No user credentials are stored with Tableau Server or Tableau Cloud, and using SAML enables you to add Tableau to your organization's single sign-on environment. User authentication through SAML does not apply to permissions and authorization for Tableau Server or Tableau Cloud content, such as data sources and workbooks. It also does not control access to underlying data that workbooks and data sources connect to.

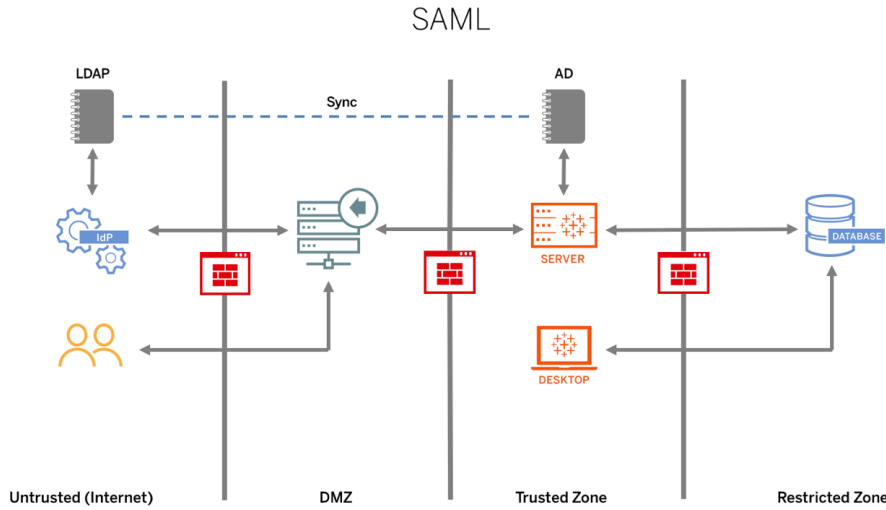
For Tableau Server, you can use SAML server-wide, or you can configure Tableau Server sites individually. Here's an overview of those options:

- Server-wide SAML authentication. A single SAML IdP application handles authentication for all Tableau Server users. Use this option if your server has only the Default site.

In addition, if you want to use Tableau Server site-specific SAML, you must configure Tableau Server-wide SAML before you configure individual sites. Tableau Server-side SAML does not need to be enabled for Tableau Server site-specific SAML to function, but it must be configured.

- Server-wide local authentication and site-specific SAML authentication. In a multi-site environment, users who are not enabled for SAML authentication at the site level can sign in using local authentication.
- Server-wide SAML authentication and site-specific SAML authentication. In a multi-site environment, all users authenticate through a SAML IdP configured at the site level, and you specify a server-wide default SAML IdP for users that belong to multiple sites.

For more information, see SAML ([Windows](#) | [Linux](#)). The diagram below shows Tableau Server with SAML authentication.



To configure SAM for Tableau Cloud, see the following requirements:

- [Identity provider \(IdP\) requirements for Tableau configuration](#)
- [SAML compatibility notes and requirements](#)
- [Using SAML SSO in Tableau client applications](#)
- [Effects on Tableau Bridge of changing authentication type](#)
- [XML data requirements](#)

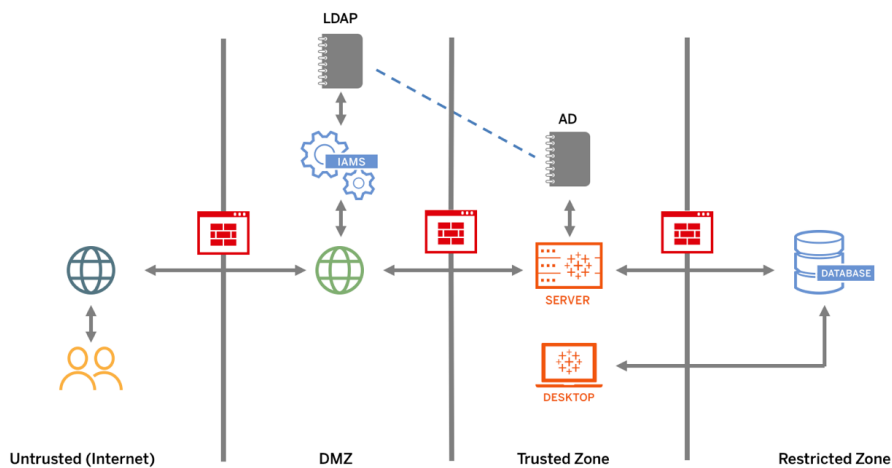
NOTE: In addition to these requirements, we recommend that you dedicate a Tableau Cloud Site Administrator account that is always configured for Tableau authentication. In the event of an issue with SAML or the IdP, a dedicated TableauID account ensures that you always have access to your Tableau Cloud site.

Trusted Tickets

If you embed Tableau Server views into webpages, everyone who visits the page must be a licensed user on Tableau Server. When users visit the page, they are prompted to sign in to Tableau Server before they can see the view. If you already have a way of authenticating users on the webpage or within your web application, you can avoid this prompt and save your users from having to sign in twice by setting up trusted authentication.

Trusted authentication simply means that you have set up a trusted relationship between Tableau Server and one or more web servers. When Tableau Server receives requests from these trusted web servers it assumes that your web server has handled whatever authentication is necessary.

If your web server uses SSPI (Security Support Provider Interface), you do not need to set up trusted authentication. You can embed views and your users will have secure access to them as long as they are licensed Tableau Server users and members of your Active Directory ([Windows](#) | [Linux](#)). The diagram below shows Tableau Server with Trusted Tickets.



Mutual SSL

Using mutual SSL, you can provide users of Tableau Desktop and other approved Tableau clients a secure, direct-access experience to Tableau Server. With mutual SSL, when a client with a valid SSL certificate connects to Tableau Server, Tableau Server confirms the existence of the client certificate and authenticates the user, based on the user name in the client certificate. If the client does not have a valid SSL certificate, Tableau Server can refuse the connection. You can also configure Tableau Server to fall back to username/password authentication if mutual SSL fails.

Authorization

Authorization refers to how and what users can access on Tableau Server or Tableau Cloud after authentication has been verified. For more information, see [Governance in Tableau on page 81](#). Authorization includes:

- What users are allowed to do with content hosted on Tableau Server or Tableau Cloud, including projects, sites, workbooks, and views.
- What users are allowed to do with the data sources that are managed by Tableau Server or Tableau Cloud.

- What tasks users are allowed to perform to administer Tableau Server or Tableau Cloud, such as configuring server or site settings, running command line tools, and other tasks.

Authorization is managed within Tableau Server and Tableau Cloud. It is determined by a combination of the user's license level (Tableau Creator, Tableau Explorer, Tableau Viewer), site role, and permissions associated with specific entities such as workbooks and data sources. The project team should work together to define the permissions model. Tableau Server and/or Site Administrators or Tableau Cloud Site Administrator will assign permission rules to groups, and lock them to the project. Custom permissions allow more granularity in permissions—from accessing or downloading a data source to how a user interacts with published content.

Tableau's intuitive interface makes it easy to associate users to functional groups, assign permissions to the groups, and see who has access to which content. You can create groups locally on the server or import from Active Directory and synchronize on a set schedule. The permissions view also helps business users manage their own users and groups. For more information, see [Set-up Permissions Quick Start](#), [Configure Projects, Groups, and Permissions for Managed Self-Service](#), and [Permissions Reference](#).

Network Communication

Tableau Server

There are three main network interfaces in Tableau Server:

- Client to Tableau Server: The client can be a web browser, Tableau Mobile, Tableau Desktop, Tableau Prep Builder, or the tsm ([Windows](#) | [Linux](#)) and tabcmd ([Windows](#) | [Linux](#)) utilities.
- Tableau Server to your database(s): To refresh data extracts or handle live database connections, Tableau Server needs to communicate with your database(s).
- Server component communication: This applies to distributed deployments only.

You should configure SSL to ensure that access to Tableau Server is secure and that sensitive information passed between the server and Tableau clients is protected on your network. For more information, visit [Network Security](#) ([Windows](#) | [Linux](#)) and [Ports](#) ([Windows](#) | [Linux](#)). To review SSL configuration examples for industry standard reference architecture, visit Part 6 of the Tableau Server Enterprise Deployment Guide, [Part 6 - Post-Installation Configuration](#).

Secure On-Prem Servers

To prevent users with publish/explore permissions from connecting to Tableau Server resources that they shouldn't have access to, complete the following steps to configure and secure your on-prem servers.

1. Create a PostgreSQL user account.
2. Name it: `tbladminviews`
3. Select the least privileges for Admin Views.
4. Change the Admin Views workbook templates to use `tbladminviews` instead of `tblwgadmin`.
5. Add connection IP policy to deny private (non-routable) IP addresses:

- a. Change connection IP default rule to Allow

```
tsm configuration set -k ConnectionIPDefaultRule=ALLOW
```

- b. Deny private (not-routable) IP addresses

```
tsm configuration set -k ConnectionIPDenyRanges=127.0.0.1,192.168.0.0-192.168.255.255,172.16.0.0-172.31.255.255,10.0.0.0-10.255.255.255
```

Tableau Cloud

All communication with Tableau Cloud is encrypted using SSL for secure transmission of data. Clients include the following: a web browser, Tableau Desktop, Tableau Prep Builder, Tableau Bridge, Tableau Mobile, and [tabcmd utility](#). Tableau Cloud supports TLS 1.2 and higher. A variety of encryption techniques ensure security from browser to server tier to repository and back. In addition, Tableau has many built-in security mechanisms to help prevent spoofing, hijacking, and SQL injection attacks, and it actively tests and responds to new threats with monthly updates.

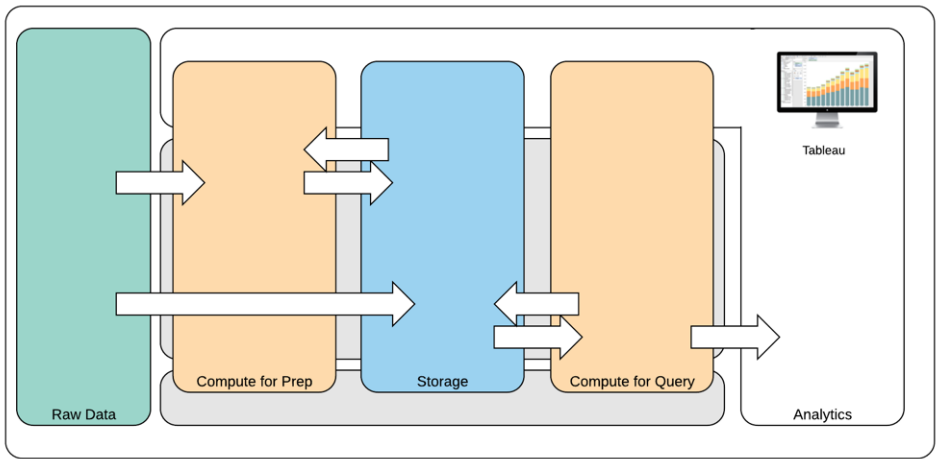
Network Topologies

Users will be accessing Tableau from all over the place: their offices, on the road from their phones, from client sites in another country, and more. To better understand common network configurations, visit the Tableau Server Enterprise Deployment Guide, [Part 3 - Preparing for Tableau Server Enterprise Deployment](#).

Data Strategy

Every organization has different requirements and solutions for its data infrastructure. Tableau respects an organization’s choice and integrates with your existing data strategy. In addition to the enterprise data warehouse, there are many new sources of data appearing inside and outside of your organization: cloud applications and data, big data databases, structured and unstructured Repositories. From Hadoop clusters to NoSQL databases, and many others, the data flow no longer needs to be centralized around the enterprise data warehouse (EDW) as a final destination.

Modern data architecture is driven by new business requirements (speed, agility, volume) and new technology. You choose whether to provide access to the data in place or enrich data with other sources. Combine this with cloud solutions that allow for infrastructure and services to spin up data pipelines in hours, and what you have is a process for moving data around an organization like never before. Unfortunately, the new opportunity is largely missed if your organization’s data management handbook was written using a traditional EDW’s single bucket of data mindset. The trick to shifting from buckets to pipelines is accepting that not all data questions within an organization can be answered from any one data source. The pattern for a modern data architecture is shown below.



Modern Data Architecture

1. Raw Data: sources of data, for example, transactional data that is loaded into the data platform that often needs transforming in several ways: cleansing, inspection for PII, etc.

2. **Compute for Prep:** the processing of the raw data can require significant computational resources, so it's more than traditional ETL. Often Data Science apps will sit here. They actually can create new data with high value.
3. **Storage:** Modern data platforms are built on a principle of storing data because you never know how it might be used in the future. Increasingly, we store intermediate data and multiple versions and forms of the same data. Storage is therefore layered.
4. **Compute for Query:** the typical analytic database engine, including Hyper extracts, but also Hadoop, etc.
5. **Analytics:** Tableau sits in Analytics.

Tableau's Hybrid Data Architecture

Tableau's hybrid data architecture provides two modes for interacting with data, using a live connection or an in-memory extract. Switching between the two is as easy as selecting the right option for your use case.

Live Connection

Tableau's data connectors leverage your existing data infrastructure by sending dynamic queries directly to the source database rather than importing all the data. This means that if you've invested in fast, analytics-optimized databases, you can gain the benefits of that investment by connecting live to your data. This leaves the detail data in the source system and sends the aggregate results of queries to Tableau. Additionally, this means that Tableau can effectively utilize unlimited amounts of data. In fact, Tableau is the front-end analytics client to many of the largest databases in the world. Tableau has optimized each connector to take advantage of the unique characteristics of each data source.

In-Memory Extract

If you have a data architecture built on transactional databases or want to reduce the workload of the core data infrastructure, Tableau's Data Engine powered by **Hyper technology** provides an in-memory data store that is optimized for analytics. You can connect and extract your data to bring it in-memory to perform queries in Tableau with one click. Using Tableau Data Extracts can greatly improve the user experience by reducing the time it takes to re-query the database. In turn, extracts free up the database server from redundant query traffic.

Extracts are a great solution for highly-active transactional systems that cannot afford the resources for frequent queries. The extract can be refreshed nightly and available to users during the day. Extracts can also be subsets of data based on a fixed number of records, a

percentage of total records, or filtered criteria. The Data Engine can even do incremental extracts that update existing extracts with new data. Extracts are not intended to replace your database, so right-size the extract to the analysis at hand.

If you need to share your workbooks with users who do not have direct access to the underlying data sources, you can leverage Extracts. Tableau's packaged workbooks (.twbx file type) contain all the analysis and data that was used for the workbook; making it both portable and shareable with other Tableau users.

If a user publishes a workbook using an extract, that extract is also published to the Tableau Server or Tableau Cloud. Future interaction with the workbook will use the extract instead of requesting live data. If enabled, the workbook can be set to request an automatic refresh of the extract on a schedule.

Query Federation

When related data is stored in tables across different databases or files, you can use a **cross-database join** to combine the tables. To create a cross-database join, you create a multi-connection Tableau data source by adding and then connecting to each of the different databases (including Excel and text files) before you join the tables. Cross-database joins can be used with live connections or in-memory extracts.

Data Server

Included with Tableau Server and Tableau Cloud, **Data Server** provides sharing and centralized management of extracts and shared proxy database connections, allowing for governed, measured, and managed data sources available to all users of Tableau Server or Tableau Cloud without duplicating extracts or data connections across workbooks.

Because multiple workbooks can connect to one data source, you can minimize the proliferation of embedded data sources and save on storage space and processing time. When someone downloads a workbook that connects to a Published Data Source that in turn has an extract connection, the extract stays in Tableau Server or Tableau Cloud, reducing network traffic. Finally, if a connection requires a database driver, you need to install and maintain the **driver** only on the Tableau Server, instead of on each user's computer. Similarly for Tableau Cloud, database drivers are managed by Tableau for supported sources of data.

Using the initial data use cases collected from each team, a DBA and/or Data Steward will publish a certified data source for each source of data identified for users with the appropriate permissions to access it. Users can connect directly to a Published Data Source from Tableau Desktop and Tableau Server or Tableau Cloud.

Published Data Sources prevent the proliferation of data silos and untrusted data for both extract and live connections. Extract refreshes can be scheduled, and users across the organization will stay up to date with the same shared data and definitions. A Published Data Source can be configured to connect directly to live data with a proxy database connection. This means your organization has a way to centrally manage data connections, join logic, meta data and calculated fields

At the same time, to enable self-service and flexibility, users can extend the data model by blending in new data or creating new calculations and allow the newly defined data model to be delivered to production in an agile manner. The centrally managed data will not change, but users retain flexibility.

Certified Data Sources

Database administrators and/or Data Stewards should certify Published Data Sources to indicate to users that the data is trusted. Certified data sources appear with a unique certification badge in both Tableau Server, Tableau Cloud, and Tableau Desktop. Certification notes allow you to describe why a particular data source can be trusted. These notes are accessible throughout Tableau when viewing this data source as well as who certified it. Certified data sources receive preferential treatment in search results and stand out in data source lists in Tableau Server, Tableau Cloud, and Tableau Desktop. Project leaders, Tableau Cloud Site Administrators, and Tableau Server/Site Administrators have permission to certify data sources. For more information, visit [Certified Data Sources](#).

Data Security

Data security is of utmost importance in every enterprise. Tableau allows customers to build upon their existing data security implementations. IT administrators have the flexibility to implement security within the database with database authentication, within Tableau with permissions, or a hybrid approach of both. Security will be enforced regardless of whether users are accessing the data from published views on the web, on mobile devices, or through Tableau Desktop and Tableau Prep Builder. Customers often favor the hybrid approach for its flexibility to handle different kinds of use cases. Start by establishing a data security classification to define the different types of data and levels of sensitivity that exist in your organization.

When leveraging database security, it is important to note that the method chosen for authentication to the database is key. This level of authentication is separate from the Tableau Server or Tableau Cloud authentication (i.e. when a user logs into Tableau Server or Tableau Cloud, he or she is not yet logging into the database). This means that Tableau Server and

Tableau Cloud users will also need to have credentials (their own username/password or service account username/password) to connect to the database for the database-level security to apply. To further protect your data, Tableau only needs read-access credentials to the database, which prevents publishers from accidentally changing the underlying data. Alternatively, in some cases, it is useful to give the database user permission to create temporary tables. This can have both performance and security advantages because the temporary data is stored in the database rather than in Tableau. For Tableau Cloud, you need to embed credentials to use automatic refreshes in the connection information for the data source. For Google and Salesforce.com data sources, you can embed credentials in the form of OAuth 2.0 access tokens.

Extract encryption at rest is a data security feature that allows you to encrypt .hyper extracts while they are stored on Tableau Server. Tableau Server administrators can enforce encryption of all extracts on their site or allow users to specify to encrypt all extracts associated with particular published workbooks or data sources. For more information, see [Extract Encryption at Rest](#).

If your organization is deploying Data Extract Encryption at Rest, then you may optionally configure Tableau Server to use AWS as the KMS for extract encryption. **To enable AWS KMS or Azure KMS, you must deploy Tableau Server in AWS or Azure, respectively, and be licensed for [Advanced Management for Tableau Server](#).** In the AWS scenario, Tableau Server uses the AWS KMS customer master key (CMK) to generate an [AWS data key](#). Tableau Server uses the AWS data key as the root master key for all encrypted extracts. In the Azure scenario, Tableau Server uses the Azure Key Vault to encrypt the root master key (RMK) for all encrypted extracts. However, even when configured for AWS KMS or Azure KMS integration, the native Java keystore and local KMS are still used for secure storage of secrets on Tableau Server. The AWS KMS or Azure KMS is only used to encrypt the root master key for encrypted extracts. For more information, see [Key Management System](#).

For Tableau Cloud, all data is encrypted at rest by default. Although with [Advanced Management for Tableau Cloud](#), you can take more control over key rotation and auditing by leveraging [Customer-Managed Encryption Keys](#). Customer-Managed Encryption Keys give you an extra level of security by allowing you to encrypt your site's data extracts with a customer managed site-specific key. The Salesforce Key Management System (KMS) instance stores the default site-specific encryption key for anyone who enables encryption on a site. The encryption process follows a key hierarchy. First, Tableau Cloud encrypts an extract. Next, Tableau Cloud KMS checks its key caches for a suitable data key. If a key isn't found, one is generated by the KMS GenerateDataKey API, using the permission granted by the key policy that's associated with the key. AWS KMS uses the CMK to generate a data key and returns a plaintext copy and encrypted copy to Tableau Cloud. Tableau Cloud uses the plaintext copy of the data key to encrypt the data and stores the encrypted copy of the key along with the encrypted data.

You can limit which users see what data by setting user filters on data sources in both Tableau Server and Tableau Cloud. This allows you to better control what data users see in a published view based on their Tableau Server login account. Using this technique, a regional manager is able to view data for her region but not the data for the other regional managers. With these data security approaches, you can publish a single view or dashboard in a way that provides secure, personalized data and analysis to a wide range of users on Tableau Cloud or Tableau Server. For more information, see [Data Security](#) and [Restrict Access at the Data Row Level](#). If row-level security is paramount to your analytics use case, with [Tableau Data Management](#), you can leverage virtual connections with data policies to implement user filtering at scale. For more information, see [Virtual Connections and Data Policies](#).

Move Tableau to the Cloud

From the beginning, Tableau has helped people see and understand data, no matter how they choose to do so. That philosophy extends to our customers' deployment strategy. You can host Tableau Server on-premises, host Tableau Server on a public cloud platform (AWS, Google Cloud Platform, Microsoft Azure, or Alibaba), or choose a fully-hosted offering, Tableau Cloud (formerly known as Tableau Online). You're not locked into that choice once you begin your data journey. If your organization changes its data strategy, Tableau adapts with you.

As cloud adoption has increased, many customers have elected to move Tableau to the cloud. This section outlines the benefits of migration, key factors to evaluate your ability to migrate, and guidelines and key resources to help you complete a migration. These considerations are different depending on whether you would like to move Tableau Server to a public cloud or if you would like to transition from Tableau Server to Tableau Cloud.

*Please note that this section is specifically created for customers who have an existing deployment and are considering changing their deployment method. New customers can skip past these considerations and learn more about [Tableau Platform Architecture](#) on page 118.

BEST PRACTICE RECOMMENDATION:

Platform migration provides a unique opportunity to optimize your environment. Many customers choose to take this time to evaluate these areas to ensure the best user experience:

- Removing Stale Content ([Tableau Server](#) | [Tableau Cloud](#))
- [Governance in Tableau](#) on page 81

- [Hardware Platform on page 120](#) and Tableau Server topology, if migrating Tableau Server to a Public Cloud
- [Addressing performance](#) issues

Considerations for Migrating from Tableau Server to Tableau Cloud

Many organizations are strategically moving to fully hosted Software-as-a-Service (SaaS) offerings to increase their agility and focus on analyzing data instead of managing infrastructure. Migrating your on-premises or public cloud version of Tableau Server to fully hosted Tableau Cloud can offer many benefits, including:

- Significant reduction in hardware and infrastructure complexity and cost
- Reduction in administrative overhead and expense
- Automatic software updates. Tableau Cloud is always running the latest version of Tableau.
- Consistent performance and scalability – no matter your user load or workbook complexity, Tableau Cloud automatically adapts and scales without any customer administrative requirements
- Positioned for the future of data analytics and visualization, which will be available immediately after it's released (Tableau GPT and Tableau Pulse being prime examples)

There are two general areas of consideration when contemplating a move from Tableau Server to Tableau Cloud:

- Should you migrate?
- If so, how do you migrate?

Before making your decision, [reach out to your Tableau account team](#). They will work with you to identify the best option for your organization and can assist with migration planning.

Should You Migrate from Tableau Server to Tableau Cloud?

The majority of Tableau customers will find that Tableau Cloud meets their needs. To help determine if migrating from Tableau Server to Tableau Cloud is not presently appropriate for your organization, consider the following:

- Information Security Compliance
- Data Source Type/Location
- User Authentication
- Custom Repository Views
- Tableau Licensing
- Tableau Server Deployment Complexity

Information Security Compliance

While Tableau Cloud conforms to [a large complement of standard Information Security standards](#), two specific areas of compliance are currently unsupported:

- Federal Risk and Authorization Management Program (FEDRAMP)
- Payment Card Industry (PCI)

If you're currently complying with these standards with your existing Tableau Server implementation, you're not presently a candidate for Tableau Cloud migration. Also, Tableau Cloud is presently hosted on Amazon Web Services. While Tableau is fully responsible for the staging, performance, and infrastructure that supports Tableau Cloud, some customers may have policies in place that prevent using Amazon-hosted products. In this case, you're not presently a candidate for Tableau Cloud migration.

Ask your Tableau account team to inform you when additional Tableau Cloud options are announced that mitigate these limitations.

Data Source Type/Location

Because Tableau Cloud is an entirely internet-based SaaS product, connecting to your data sources may require special consideration. Tableau Cloud can connect directly if you're accessing internet-based data sources (such as Snowflake or Databricks). Connecting Tableau Cloud to on-premise data sources (as you may have done with Tableau Server) must be accomplished securely across the internet, typically by installing the [Tableau Bridge](#) product within your network. While Tableau Cloud supports the vast majority of common data sources, there are a few limitations. As part of your evaluation for migration, consult [supported data sources and data source limitations](#) to ensure your data sources are compatible with Tableau Cloud. And, if you're extensively using server-based Tableau Prep Flows with on-premise data sources, you'll need to consider whether a migration will be feasible, as Tableau Bridge doesn't presently support Prep Flows. You may be able to make use of [this workaround](#), but should evaluate how much this may impact a possible migration to Tableau Cloud.

User Authentication

Users must individually authenticate on Tableau Cloud, just as Tableau Server users do (Tableau Cloud doesn't support a non-authenticated 'Guest' user). Because Tableau Server is hosted within a private network, [authentication options](#) may need to be modified when migrating. For example, if you're authenticating Tableau Server users via on-premises Microsoft Active Directory, you'll need to consider an alternative cloud-based authentication method, such as Azure AD via SAML.

Tableau Cloud Multi-Factor Authentication Requirement

Your data security is a very high Tableau priority. As such, [Multi-Factor Authentication \(MFA\)](#) is required with Tableau Cloud. Tableau with MFA authentication is an option if you won't be choosing an external [Single Sign-On identity provider](#) that supports MFA.

Custom Repository Views

Tableau Server provides the ability to design custom administrative visualizations via the PostgreSQL repository database connector. If you have used this feature, it will not be directly compatible with Tableau Cloud, as the Tableau Cloud repository database is not directly accessible.

Tableau Cloud's alternative is [Admin Insights](#), a Tableau Cloud-only project that is pre-populated with [carefully curated data sources](#) and a pre-built workbook of your site's data. Just like the repository of Tableau Server, you can create custom workbooks with this data to better [measure your Tableau user engagement and adoption](#).

With Advanced Management, you'll also have access to [Activity Log](#), which provides details on specific events that happen in your site. You'll have greater insight on what happens in Tableau Cloud to understand things like Permission-related changes to ensure access is properly granted on your site.

Tableau Licensing

If you've been using Tableau Server for some time, you may be using legacy licensing and pricing models, such as CPU core licensing and Guest user access. Tableau Cloud, however, only uses Role-Based Subscription licensing. If you're on a previous licensing model, please contact your Tableau account team to convert your licensing to a Role-Based Subscription. For more information, see [Tableau License Management](#).

External analytics deployments can also leverage our [usage based licensing model](#) to scale insights outside your organization in a more scalable, agile and cost-effective way.

Complex Tableau Server Environment

If you have utilized Tableau Server's extensibility and expandability capabilities to support a complex environment (for example, many server sites, a complex project/content/permission model, a large number of Tableau Server nodes, or extensive embedding of Tableau Server content into other applications), discuss the applicability of Tableau Cloud with your Tableau account team. You may find that the benefits of a fully-hosted Tableau Cloud environment provide the scale and performance you've come to expect without the complexity required to maintain your existing infrastructure. Or, you may discover that you will be best suited to maintain your current Tableau Server environment. Your account team may recommend that you engage [Tableau Professional Services](#) to conduct a thorough evaluation of your environment and recommend the best approach to migrating to Tableau Cloud.

How Do You Migrate from Tableau Server to Tableau Cloud?

After evaluating the presented considerations, you've decided to migrate from Tableau Server to Tableau Cloud. Great! But how do you migrate? Generally, depending on the size and complexity of your Tableau Server environment, there are two directions available for migration:

- Self-migrate to Tableau Cloud
- Engage Tableau Professional Services or a Migration Partner

Self-Migrate to Tableau Cloud

The size and complexity of your Tableau Server environment will determine if self-migration is a viable option for you. Each Tableau Server installation is unique, and you'll ultimately need to determine if a self-migration is appropriate (your Tableau account team can help you decide).

Self-migration may be appropriate if:

- Your Tableau Server supports no more than 100 - 150 users
- You have a simple project/permissions structure (generally speaking, no more than 20 - 25 projects/nested projects and simple permissions with a small number of user groups)
- Your data sources are easily accessible by Tableau Cloud (either directly or via Tableau Bridge)
- You maintain a relatively small amount of content (generally, no more than 50 workbooks, data sources, and other content items)

- You aren't using multiple sites
- You have an available technical resource comfortable with the migration process

If this doesn't sound like your Tableau Server deployment, we recommend skipping down to "Engage Tableau Professional Services or a Migration Partner."

Because migrating from Tableau Server to Tableau Cloud isn't as simple as creating a Tableau Server backup file and restoring it to another server, you'll need to start with a good understanding of the migration process. The first step is determining what content to migrate. The best starting place: [identifying stale content](#). If you're not using workbooks or data sources, you probably won't need to migrate them.

The [Tableau Cloud Manual Migration Guide](#) is your roadmap to self-migration. Specifically designed to guide you step-by-step through the process, you'll want to consult this document as soon as you consider self-migration. You'll immediately know the scope and effort required to migrate your particular Tableau Server environment. This guide breaks down the migration process into a logical, organized process:

- Plan Your Migration
- Create and Configure a Tableau Cloud Site
- Migrate Data Sources and Workbooks to Tableau Cloud
- Recreate Refresh Schedules for Tableau Cloud
- Configure Permission and Content Access for Migrated Users
- Add Remaining Users to Tableau Cloud
- End-User Migration Checklist

The most appropriate people you'll designate to self-migrate will probably be those most familiar with your existing Tableau Server environment, perhaps a Tableau Server administrator or a third-party consultant you originally engaged to install and maintain your Tableau Server environment. They should consult the Manual Migration Guide and plan the migration process accordingly.

Engage Tableau Professional Services or a Migration Partner

We strongly recommend engaging [Tableau Professional Services](#) or one of our [experienced partners](#) for more complex Tableau Server environments, or if you don't have ready access to appropriate technical resources.

Because this is a one-time effort that benefits from specialized knowledge, most customers with more complex deployments opt to maximize time-to-value by utilizing Tableau's experts and our trusted partners. Our experience in the process has helped customers migrate confidently in a more clearly defined timeframe. Your Tableau account team can provide you with details on Tableau Professional Services options or refer you to a trusted Migration Partner.

Considerations for Migrating Tableau Server to a public cloud

Tableau Server was originally intended as, and is often referred to, as an on-premises product, originally intended to be installed within your own network behind your corporate firewall. But the advent of cloud computing gives Tableau Server customers additional options. As opposed to the Software-as-a-Service (SaaS) model of Tableau Cloud, there is the Infrastructure-as-a-Service (IaaS, or often referred to as public cloud) model (arguably pioneered by Amazon Web Services). This hybrid model, sitting between traditional on-premises and fully hosted SaaS options, provides the ability to offload on-premises hardware and infrastructure requirements, while maintaining the complete flexibility and customizability you've come to expect from your on-premises Tableau Server.

If you are considering migrating your on-premises Tableau Server to a [supported public cloud](#), this section is for you. If you are a new customer just starting your Tableau journey and don't presently have Tableau Server running in your own environment, consult [Tableau Platform Architecture](#) and [Tableau Cloud](#) as you consider a destination for your new Tableau environment.

If you are planning to migrate Tableau Server from an on-premises deployment to a deployment hosted in a public cloud, you will need to consider five areas:

- The migration process
- Architecture
- Networking
- Data connectivity
- Tableau licensing

Because considerations and services differ depending on the public cloud provider, general language is used to describe these services and processes. Refer to your provider's documentation for information on how best to manage their services.

Your Tableau account team is ready to help you with your migration. They may recommend that you engage [Tableau Professional Services](#) to conduct a thorough evaluation of your environment and recommend the best approach to migrating to your public cloud provider.

Migration Process

Migrating content is a relatively standard process. There are two primary routes. [The most straightforward approach](#) involves backing up your existing Tableau Server environment, installing Tableau Server in the new location, and then restoring the backup file.

However, as part of the migration process, you may consider [identifying content that is no longer being actively used](#) on your existing server. You may then manually migrate only desired content to your new environment. This is most commonly used for smaller deployments which have fewer assets or if there are significant administrative changes being made in tandem (like changing the Identity Store). If you have acquired [Tableau Advanced Management](#), the [Content Migration Tool](#) can significantly speed up your ability to migrate selected assets to the new environment.

Enterprises migrating their analytics applications and data infrastructure to AWS require expertise, resources, and alignment of business and IT strategy. Many organizations can accelerate their migration and time to value through working with a consulting partner validated by both Tableau and AWS. To learn more about this specialized offering, see [Modern Cloud Analytics](#).

Architecture

While you'll no longer be responsible for installing and maintaining physical or virtual machines in your own network to run Tableau Server, you'll still need to specify and configure [adequate virtual machine \(VM\) resources](#) with your specific cloud provider. As you did when you initially installed Tableau Server in your own environment, you'll want to consider [initial sizing](#) for your public cloud environment.

As public cloud environments are entirely virtualized, one of their primary benefits is flexibility to add additional capacity as you find the need. For example, you may easily duplicate your initial configuration to facilitate creation of separate [production and test environments](#). And, public cloud environments provide the perfect flexibility for [scaling Tableau Server](#) up (expanding processor, memory, or disk capacity for a single VM) or out (adding additional VM nodes). With no more concerns about hardware or infrastructure requirements in your own network, you may easily modify existing VMs or "spin up" new ones, facilitating your desired [High Availability](#) and [Disaster Recovery](#) scenarios.

Networking

Considering that your Tableau Server will no longer be behind your corporate firewall, connection consideration for both data source access and user access will be critical. As you plan, you will need to balance both security and accessibility. Cloud providers have a robust set of services to enable secure and flexible communication, as evidenced by this [Amazon Web Services example](#).

While specific services are different for each cloud provider, your networking considerations do not change. There are the three primary routes of communication you will need to enable as you establish your networking rules.

1. Tableau Server will need to be able to connect to data sources.
2. Creators will need to be able to access both Tableau Server and necessary data sources (whether the data sources are on-premises or cloud-hosted).
3. Your data community will need access to Tableau Server.

The path you take to achieve this will vary, depending on your choice of cloud provider and your organization's network infrastructure. Regardless, you'll need to accommodate each of these requirements to successfully migrate Tableau Server to the public cloud.

Data Connectivity

While overall networking considerations discussed previously are important, perhaps the most critical consideration you'll need to make early in your migration planning is data connectivity. Depending on where critical data sources are located, connecting your public cloud-based Tableau Server to them may be straightforward, or may involve more complex requirements.

If your data sources are also being moved to the same public cloud provider, modifying Tableau Server data connection names or IP addresses may be all that is required. However, your data sources may still be located within your existing network, behind your corporate firewall. In this case, you'll need to leverage vendor-specific services to create secure pathways to your data, have your networking team make firewall modifications to allow Tableau Server access, or migrate the data itself to a cloud-based data provider (such as Databricks or Snowflake).

Tableau Licensing

Whether you choose to deploy Tableau Server on-premises or in the cloud, there are no licensing implications. You may even use the same license keys when you migrate to the new environment.

More Resources

For more helpful information on migrating Tableau deployments to Tableau Cloud, check out these resources:

- [Webinar: A Blueprint Approach to Implementing Tableau Cloud with CrowdStrike](#)
- [Tableau Cloud Migration Homepage](#)
- Detailed Technical Considerations for Migrating from Tableau Server to Tableau Cloud [Server on Windows](#) | [Server on Linux](#)
- [Tableau Cloud Migration Readiness Assessment](#): This is an accelerator (a premade Tableau workbook) available for free through the Tableau Exchange. The Tableau Cloud Migration Readiness Assessment quickly examines the way you're using Tableau Server (23.1+) to understand if there are any use cases which may need to be adapted before migrating to Tableau Cloud. In just a few minutes, the assessment provides a data-driven approach to understand your technical readiness for a Tableau Cloud migration.

Tableau Data Management

[Tableau Data Management](#) helps you better manage the data within your analytics environment, ensuring that trusted and up-to-date data is always used to drive decisions. From data preparation to cataloging, search, and governance, Tableau Data Management will increase trust in your data, accelerating the adoption of self-service analytics. The offering is a separately [licensed](#) collection of features and functionality including Tableau Prep Conductor and Tableau Catalog, which manage Tableau content and data assets in Tableau Server and Tableau Cloud.

What is Tableau Data Management?

Overall, your organization will benefit from [data governance](#) and [data source management](#) approaches discussed elsewhere in Tableau Blueprint. Beyond these methodologies, you will often hear generic references to the term Data Management in the database, data analytics, and visualization communities. However, this term gets more specific when it comes to Tableau with [Tableau Data Management](#), a paid add-on set of features for use with Tableau Server and Tableau Cloud. Regardless of whether you're using Tableau Server for [Windows](#) or [Linux](#), or

Tableau Cloud, the features of Tableau Data Management are mostly identical (a small subset of features may only be available in Tableau Cloud or in Tableau Server).

Tableau Data Management encompasses a set of tools that help your organization's data stewards and analysts manage data-related content and assets in your Tableau environment. Specifically, three additional feature sets are added when you purchase Tableau Data Management:

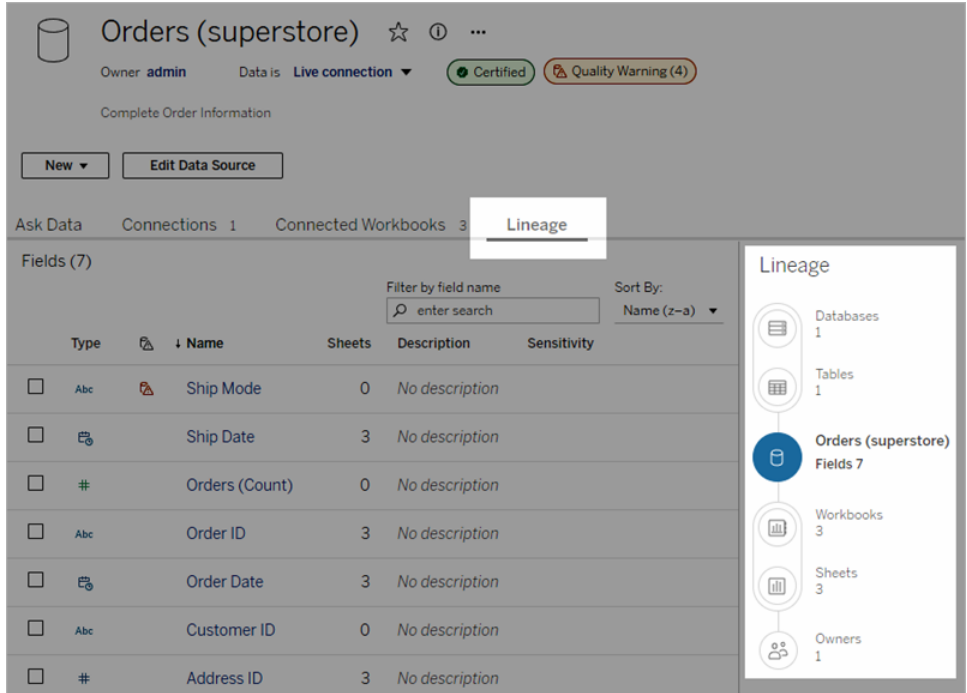
- Tableau Catalog
- Tableau Prep Conductor
- Virtual Connections with Data Policies

Tableau Catalog

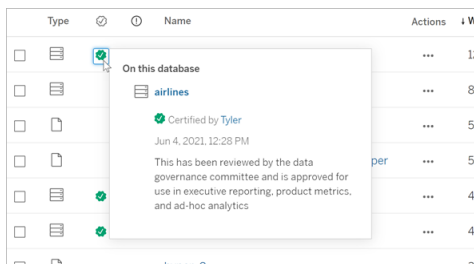
The original feature of Tableau Data Management, **Tableau Catalog** provides features to help streamline access, understanding, and trust of Tableau data sources. Focusing on areas such as lineage, data quality, search, and impact analysis, Tableau Catalog can make it easier for data stewards and data visualizers/analysts to understand and trust data sources in Tableau Server and Cloud. Tableau Catalog includes additional features for Tableau developers via **metadata methods** in the Tableau REST API.

When Tableau Catalog is initially enabled, it scans all related content items in your Tableau Server or Cloud site to build a connected view of all related objects (Tableau Catalog refers to this as content metadata). This expands search capabilities beyond just data connections. Data stewards and visual authors may search based on columns, databases, and tables as well.

To reduce the possibility of inadvertently modifying or deleting an object that another object depends on (for example, renaming or removing a database column that is key to a production workbook) **Tableau Catalog's lineage feature** exposes interrelationships among all content on a Tableau site including metrics, flows, virtual connections. You may now easily see the relationships amongst objects and analyze the impact of a pending change before you make it.



To improve trust in your Tableau data sources, Tableau Catalog provides supplementary information, such as expanded data-related object **descriptions**, the **Data Details** view, and keyword **tags** for enhanced searching flexibility. **Certifying data sources** places a prominent icon next to data sources to signify a data source owner or administrator’s trust of the data source. Data items (data sources, columns, and so forth) that may be cause of concern to consumers, such as deprecated or stale data, may be designated with **data quality warnings**. In addition to a data quality warning option, sensitive data may be specifically flagged with **Sensitivity Labels**.



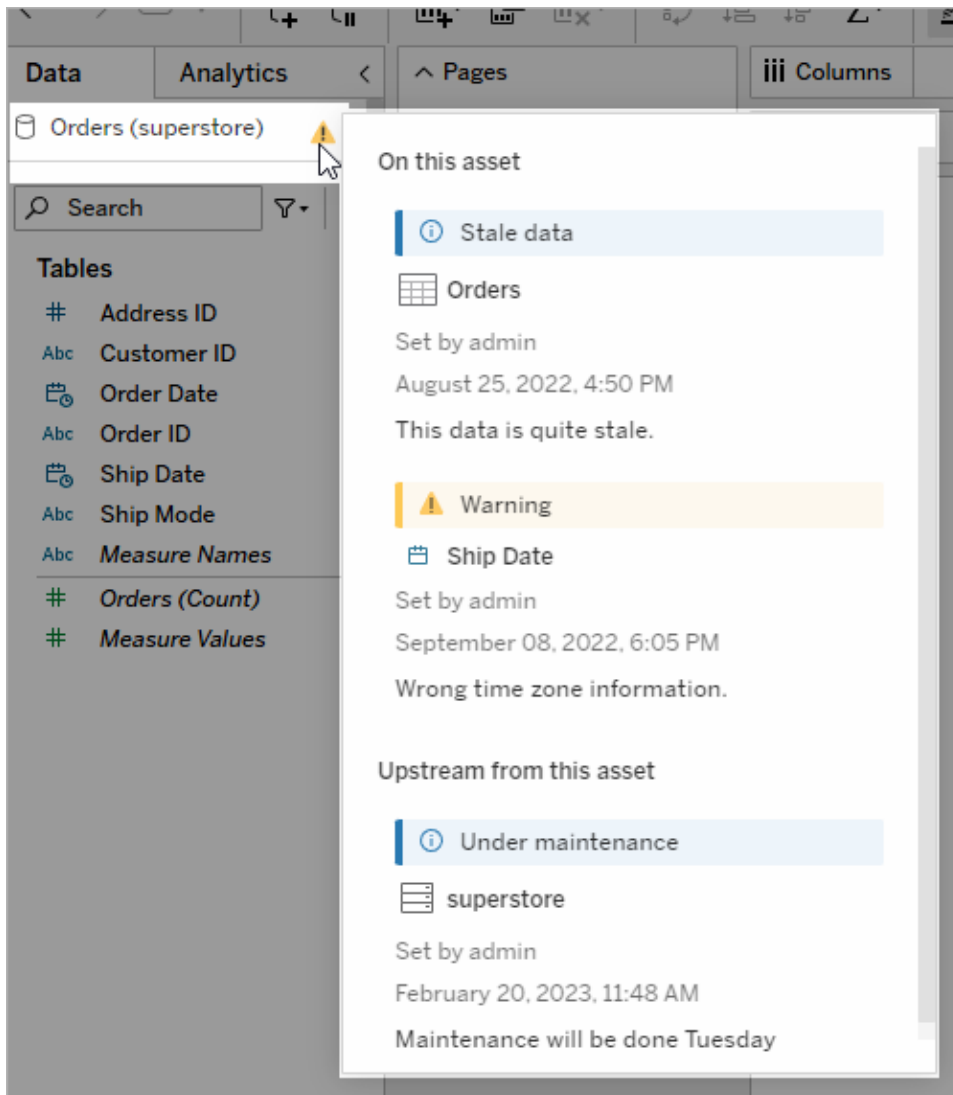


Tableau Prep Conductor

If you're like many Tableau customers, you've discovered the benefits of [Tableau Prep Builder](#) to create sophisticated data preparation “flows” that combine multiple data sources, shape data, customize columns, and output to one or more desired data formats. But once you create the perfect Prep flow, how do you automate it to run and fully or incrementally update data sources on a schedule?

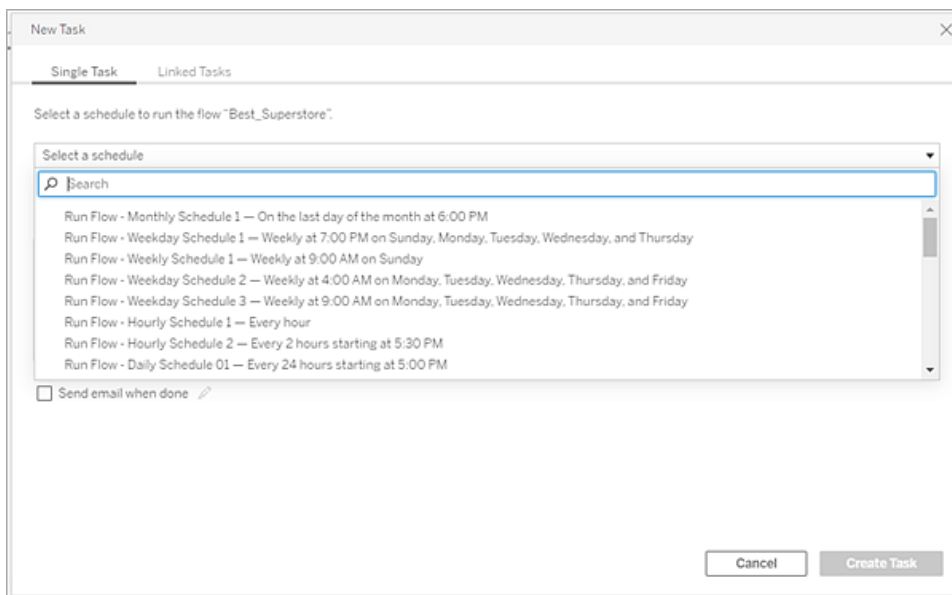
This is where [Tableau Prep Conductor](#), another feature of Data Management, comes into play. Tableau Prep Conductor allows flexible scheduling of Tableau Prep Flows, regardless of

whether they are published to your Tableau Server or Tableau Cloud environment from Tableau Prep Builder or created directly in a browser with [Prep Flow Web Authoring](#). Begin by testing your web-based flow (you may run flows manually on-demand without Data Management, but will need to purchase Data Management to schedule flows to run automatically with Prep Conductor). The flow should run to completion and create your desired output data source without errors before you schedule.

If you are using Tableau Server, your administrator (or you, if you have proper privileges) can create custom schedules (such as “Daily at midnight,” “Sunday at noon,” and so forth) to run prep flows, much as you may have done for extract refreshes.

If you are using Tableau Cloud, a set of predefined prep flow schedules are installed by default. You cannot customize these or create your own prep flow schedules.

Schedule flows to run from the Actions menu. A [Single Task](#) schedule will run only the selected prep flow on the schedule you select. A [Linked Task](#) schedule will permit you to select one or more additional flows to run in sequence with the selected flow, should you wish to “chain” multiple flows to run in a specific order (perhaps to create one data source output to be used as an input data source for a subsequent flow). The flows will now run when scheduled, automatically updating or creating data sources that Tableau Workbooks may be based on.



In addition to the ability to schedule flows, Data Management and Tableau Prep Conductor add options to [monitor](#) scheduled flow successes/failures, [send email notifications](#) when flow schedules succeed or fail, programmatically run flows with the Tableau Server/Cloud [REST API](#), and benefit from [additional Administrative View capabilities](#) to monitor flow performance history.

BEST PRACTICE RECOMMENDATION: If you are planning on running a large number of Tableau Prep Conductor flows on Tableau Server, you may need to adjust scaling of your server environment. If necessary, [tune performance](#) of your Tableau Server system by adding additional nodes or background processes to accommodate required prep flow load.

What about Tableau Cloud? While you won't be required to consider architectural changes to Tableau Cloud for prep flow capacity, you are required to acquire one [Resource Block](#) (a unit of Tableau Cloud computing capacity) for each concurrent Tableau Prep Conductor flow you wish to schedule. Determine how many concurrent flow schedules you require and purchase Tableau Cloud resource blocks accordingly.

Virtual Connections

Onto our next Data Management feature - [Virtual Connections](#). A virtual connection provides a central access point to data. It can access multiple tables across several databases. Virtual connections let you manage extracting the data and the security in one place, at the connection level.

When are virtual connections useful?

If you consider a traditional way of sharing a database connection with multiple workbooks in Tableau, you'll probably think of connecting directly to a database server like SQL Server or Snowflake, supplying database login credentials, adding and joining one or more tables, and then publishing the data source to Tableau Server or Tableau Cloud. While you may choose to use this as a live connection to data, it's very possible you want to extract data from the data source to speed up connected workbooks.

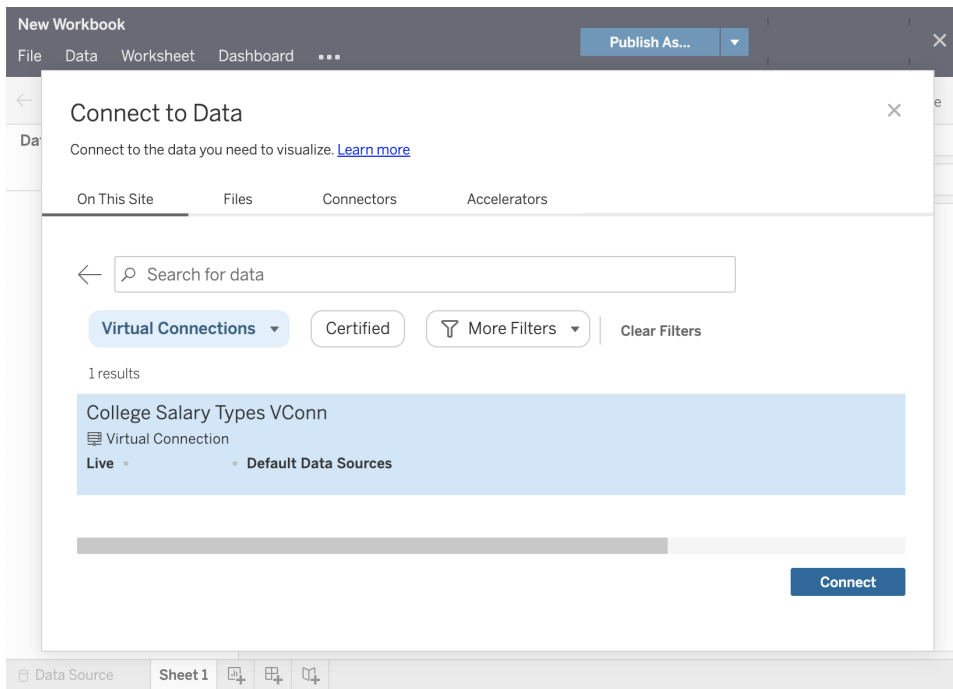
For the sake of discussion, let's consider that you may do this any number of times to accommodate, for example, a different set of tables or joins, resulting in multiple published (and, perhaps, extracted) data sources used for a series of workbooks that have different table/join requirements, but that all use the same initial database.

Now, let's consider what happens if something about the initial SQL Server or Snowflake database that's referenced in that series of data sources changes—perhaps tables are renamed, additional fields are added, or database credentials are changed. You are now faced with the task of opening each of the previously-created data sources, making necessary changes to accommodate the database change, and republishing (and, perhaps, rescheduling extract refreshes).

You might find it far simpler to create only one initial data connection “definition” which stores database server name, credentials, and table references. And, you might prefer to extract data from that larger “definition.” Then, when you need to create different data sources for various combinations of tables, joins, and so forth, you may reference that initial “definition” rather than connecting directly to one or more database servers. If something in the core database structure changes (for example, table names change or credentials are modified), you only need modify the initial “definition” object and all the dependent data sources automatically inherit the changes.

The Data Management feature introduces this shared “definition” capability via a virtual connection. A virtual connection is similar to a standard data source connection in that it stores the database server, login credentials, and selected tables. And, like a traditional Tableau data source, a virtual connection can contain connections to more than one database/data source (each with its own set of credentials and tables). While some metadata modifications are allowed in a virtual connection (for example, hiding or renaming fields), tables are not joined within the virtual connection. When you eventually use the virtual connection as a direct source for a workbook or as a connection type for an additional published data source, you may join tables and perform further customizations to the data source.

Once a virtual connection has been created and published to Tableau Server or Tableau Cloud and proper permissions have been set, you may connect to the virtual connection in Tableau Desktop or Tableau Server/Cloud just like you would any other data source. However, you won’t need to specify a database server location or supply credentials, and you’ll immediately be able to join tables and proceed to visualize data or publish the data source.



Data Policies

In addition to the centralized database connection features described earlier, Tableau Data Management virtual connections also provide a more streamlined centralized Row Level Security option with **Data Policies**. Use a data policy to apply row-level security to one or more tables in a virtual connection. A data policy filters the data, ensuring that users see only the data they're supposed to see. Data policies apply to both live and extract connections.

When are data policies useful?

It's common in many organizations to automatically restrict data visible in a visualization to only what is applicable to the current user. For example, consider a shared dashboard that contains order details in a cross tab object.

- If you are a Sales Manager for a large territory, the details cross tab will show orders for every account executive in your territory.
- However, if you're an individual account executive, the details cross tab will only show orders for your accounts.

This scenario requires that **Row Level Security** be implemented in your Tableau environment, which can be accomplished with one of several methods, including:

- **Row level security in the database.** Every time a visualization is viewed, the viewer is prompted to log into the underlying database with their own credentials or their credentials are inherited from their Tableau user account. The resulting data set is restricted to only data they are permitted to see based on the credentials supplied. Not only can this rapidly become tedious with each viewer being required to maintain their own credentials, but the live data connection may impact performance by placing a large burden on the underlying database. Furthermore, some options for passing on credentials to live connections may be restricted with Tableau Cloud.
- **Tableau User Filters.** User filters are applied when creating individual worksheets within a workbook. By specifying combinations of either individual Tableau user credentials, or membership in one or more Tableau user groups, individual worksheets can be filtered to only show data relevant to that user. This may become tedious, as each individual worksheet within a workbook requires user filters to be supplied – there is no way of specifying a user filter over a large group of workbooks with one process. Additionally, if a user is inadvertently given edit permissions to the workbook, they may easily drag the user filter off the filter shelf and see all underlying data that they may not have permission to view.

By making use of a subset of the Tableau calculation language, data policies can specify sophisticated rules (perhaps by use of a related “entitlement table” in a database) to customize and limit data that the virtual connection returns, based on user ID or group membership. Not only does this maintain Row Level Security at the data source level (all workbooks connected to the data source will automatically inherit the security and adopt any changes made within the virtual connection), it adds an additional layer of security by restricting any modification of data policies to only those with edit permissions for the original virtual connection.

Tableau Advanced Management

As a Tableau deployment grows across an organization and serves more users and use cases, Tableau transitions from an application that is used in small workgroup scenarios, to a business-critical enterprise platform that is managed and governed by IT. Additional controls, security, and governance measures must be implemented to support the platform as an enterprise-wide service.

Tableau Advanced Management brings together manageability, security, and scalability capabilities for customers running Tableau in mission-critical use cases. Advanced Management's highly configurable capabilities make it easier to understand your Tableau ecosystem and meet tough security requirements while delivering an improved end-user experience. This leads to increased agility and significant time savings for IT.

Advanced Management is available for both Tableau Server and Tableau Cloud and is licensed separately from your Tableau Server or Tableau Cloud deployment.

Click into the following sections to learn more about Advanced Management for Tableau Server or Tableau Cloud based on your deployment.

Advanced Management for Tableau Server

[Advanced Management for Tableau Server](#) is separately licensed for Tableau Server or bundled with Data Management as part of the Enterprise Subscription Plan, providing enhanced security, manageability, and scalability capabilities. The offering brings together additional cluster configuration options, agent-based cluster monitoring, and content migration capabilities to meet specific deployment and workflow requirements.

Configuration Management

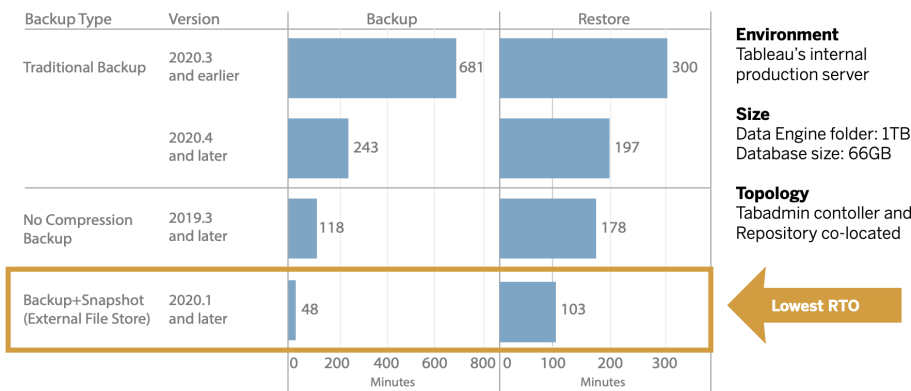
Advanced Management for Tableau Server delivers deeper integration with AWS, Azure, GCP, and on-premises deployment types, allowing you to further leverage your technology investments and expertise. The table below shows the capability and corresponding cloud service or on-prem infrastructure.

	AWS	Azure	GCP	On-premises
External File Store	Amazon EFS or FSx	Azure File Store	Google Filestore	NAS
External Repository	Amazon RDS for PostgreSQL	Azure Database for PostgreSQL	Cloud SQL for PostgreSQL	PostgreSQL database
Key Management	AWS KMS	Azure Key Vault	-	-
Independent Gateway	AWS EC2	Azure VM	Google Compute Engine	Additional node

AWS Azure GCP On-premises

VM

External File Store streamlines your deployment topology by centralizing the File Store on your enterprise-class storage system, eliminating the need to run local File Stores on multiple nodes in a Tableau Server cluster, and reducing network traffic during replication across nodes. If you are experiencing disk space constraints or high network traffic from node-to-node replication, you should consider implementing External File Store. For more information, see [Tableau Server External File Store](#).



External Repository provides increased scalability and high availability for organizations with large amounts of Tableau metadata by separating the PostgreSQL database from the default, local PostgreSQL database installation so that you can manage it outside of Tableau with your other database maintenance processes. AWS and Azure configurations offer enhanced scalability, reliability, high availability and security leveraging the speed and scale of the cloud. For on-premises deployments, you can manage it using a self-managed PostgreSQL instance. For more information, see [Tableau Server External Repository](#).

With Key Management, you can centralize your key management efforts and unlock more advanced security and compliance scenarios. The provides enhanced security by removing the master encryption key from the Tableau Server file system and storing it in the AWS or Azure platforms' secure key management solution. For more information, see [Key Management System](#).

Disaster Recovery

Utilizing external storage enables administrators to take snapshot backups of Tableau data if the storage device supports hardware snapshotting. This significantly reduces the time it takes to do

a Tableau backup and restore. The result is a lower Recovery Time Objective (RTO) for disaster recovery.

Because backup is also a recommended part of the upgrade process, you will also achieve faster upgrades. Using one illustrative data point, Tableau's internal Tableau Server deployment with a 1TB Data Engine folder and 66GB Repository completed a backup in less than 20% of the time it took with the default configuration, enabling an entire upgrade to be completed in less than 4 hours. For more information, see [Backup and Restore with File Store](#).

Workload Management

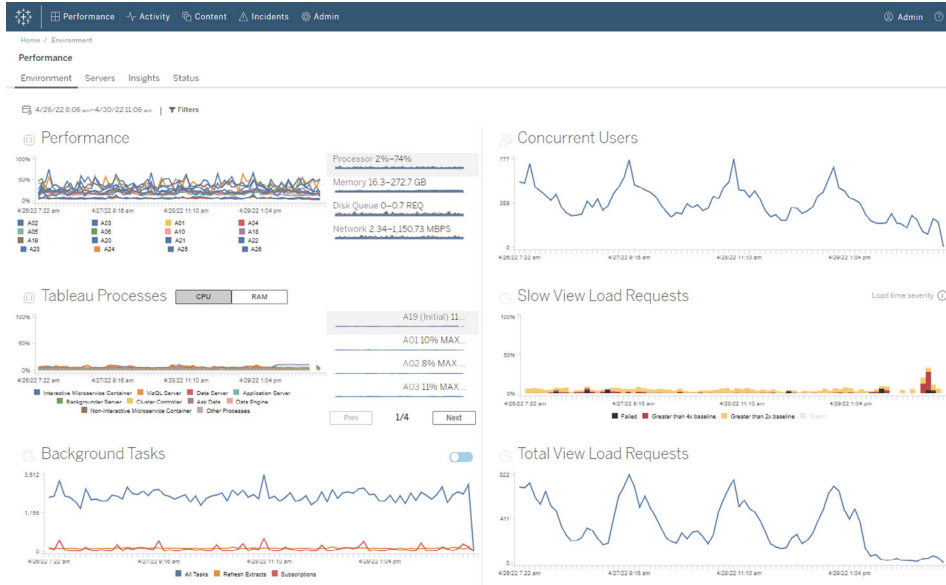
When your background jobs increase as the number of extract refreshes and subscriptions grow, you may see job queueing. As a result, your users may not have access to the most current data, and they could experience delayed subscription delivery. Tableau Advanced Management enables you to configure node roles so that you can optimize backgrounder workload management by dedicating specific cluster resources to each type of job.

Backgrounder node roles for extract refreshes, subscriptions, and any combination related to extract refreshes and subscriptions alongside flow-only nodes with [Tableau Data Management on page 149](#) for flow execution provide greater control over workloads. By isolating these workloads to specific nodes, it's easier to scale your deployment to the needs of your organization. For more information, see [Workload Management through Node Roles](#).

Monitoring & Chargebacks

As more users are on-boarded and the use of analytics grows across your organization, Tableau becomes mission-critical for data-driven decisions. Without monitoring, a “set-it-and-forget-it” deployment can be met with inadequate resources that fail to support the workload of highly-engaged users. Ongoing, proactive monitoring is required to operate and support your deployment at scale and meet the expectations of your user community.

[Resource Monitoring Tool](#) is an agent-based monitoring solution that offers deep insights into the health and performance of a Tableau Server cluster by parsing and analyzing the logs generated by system usage and combining that with monitoring of physical system usage (CPU Usage, RAM, Disk I/O etc.). As an administrator, you can define threshold alerts from environment, performance, and workload data that is aggregated from all your Tableau Server environments, as well as trace activity down to the user or session-level to isolate issues faster. With increased visibility into hardware utilization, VizQL sessions, data source queries, backgrounder workloads and more, it's easier to manage the health of your Tableau Server deployment and precisely tune the performance of your server.



To manage and distribute analytics costs on your shared-infrastructure Tableau deployment within your organization, RMT includes chargeback modeling, which is especially useful if analytics is not handled through centralized accounting under one cost center. Chargeback reports show usage on a per-site or per-project basis.

The report is generated as a Tableau workbook, allowing you to modify the report or reuse the data as needed. The chargeback workbook shows a breakdown of various metrics based on site and/or project. This allows you to customize total cost to chargeback, adjust chargeback weight for each metric, and generate an invoice-style formatted view.

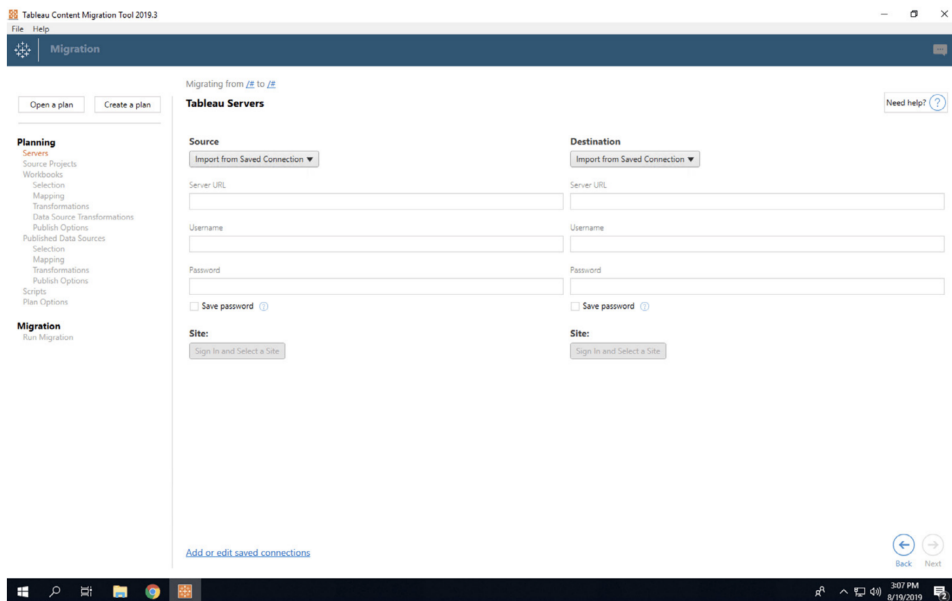
Content Management

Content Management on page 98, which is part of your **Content Governance in Tableau on page 97** practices, is key to enabling the effective use of data and analytics. Without content management, users will find it increasingly difficult to find what they need among irrelevant, stale, or duplicate workbooks and data sources. The Content Migration Tool automates tasks such as content promotion and archiving, supporting both traditional and modern workflows or anywhere in between.

With a codeless, streamlined, and repeatable migration plan, you can copy or migrate content between projects on a single Tableau Server installation, or if you have user-based licensing, between projects on separate Tableau Server installations (for example, from a development instance of Tableau Server to a production instance).

The Content Migration Tool User Interface walks you through the steps necessary to build a migration plan that you can use a single time or schedule for repeated migrations. In addition, you

can remap data sources and perform other workbook transformations. For more information, see [Content Migration Tool](#) and [Content Migration Tool Use Cases](#).



Advanced Management for Tableau Cloud

[Advanced Management for Tableau Cloud](#) makes it easy to quickly manage, secure, and scale mission-critical analytics, saving administrators time. Advanced Management is separately licensed for Tableau Cloud, delivering manageability, security, and scalability capabilities. Advanced Management helps you:

- **Understand your environment.** Keep your finger on the pulse of your Tableau deployment with operational insight features.
- **Manage content at scale.** Seamlessly promote content for your robust content lifecycle management needs.
- **Enhance security.** Meet organizational security requirements with more control over your data encryption keys.
- **Scale for your enterprise.** Leverage increased site capacity in Tableau Cloud to ensure users have access to the data they need to make data-backed decisions

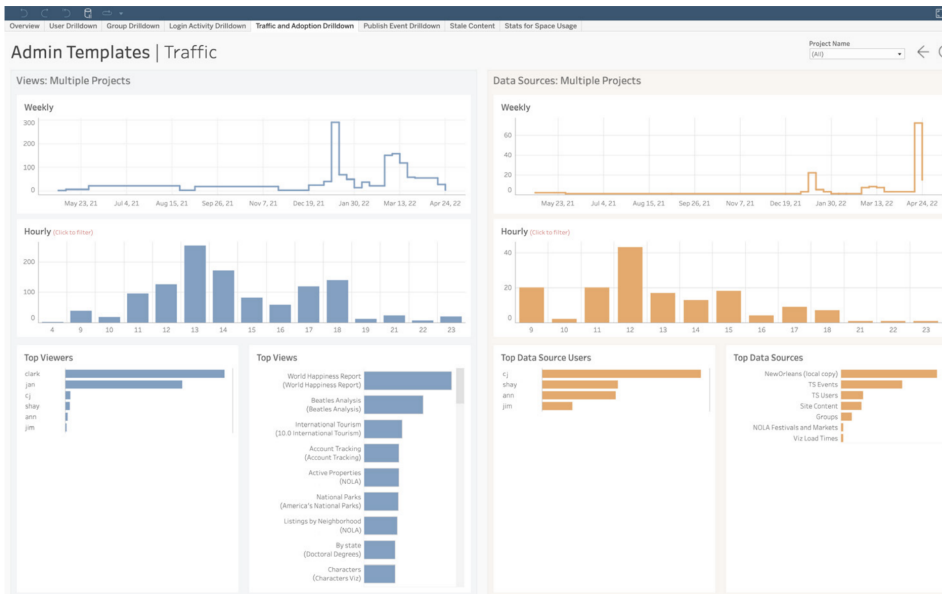
Understand your environment

As more people use Tableau, it becomes a business-critical application for your organization. Users expect an easy to navigate, governed, and curated experience. When administrators take a passive, nonchalant approach to their deployment, they often fail to properly meet expectations resulting in poor adoption—and fewer data-driven decisions. Proactive, in-depth monitoring is required to manage your Tableau Cloud deployment at scale and keep your users engaged.

Fortunately, Advanced Management for Tableau Cloud improves and simplifies monitoring efforts, allowing you to track user actions and adoption over time. With the Activity Log and up to 365 days of data in Admin Insights, you can easily manage your Tableau Cloud ecosystem.

The Activity Log goes above and beyond existing monitoring data by providing detailed event data to help administrators track how individuals are using Tableau. Once the Activity Log is configured, you will receive a JSON file in an AWS S3 bucket every hour allowing you to integrate Tableau Cloud usage data with your security information and event management solution. You can use the Activity Log to conduct permissions auditing, verifying that users have access to appropriate content.

Admin Insights is a Tableau Cloud project that comes with a prebuilt Admin Insights Starter workbook and curated data sources. With Advanced Management, Admin Insights retains data for up to 365 days allowing you to better track site adoption, viz performance, and publishing-related activity over time.



Whether you choose to leverage the prebuilt content or build custom admin views, more data allows you to easily answer historical questions like:

- **Who is building the most Tableau content?**
- **Who hasn't logged in the last 100 days?**
- **What are the most used views and data sources?**
- **What content isn't being used anymore?**

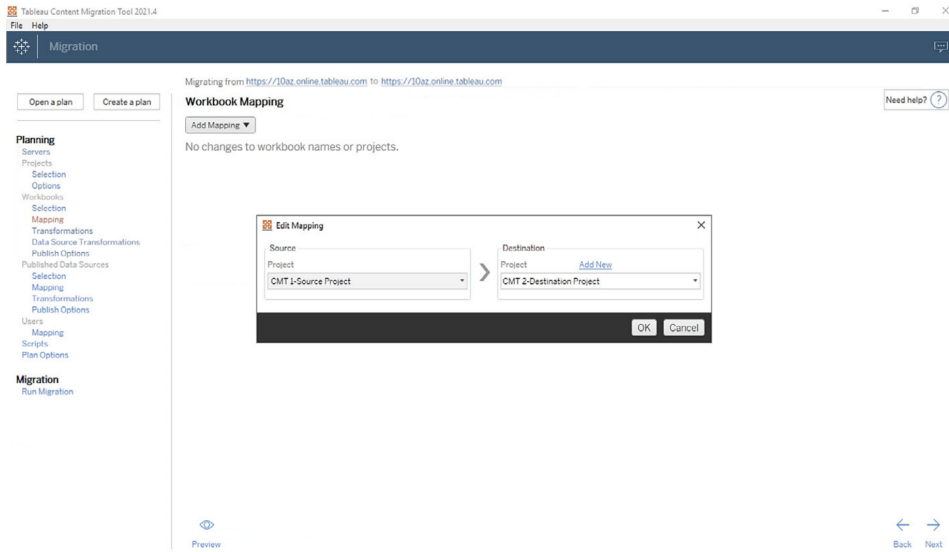
Answering these questions allows you to not only improve the user experience and grow adoption across your Tableau ecosystem, you can also identify internal champions. These champions can share best practices with others, reach out to users who may need help getting started, show the return on your investments into workbooks and data sources, and remove stale content so users can easily find what they need.

Manage content at scale

Content management, a key component of your content governance practices, is essential to enable the effective use of data and analytics by everyone across your organization. Without content management, people will find it increasingly difficult to find what they need among irrelevant, stale, or duplicate workbooks and data sources. The Content Migration Tool automates tasks like content promotion and archiving, ensuring you can meet your organization's content lifecycle requirements and deliver a superior user experience.

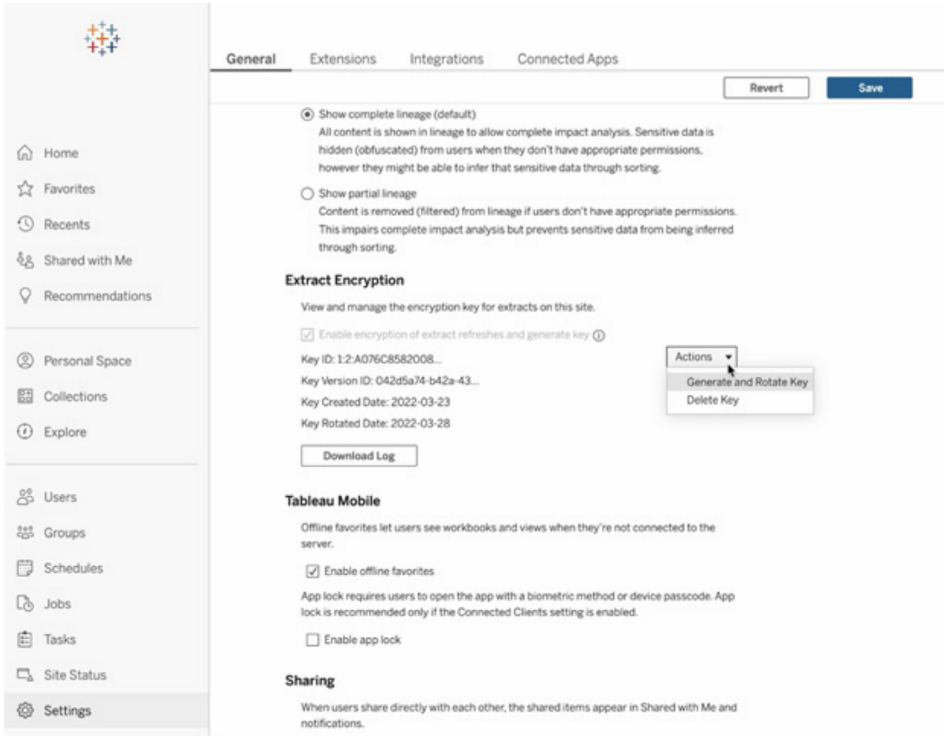
Content management doesn't have to be hard. For example, with a codeless, streamlined, and repeatable migration plan, you can easily promote content between development and production projects in Tableau Cloud. During the content promotion process, you can remap data sources and perform other workbook transformations before sharing the workbook with your users. The Content Migration Tool's user interface walks you through the process of building a migration plan that you can use once, or on a repeatable basis.

Tableau Blueprint Help

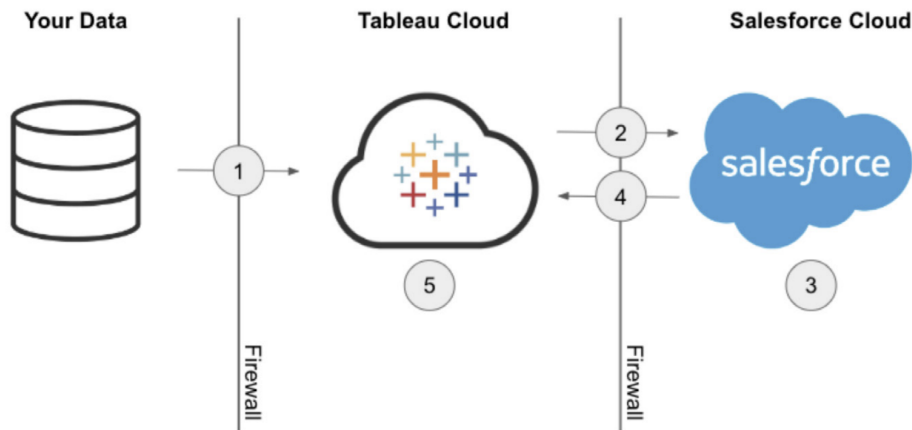


Enhance security

Your data security is important. While data in Tableau Cloud is already encrypted at rest and in transit, some customers have specific security requirements for their encryption keys. Customer-Managed Encryption Keys (CMEK) allow you to create, rotate, audit, and delete your keys without leaving Tableau Cloud.



CMEK leverages Salesforce Shield Key Broker where your Master Encryption Key is stored in Salesforce’s KMS Service and is unique to your site. Leveraging CMEK on top of built-in encryption storage provides a defense-in-depth strategy to protect your data and meet your tough compliance requirements. See below for a high level architecture diagram and explanation.



1. Your data extract is sent to Tableau Cloud.
2. Tableau Cloud checks for CMEK feature enablement and requests an Extract Key from the Salesforce KMS if it's toggled on.
3. The Salesforce KMS creates two versions of your Extract Key, one plaintext and one that is encrypted by your Master Encryption Key. This enables us to leverage envelope encryption. Your Master Encryption Key does not leave Salesforce's KMS.
4. The Extract Key (plaintext) and Extract Key (encrypted) are then sent back to Tableau Cloud. 5. The Extract Key (plaintext) is used to encrypt your extract and then discarded. The Extract Key (encrypted) and encrypted extract are then stored together in Tableau Cloud.

Scale for your enterprise

Analytics success hinges on the ability to provide relevant, up-to-date, and governed data sources to your users. As you begin to leverage new data solutions and your data volumes grow, you can be sure Tableau Cloud will scale alongside you. With Advanced Management for Tableau Cloud, customer sites will have:

- **1 TB of storage**
- **Up to 25 concurrent extract refreshes**
- **25 GB max workbook/data source size**

Data Science Integration

Data science teams use a rapidly evolving and heterogeneous set of tools to draw insights from data. When teams can tie these tools directly into interactive visualizations in Tableau, cutting edge analysis can be seen and understood across organizations. As of Tableau 2020.1, the [Analytics Extensions API](#) creates a new frontier for extending Tableau by allowing developers to integrate new programming languages and software with Tableau's dynamic calculation language, bringing all stakeholders in the data science process together.

Along with the release of the API, Tableau's existing Python, R, and MATLAB External Services are known as "Analytics Extensions." The Analytics Extensions API is based off of the original [TabPy External Services API](#), and TabPy can be considered Tableau's reference API implementation. Users can connect to their own services through the TabPy/External API connection type in Tableau with support for passing credentials via basic authentication and SSL.

One of the core scenarios for Analytics Extensions is the integration of predictive models into Tableau visualizations. Dynamic integrations allow for real-time predictions on the latest data, flexible scenario testing, and predictions on filtered datasets that would be too large to pre-compute. Combining advanced statistical analytics with Tableau gives you the ability to enable users of all skill levels to reap the benefits without deep knowledge of the underlying statistical packages and functions. Additional configuration in Tableau Server is needed to enable external advanced analytics functionality.

For more details about the Analytics Extensions API, join the [Tableau Developer Program](#).

Extensibility

Tableau supports a robust extensibility framework for deep and complex enterprise integrations and embedded analytics solutions. Extensibility spans from administrative task automation to rich visualization integration to enterprise portal applications, bringing any data from any source into a Tableau supported format and delivering system automation with a growing set of standards-based APIs. For more information, see [IT Tools](#) and [Tableau Developer Program](#).

REST API

With the Tableau [REST API](#) you can create, read, update, delete and manage Tableau Server and Tableau Cloud entities programmatically, via HTTP. The API gives you simple access to the functionality behind the data sources, projects, workbooks, site users, and sites on a Tableau Server or Tableau Cloud. You can use this access to create your own custom applications or to script interactions with Tableau resources.

Hyper API

Tableau Server provides direct support and connection to a large number of data sources; however, there are times when you may want to pre-process or access and assemble data from other applications before working with it in Tableau. The [Tableau Hyper API](#) contains a set of functions you can use to automate your interactions with Tableau extract (.hyper) files for Tableau Server 10.5 and later and Tableau Cloud, including the following:

- Create extract files for data sources not currently supported by Tableau.
- Automate custom extract, transform, and load (ETL) processes (for example, implement rolling window updates or custom incremental updates).
- Retrieve data from an extract file.

In addition to supporting all features of the previous Extract API 2.0 for creating extract files, the Hyper API provides access to new features. You can create, read, update, and delete (CRUD) data in .hyper files while leveraging the full speed of Hyper for creating and updating extract files. You can load data directly from CSV files without having to write special code. With the power of SQL to interact with data in .hyper files, the API provides methods for executing arbitrary SQL commands on .hyper files.

Web Data Connector

You can use the Tableau [Web Data Connector SDK](#) to build connectors to additional data sources with Javascript and HTML in Tableau Server and Tableau Cloud. Web data connectors (WDCs) are web pages that provide a data connection that is accessible over HTTP for data sources that don't already have a connector in Tableau. WDCs allow users to connect to almost any data that is accessible over the web and to create extracts for their workbooks. Data sources for a WDC can include internal web services, JSON data, REST APIs, and other sources that are available over HTTP or HTTPS. Users can create their own WDC or use connectors that were created by others. For more information, visit [How to use a web data connector on Tableau Server and Tableau Cloud](#). For more information on community connectors, see [Web Data Connector Forum](#).

JavaScript API

With Tableau's [JavaScript API](#), you can fully integrate Tableau visualizations into your own web applications. The API uses an event-based architecture, providing you with flexibility for round-trip control of users' actions in Tableau visualizations and control of your users' interactions. For example, your enterprise may have a web portal that bridges several lines of business applications as well as dashboards. To make it easier for users, you may prefer to have a consistent UI across all applications. With the JavaScript API, you can create buttons and other controls in your preferred style that control elements of a Tableau dashboard.

Extensions API

With Tableau's [Extensions API](#), developers can create dashboard extensions that enable customers to integrate and interact with data from other applications directly from a Tableau dashboard, such as write-back functionality, custom interactive interfaces, and third-party product integration. Dashboard extensions run in custom dashboard zones and can interact with the rest of the dashboard using the [Tableau Extensions API](#). Available third-party extensions have been published in the [Tableau Exchange](#). To publish to Tableau Server, extensions will

need to be allowlisted ([Windows](#) | [Linux](#)). Tableau Server Administrators can enable on a per-server or per-site basis based on code review and security assessment. For Tableau Cloud, visit [Manage Dashboard Extensions in Tableau Cloud](#).

Document API

The [Document API](#) provides a supported path for modifying Tableau workbook and data source XML. Using Python, you can create a template workbook in Tableau and easily deploy it across multiple servers, update data sources and connections, and evaluate fields within a data source.

TSM API

Tableau Server includes a set of administrative services called Tableau Services Manager (TSM). This set of documentation describes the prerelease [TSM API \(0.5 alpha\)](#), which you can use to perform a wide range of tasks, including start and stop Tableau Server, view the status of services and nodes, backup and restore Tableau Server, make configuration and topology changes, change port assignments for services, and create log file archives.

Metadata API

Tables, data sources, workbooks, and sheets in Tableau Server and Tableau Cloud are available to query via the [Tableau Metadata API](#). The API is fast and flexible and includes common attributes like name, hostname, and URI, as well as type specific information like field data types, and certification. The API will also allow you to query for connected items (e.g. tables and columns used by a specific data source). In addition to the Metadata API, metadata methods are available in the Tableau REST API, which can be found in [Metadata Methods](#) topic.

Mobile App Bootstrap

Develop custom mobile apps with the Mobile App Bootstrap (MAB). The MAB is a sample open-source mobile app that demonstrates how to connect and stay signed in to Tableau Servers, embed Tableau content, and utilize the Tableau JavaScript API to embed the Tableau content you want to have right at your fingertips. For more information, visit [Mobile App Bootstrap – React Native](#), [Mobile App Bootstrap – Cordova](#) or [Mobile App Bootstrap – Objective-C](#).

Webhooks API

Webhooks provide a common way to trigger automated workflows that respond to events in your Tableau deployment. You can start building workflows with Tableau Server 2019.4 and later and Tableau Cloud. For more information, visit the [Webhooks documentation and samples](#).

Tableau License Types

For details on Tableau platform pricing and a license type comparison grid, visit [Pricing for Data People](#).

For help understanding purchased licenses, visit [Understanding License Models and Product Keys](#).

In today's demanding work environment, access to data is crucial for enhancing job performance. We understand that people have different relationships with data. Tableau's role-based licenses cater to users of all skill levels, allowing you to deploy data throughout your organization in a trusted and governed manner.

Our license types—Creator, Explorer, and Viewer—offer varying capabilities to meet different needs. Creators have full functionality access to Tableau Prep Builder, Tableau Desktop, and Tableau Server or Tableau Cloud. They can design, clean, and curate data sources, and create interactive visualizations and dashboards. Explorers, on the other hand, have a subset of Creator capabilities through Tableau Server or Tableau Cloud, enabling them to author new content based on existing data sources and workbooks. Viewers can view and interact with published visualizations and dashboards, benefiting from guided drill paths, filters, and subscription options.

Whether you're a data enthusiast, a Line of Business user, or someone who needs data-driven insights without deep analytics expertise, we have a license type tailored for you. By allocating the appropriate licenses and providing the necessary education, you can ensure that users in your organization have the right tools to excel in their roles.

Tableau Creator

The Creator license is designed for users who create content. This can include the design, cleaning, and curation of data sources, which others will use to analyze governed data, or the

creation of visualizations and dashboards with which other users will interact. It also includes designing governance and permissions models that control which information users may find.

You might be a Creator if...

- Analytics is a fundamental part of your daily responsibilities.
- You frequently merge multiple data sources for analysis.
- You develop or curate data sources for others.
- You engage in data cleaning and transformation alongside analysis.
- You will manage or administer a Tableau Server or Cloud implementation.

You can access the full functionality of the applications below to create content:

- Tableau Prep Builder
- Tableau Desktop
- Tableau Server/Cloud

Tableau Explorer

The Explorer option provides governed authoring and data exploration capabilities for users who don't require the complete data transformation functionalities of Tableau Prep Builder or the ability to connect to raw data sources. Explorers have the freedom to access and analyze published data, create and distribute their own dashboards, and manage the content they have built or been granted permission to edit.

You might be an Explorer if:

- You are a Line of Business data user who enjoys hands-on data exploration.
- You prefer creating visualizations using curated data sources from others.
- You want to customize or edit visualizations and dashboards built by others.
- You are responsible for administering content on a Tableau Server or Cloud site.

As an Explorer, you have access to a subset of Tableau Creator capabilities specifically via Tableau Server or Tableau Cloud for authoring new content based on existing published data sources and workbooks.

Tableau Viewer

Tableau Viewers have the ability to view and interact with published visualizations and dashboards. These users can be granted permission to access published content, explore guided drill paths, apply filters, and even subscribe to dashboards for regular updates and data-driven alerts.

You might be a Viewer if:

- You require data-driven insights for your job but lack the time or skills for extensive analytics.
- You prefer interacting with visualizations created by others rather than building your own.

As a Tableau Viewer, you receive a limited set of capabilities in Tableau Server or Tableau Cloud based on the requirements of someone who primarily views and interacts with data.

The allocation of Creator, Explorer, and Viewer license types within different business groups in your organization will depend on their respective interests and needs. Ensure that users with specific responsibilities are assigned the appropriate license type and provided with the necessary training and education.

Tableau License Management

After purchasing role-based licenses, you should manage them according to your organization's software license processes for allocating to new Tableau users, changing Tableau license levels as analytical skills increasing, and reclaiming available Tableau licenses when someone leaves the company. Login-based license management and grant role on sign in are available in Tableau Server and Tableau Cloud.

With the **core license model**, there are no Creator users that can leverage LBLM. Stacking role-based licenses with a core license will allow the assigned Creator users to activate Desktop and Prep by signing in to a server (LBLM). Contact your Tableau sales representative if you are interested in using the core license model.

Login-Based License Management

Login-based license management, helps you manage licensing for users with Creator roles on Tableau Server and Tableau Cloud. Users with Explorer or Viewer roles cannot use this feature. If you're using Role Based Subscriptions with Tableau Server or Tableau Cloud, you can simplify your license management using login-based license management to eliminate separate Tableau Desktop and Tableau Prep Builder product keys. You only need to manage one or more product keys for on-premises Tableau Server, or in the case of Tableau Cloud, you don't need to manage any product keys at all. For more information, see [Login-Based License Management \(Tableau Server | Tableau Cloud\)](#).

Note: Login-based license management is the default license management and activation option for Tableau Cloud. For Tableau Desktop used with Tableau Server in an on-premises environment, login-based license management requires a special login-based license management-enabled product key. If your Tableau Server is not enabled for login-based license management, contact your Tableau sales representative to obtain a special login-based license management-enabled product key.

Grant Role on Sign In

Beginning in 2020.3, grant role on sign in allows an Administrator to add all individuals at an organization to a given site quickly, without needing to know or assign the appropriate role (Creator, Explorer, Viewer). Instead, a minimum role is assigned to the group to which a user belongs. Until those group members actually sign in, they will remain unlicensed and the minimum role will be granted on a first-come, first-served basis. For more information, see [Grant Role on Sign In \(Tableau Server | Tableau Cloud\)](#)

The benefits of Grant Role on Sign In include:

- Adding all potential users within your organization quickly
- Removes the need for users to request licenses, resolving the potential for Admin bottlenecks
- Only consuming a seat or license for those who actually activate by logging in
- Compatibility with new groups and existing groups
- Time savings due to mitigation of one-off license allocation, saving time
- Synergies with Login-Based License Management to simplify Creator license management
- Eases the transition from legacy or core licensing model to Role Based licensing

BEST PRACTICE RECOMMENDATIONS:

- Make licensing changes before enabling the grant role on sign in option, such as unlicensing users who have never signed in. User's existing site roles won't change when the feature is enabled (only when they sign in). Once enabled, members in the group cannot be "demoted" to a lower role (including unlicensed) without first being removed from the user group.
- Users receiving subscriptions should stay licensed. If you have users receiving subscriptions to Tableau dashboards but aren't signing in to Tableau, this feature will cause their subscriptions to stop working. We recommend keeping these folks licensed (this might be your boss's boss), so they can receive the data they need—even if they rarely or never sign in.
- Enable access for everyone. If you're getting started with Tableau, we recommend bringing all potential users into Tableau as unlicensed users. This way, any user can get instant access while you optimize your usage. You can monitor adoption by looking at the group membership and scale-up licenses as needed.

Tableau Bridge Deployment

Note: This topic applies to Tableau Cloud only.

Most companies have a hybrid data architecture, with data in public cloud environments (i.e., AWS Redshift, Snowflake, Google BigQuery, Azure Synapse, etc.), on-premises environments (i.e., SQL Servers, Oracle, files), and private cloud environments (VPCs). Tableau Bridge makes your private data available, up-to-date, and ready to analyze in Tableau Cloud. Tableau Bridge is client software that runs on a machine in your network, whether this is fully on-premises or within a Virtual Private Cloud.

Tableau Bridge is stand-alone software, provided at no additional cost, to use in conjunction with Tableau Cloud. It's a thin client that you install behind a firewall to enable connectivity between on-premises data and Tableau Cloud. The thin client works in conjunction with Tableau Cloud to keep data sources connected to on-premises data up to date, which Tableau Cloud can't reach directly, through an outbound encrypted connection.

Bridge is designed to scale up and scale out. In most cases, you will own the setup and management of several clients, or a pool of clients, in your organization. Each Bridge can execute multiple live queries and run multiple extract refreshes concurrently.

Management models

Although there are no constraints on setting up and managing Bridge in your organization, your Bridge deployment will likely fall into one of two standard management models. The management model you use, depends on the type of on-premises data that your Bridge deployment needs to support.

For the majority of cases, we recommend that customers utilize a centralized model for managing Tableau Bridge.

- A centralized model means the clients work as a pooled resource, and usage is distributed and load-balanced. This allows customers to scale their Bridge usage easily.
- If the customer's data sources span multiple network segments with restricted communication, then it is best to utilize a mixed management model as Bridges will need to be deployed in each segment to communicate directly with Tableau Cloud.

Centralized management

A centralized management model supports the pooling of clients and is optimized for keeping relational data fresh. With clients configured for pooling, live queries and refresh jobs happen in parallel across available clients.

For example, if you have 20 refreshes and have five running and available clients, you can expect each client to be allocated to run four refresh jobs each.

Using this model means:

- As the site admin, you can set up and take down Bridge clients as needed.
- For data source owners, this means they can:
 - Have uninterrupted publishing workflows that detect whether Bridge is required.
 - Edit or update database credentials directly from Tableau Cloud.
- Schedule refreshes from Tableau Cloud directly using Recommended Schedules.
- For file data, Centralized Management provides access to data available across your organization (such as files in a network share). If a file is only available on a specific machine, see the following sections.

Mixed management

A mixed management model is required if Bridge facilitates connectivity for data sources that connect to data available in the network and file data only available on an individual machine.

With this model, in addition to the benefits of the centralized management model, “named” or designated clients must be managed separately to support some file data.

Using this model means:

- When scheduling refreshes, data sources that connect to file data need to be assigned to a specific client. When scheduling a refresh, the client is only visible to the data source owner if he or she is signed into the client itself under the same Tableau Cloud account.
- Only one refresh can happen at a time for data sources that connect to file data. If you need refreshes to occur simultaneously, consider designating additional “named” clients to support higher throughput.
- If you, as the site admin, want to maintain ownership of the client, you must also own the data sources assigned to the specified client.

Key Considerations for deploying Tableau Bridge:

- When planning your deployment, as the site admin, it’s important to know what data your users are connecting to, the type of connections they’re using, and how those connection types affect how data sources can be managed. For more information, see the [Connectivity with Tableau Bridge](#) topic.
- Understand the hardware guidelines for virtual environments running Bridge. For more information, see the [Recommended Hardware for Tableau Bridge](#) topic.
- To take advantage of the latest security and feature updates, always install the Bridge client’s latest version from the [Tableau Bridge Releases](#) page. For more information, see the [Install Bridge](#) topic.
- Installing and setting up Bridge is simple. However, there are a few additional steps you must take before proceeding with your deployment. For more information, see the [Deploy Bridge](#) topic.
- Use [Concurrency Capacity](#) to determine the number of Tableau Bridges to deploy for your organization. As a best practice, we recommend you set up one additional Tableau Bridge than you need in case one Bridge or virtual machine is down unexpectedly. For more information, see the [Pooling Capacity](#) topic.

For more information, see:

- [Tableau Bridge Homepage](#)
- [Getting Started with Tableau Bridge](#)
- [Plan Your Bridge Deployment](#)
- [Connectivity with Tableau Bridge](#)
- [Tableau Bridge Security](#)

Tableau Desktop and Tableau Prep Builder Deployment

Administrators will distribute and install [Tableau Desktop and Tableau Prep Builder](#) for Creator-licensed users. If you choose to create a packaged installation file, you can customize the install and not have any prompts for the end user during the install process. When you install Tableau Desktop or Tableau Prep Builder on a Windows or Mac computer, default database connectivity drivers are installed. For a complete list of default drivers, see [Before You Install](#). If you prefer that some or all of these drivers not be installed, you can customize the list from the Customize pane in the installation program for Tableau Desktop. If [additional drivers](#) are needed beyond the default, they will need to be installed on each computer.

Virtual desktop support gives you the ability to optimize your installations of Tableau for non-persistent virtual desktops or for computers that are regularly re-imaged. With virtual desktop support enabled, Tableau license product keys or login-based license management are automatically deactivated after a predetermined amount of time if Tableau Desktop or Tableau Prep Builder cannot connect to a Tableau-hosted service that confirms the validity of the license. This means you do not need to perform a refresh or deactivation when using Tableau license product keys or login-based license management. For desktops using Tableau license product keys, the requirement is to periodically connect to the Internet. The requirement for login-based license management virtual desktop is to communicate with the Tableau Server. For more information, see [Configure Virtual Desktop Support](#).

BEST PRACTICE RECOMMENDATION:

Using login-based license management is highly recommended to decrease the maximum activation errors, improve the Virtual Desktop experience, and remove the need to manage product keys.

When using login-based license management, the ability to view Desktop usage is available on Tableau Server with a default Administrative view. If using product keys, it is possible to set up and configure Desktop License Reporting with instructions in [Configure Desktop License Reporting](#) and continue the server-configuration as outlined in the License Tracking section.

Tableau Mobile Deployment

Mobile business intelligence enables any user to make decisions no matter where they are. We're no longer shackled to our desks; we're on the go, visiting customers, traveling, or walking

the shop floor. With Tableau, any workbook you create is automatically mobile-enabled when accessed from a device. You can pinch to zoom, swipe to scroll, and leverage other touch-optimized interactions like quick filters. You can also edit workbooks and create new views to answer new questions from your data. This works seamlessly in a mobile browser, with an embedded viz in custom mobile apps, and in the Tableau Mobile app itself.

Key considerations for deploying Tableau Mobile are listed in the [Tableau Enterprise Architecture Survey](#) on page 36 of the [Tableau Blueprint Planner](#). The following roles should be involved in the mobile deployment: Network Administrator, Security Administrator, and Mobile Device Management Administrator along with the Tableau Server or Tableau Cloud Administrator, content authors, and business users with specific mobile requirements.

Tableau Mobile App Distribution

Organizations have various strategies for distributing mobile apps to their users. Many enterprises distribute apps via a Mobile Device Management (MDM) platform, these provide precise control over how and to whom the app is deployed. In addition to controlling app delivery, MDM platforms let you customize the Tableau sign-in experience, configure app policies, and provide additional security and governance controls. They can also make the sign in process easier. In this scenario, a user with a device enrolled in their organization's MDM platform would go to the internal app store provided by the MDM platform and download the app from that catalog.

To manage Tableau mobile deployments, we recommend using mobile device management (MDM) or mobile application management (MAM). The following are supported mobile management systems: Blackberry Dynamics, VMware Workspace ONE, MobileIron, Citrix Endpoint Management (formerly XenMobile), and Microsoft Intune. Users will see touch-optimized views on Apple iPad and iPhone, Android phone and tablet, as well as mobile browsers. For more information, visit [Tableau Mobile Deployment Guide](#).

For organizations who haven't invested in MDM, users can simply download the Tableau Mobile app from public app stores, and then connect directly to the service.

Securing Mobile Data

Security is paramount in any mobile deployment. Mobile devices will be out and about in the wild. They will be used on different networks. They may even include users' personal devices if your organization supports a bring-your-own-device (BYOD) policy. It's critical that your data remain secure both in transit and at-rest.

If you use Tableau Cloud, we securely connect to data for you so there's no additional effort on your part. Tableau Cloud by default leverages SSL communications and the Tableau Mobile app supports it by default. If you use Tableau Server, SSL should be configured . This ensures that all to- and from-traffic is encrypted and helps avoid potential man-in-the-middle attacks.

You must also determine how your Tableau Server will be reachable by a mobile device if the device isn't on the same network or the internet. There are two options to tunnel through your corporate firewall to reach the server: connect via a VPN, or use a reverse-proxy server. The choice of which option is best for your organization depends on many factors, such as whether you have an existing solution (VPN or proxy) that you can use, licensing costs, security considerations, and user experience. Ensure that the cross-functional project team discusses this topic and understands the options. Because Tableau Cloud is a fully-hosted SaaS offering, it can be accessed from the Internet with valid login credentials to your site.

The final piece of security involves data-at-rest, which Tableau takes care of for you. All information that gets persisted on a device, such as metadata about content, snapshot images, and access tokens, is securely stored using native OS encryption. As a best practice, consider regularly confirming overall data security by having a third-party security specialist audit your organization.

Sign-in Seamlessly

Before users can get to their data, they have to sign in to the Tableau Server or Tableau Cloud. While this may sound obvious, ensuring that users have a secure, seamless experience is critical. If users struggle to sign in, they'll give up on mobile workflows, undermining your entire deployment effort. The value of Tableau Mobile is realized when people have access to data when and where they need it. To streamline sign-in, we recommend using a single-sign on (SSO) technology like Active Directory, SAML, or Kerberos. SSO lets users use their existing set of corporate network credentials rather than having to memorize something new.

In addition to SSO, we recommend leveraging additional capabilities provided by MDM platforms to improve the sign-in experience. With MDM, you can display a preset list of servers to connect to, and even automatically fill in their user ID. MDM can also push out policies and certificates, so that everything is pre-installed and configured ahead of time. For example, with Kerberos authentication, MDM can push certificates to devices so that authentication happens behind the scenes and users aren't even prompted for credentials. MDM can also automate tasks such as loading a VPN client in the background when needed, eliminating a bunch of initial steps for users so they can go to the app and directly connect to their data. Anything you can do to reduce friction in the sign-in experience will pay off in greatly increased mobile usage.

Configure Offline Access

As mobile users travel offsite, their internet connectivity can vary, so a seamless offline experience is a big benefit. For quick offline access on mobile devices, Tableau Mobile automatically caches high-resolution snapshot images of a user's favorite views. When users know they're about to go offline for a period of time, they can manually refresh snapshot images in the app. On iOS, snapshots are also regularly refreshed in the background. Snapshots are beneficial even when users have connectivity because they provide at-a-glance access to the most important content. For example, users can pan and zoom snapshots to zero in on areas of interest and swipe between them as they're walking between meetings. When a user finds something of interest in a snapshot, they can tap it to go to the interactive view and answer additional questions with their data. As an administrator, you can disable cached snapshots for specific sites, but in most cases you'll find that the advantages of snapshots access outweigh any security concerns, as snapshots exclude the raw underlying data and are stored encrypted on the device.

Rollout and Support

Pilot your mobile rollout by testing it with a small group of users first. After addressing any issues you uncover, extend the rollout to your entire organization, with accompanying step-by-step instructions that help users quickly set up their devices. An initial, in-person training session can dramatically speed up adoption, particularly if your organization uses unique deployment options.

If you use Tableau Server, consider creating custom admin views for mobile, drawing upon the rich database of user behavior stored in the Tableau Server repository. To continuously improve your organization's mobile experience, capture feedback from users while they're on the go. Successful approaches include a weekly "mobile office hours" meeting that anyone can dial into, and an email alias specific to mobile support that routes issues right to your group.

Tableau Support Programs

If you need to open a case with Tableau Support, follow the steps in the [Submitting a Case From the Webform](#) Knowledge Base article.

Tableau Software offers three support levels to help meet the service needs of all customers.

- Standard Support is included with a subscription purchase, the first year of a perpetual license or with Annual Maintenance Renewal after the first year of a perpetual license.

- [Extended Support](#) enables your organization to avoid or reduce downtime and expedite the value of your investment through accelerated response times and the additional availability of 24 x 7 weekend support for critical P1 issues.
- Premium Support provides complete, proactive account care you can rely on. Premium Support provides a comprehensive set of resources, extended availability, Root Cause Analyses, and the fastest response time to service issues. For more information, see [Tableau Premium Support](#).

For more information, see [Technical Support program levels](#).

Tableau Monitoring

As more and more users are onboarded and the use of analytics grows across your organization, Tableau becomes mission-critical for data-driven decisions. Without monitoring, a “set-it-and-forget-it” deployment can be met with inadequate resources that fail to support the workload of highly-engaged users. Ongoing, proactive monitoring is required to operate and support your deployment at scale and meet the expectations of your user community.

Because Tableau is integrated with your enterprise architecture—including hardware, network, databases, and applications—understanding how everything interoperates is key for routine monitoring from performance to troubleshooting. The monitoring function is focused on these systems and their integration with Tableau Server or Tableau Cloud. It is primarily technical in nature and performed by IT roles. Tableau Server Administrators or Tableau Cloud Site Administrators will work together to ensure the platform meets evolving business needs.

BEST PRACTICE RECOMMENDATION:

Combine monitoring data with [Measurement of Tableau User Engagement and Adoption on page 233](#) data to shape new behaviors and accelerate towards your goal of becoming more data-driven by taking these insights into [Internal Tableau Activities on page 287](#) like admin, user, and champion group meetings.

For example, if you found numerous data sources with scheduled refreshes and workbooks that have not been accessed in 180 days, you can add a session on the content management policy for archiving and deleting stale content.

For Tableau Server, you can use a combination of hardware utilization monitoring, data from Tableau Server’s Repository, and external tools to understand and monitor the health of Tableau Server and how analytics are being consumed. Licensed as part of [Tableau Advanced Management, Resource Monitoring Tool](#) is an agent-based monitoring application. Resource Monitoring Tool offers enhanced insights into the health and performance of a Tableau Server cluster by parsing and analyzing the logs generated by overall Server usage and combining that with monitoring of physical system usage (CPU Usage, RAM, Disk I/O etc.). In addition, standard enterprise monitoring platforms, such as Splunk, New Relic, or other agent-based utilities, can be used for monitoring. With all the data that Tableau and these solutions collect, Tableau Desktop should be used to analyze activity on your Tableau Server.

It is just as important to monitor for things that go right as it is for things that go wrong. With viral adoption of Tableau in your organization, you will need to be responsive to the increased workloads and proactively scale to avoid resource constraints. On the other hand, assuming a

correctly-sized hardware configuration is deployed initially, unmonitored hardware utilization and user workloads, inefficient workbooks, suboptimal data extract design, and peak-hour data refresh schedules can have a major impact on server performance and user experience, causing performance to degrade from the cumulative effect of the separate incidents.

For Tableau Server monitoring and operations, systems administrators and Tableau Server Administrators should perform the following tasks:

- Set up tools to monitor hardware utilization and maintain sufficient headroom for future growth and peak usage spikes.
- Configure built-in alerts and incidents to notify you of events and thresholds.
- Use default administrative views to identify background task success/failure and job queuing, slow workbooks, disk usage, and license allocations.
- Create custom administrative views from repository data for deeper analytics on your deployment and set custom data-driven alerts for your own organization's policies and goals.
- Troubleshoot problems with Tableau Server logs.

Because Tableau Cloud is a SaaS analytics platform, Tableau monitors the infrastructure and operations; however, Tableau Cloud deployments still have monitoring tasks:

- Subscribe to [Tableau Trust](#) updates to get email, text, and Atom Feed or RSS Feed notifications when Tableau creates, updates or resolves an incident. At any time, you can visit the [Tableau Trust](#) page to view system status.
- Monitor other systems that are integrated with Tableau Cloud such as authentication, database, and network connectivity.
- Use default administrative views to identify background task success/failure and job queuing, slow workbooks, disk usage, and license allocations.
- Create custom administrative views from Tableau Cloud Admin Insights for deeper analytics on your deployment and set custom data-driven alerts for your own organization's policies and goals.

Monitoring Roles and Responsibilities

During the initial planning stage, [Tableau Project Team Roles and Responsibilities on page 72](#) were defined and assigned. These same roles will have specific monitoring responsibilities for their respective technology areas. At a minimum, you must have a Tableau Server Administrator or a Tableau Cloud Site Administrator.

Tableau Admin Role	Monitoring Responsibilities
Tableau Server Administrator	The Tableau Server Administrator monitors overall server health including server usage patterns, process status (up/down/failover), job status (success/failure), disk drive space, and stale content.
Tableau Cloud Site Administrator	Tableau Cloud Site Administrators monitor license provisioning, usage patterns, Tableau Bridge activity, job status (success/failure), space usage, and stale content.

Depending on the size of the organization and the degree of specialization for a particular role, the external-to-Tableau monitoring responsibilities may be centralized or split across different teams. You may find that each of the organizational roles listed below equates to one person in a large organization, while more than one person may serve different roles in smaller organizations. What is most important is that each role monitors their respective area, rather than the number of people.

Role Name	Monitoring Responsibilities
Systems Administrator	The Systems Administrator monitors Tableau Server infrastructure and resource utilization (processor, memory, disk) or Tableau Bridge pool availability and activity.
Database Administrator	The Database Administrator monitors the database infrastructure for resource utilization and assists with modeling, structuring, and optimizing sources of data that connect to Tableau.
Security & Compliance Administrator	The Security & Compliance Officer monitors for compliance with company security and data security policies and external regulatory requirements such as accounts/passwords and PII.
Network Administrator	The Network Administrator monitors network communications and connectivity, including SSL, VPN, Tableau Bridge, and mobile networking to

Role Name	Monitoring Responsibilities
	access Tableau.
Client Administrator	The Client Administrator monitors client software installation including versions, database drivers, including Tableau Desktop, Tableau Prep Builder, Tableau Mobile, and Tableau Bridge.
Mobile Administrator	The Mobile Administrator monitors Tableau Mobile app installation, utilization, and versions.

Regardless of the deployment size, performance is a shared responsibility among administrators and users. This makes both monitoring and measurement equally important for overall success.

- For Tableau Server, a Systems Administrator may be responsible for the hardware and operating system only using enterprise monitoring platforms, while Tableau Server Administrators will monitor the health of Tableau Server and track key application metrics. Tableau Server Site Administrators or Project Leaders will measure content metrics in their respective site(s) or project(s), which can have significant impact on system performance and stability. Until content and engagement measurement responsibilities are delegated to Site Administrators or Project Leaders, these metrics should be monitored and measured by the Tableau Server Administrator.
- For Tableau Cloud, the Tableau Cloud Site Administrator will monitor application-level metrics. Site Administrators or Project Leaders will measure content metrics in their respective site(s) or project(s) by enabling Admin Insights and delegating responsibilities. Until content and engagement measurement responsibilities are delegated to Project Leaders, these metrics should be monitored and measured by the Tableau Cloud Site Administrator.

For more information on content and engagement metrics, see [Measurement of Tableau User Engagement and Adoption](#) on page 233.

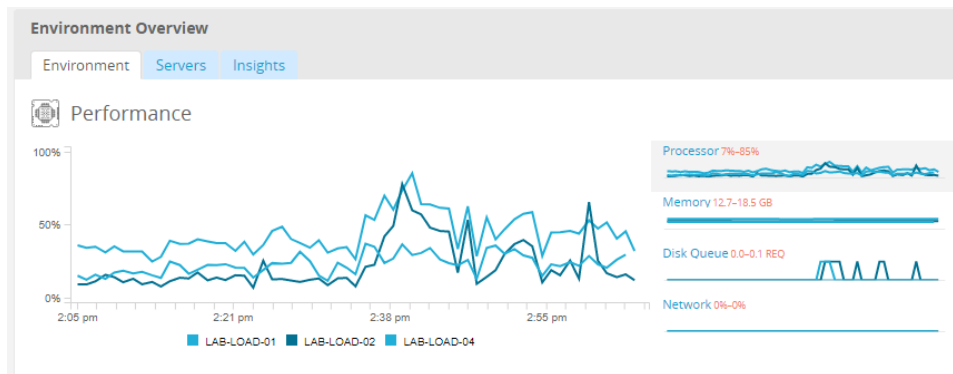
Hardware Monitoring

Any application is only as reliable and performant as the hardware that it runs on. It is important that the underlying infrastructure of your Tableau Server deployment be routinely monitored for

capacity constraints to prevent overtaxing the system, whether it's physical servers or virtual machines, on-premises or in the cloud. Systems administrators should monitor CPU, memory usage, storage I/O, storage space, and network bandwidth utilization.

Tableau Server

Beginning with 2019.3 and licensed as part of the [Tableau Advanced Management](#), the [Resource Monitoring Tool](#) provides a comprehensive look at the health of Tableau Server using a web user interface for all of its features. The [Resource Monitoring Tool Agent](#) runs on each of the nodes in your Tableau cluster to monitor their hardware utilization, performance, and activity, which are collated by the [Resource Monitoring Tool Master Server](#). Processor, Memory, Disk Queue, and Network are sampled using WMI several times per second to produce averages. An Environment Down event, which is logged as critical, is monitored at a 15 second polling interval by default and follows a three-strike rule. If the status is offline, or does not reply within 30 seconds, for three consecutive polling intervals then a critical incident is created. For more information, see [Performance](#) and [Environment Down](#).



BEST PRACTICE RECOMMENDATION:

To maintain sufficient headroom and reduce the likelihood of resource constraints, calculate the following values based on your hardware specs and set Resource Monitoring Tool [Hardware incident thresholds](#) to the following:

- CPU over 80% for 5 minutes
- Memory less than 25% available
- Disk less than 20% available

Depending on your enterprise monitoring approach, hardware monitoring can be done with an agent-based enterprise monitoring service or with [PerfMon](#) on Windows ([sample workbook](#)). Linux admins will use the `sysstat` tools or `vmstat` to collect data to be analyzed in a workbook

similar to the Windows version. When deploying on virtual platforms, such as VMware, HyperV, or Citrix, or in the public cloud, including [AWS](#) (CloudWatch), [Microsoft Azure](#) (Azure Portal), and [Google Cloud Platform](#) (Google Stackdriver), these platforms have their own utilities for monitoring the health of their virtual machines. These tools usually have support for automatically monitoring your infrastructure and alerting you when your preset thresholds of 75-85% utilization are exceeded.

Alternatively, [TabMon](#) is a freely available open source Tableau Server cluster-monitoring tool. TabMon provides structured output that is analyzed with Tableau Desktop. For more information, watch [A Tour of the TabMon Sample Workbook](#) that shows how to monitor CPU, memory usage, storage I/O, storage space, and network bandwidth at the Tableau Server Process level. This information will help you understand when to scale Tableau Server. In the TabMon.config file, you should monitor every 300 seconds and keep data for 30-day intervals to manage the size of the database.

Tableau Cloud

One of the benefits of Tableau Cloud is that it is managed and optimized by Tableau because it is a SaaS analytics platform. If you are connecting to on-premises data, Tableau Bridge availability and activity should be monitored. As a site administrator, you can monitor Tableau Bridge client in a couple of ways:

- [Monitor traffic to data sources](#) with live connections using the built-in administrative view
- [Monitor client status on the site settings page](#)
- [Monitor Bridge extract performance](#) using the built-in administrative view
- Set up data source owners for extract refresh notifications

It's important to note that data source owners are the users who receive emails when data sources fail. This is especially relevant in the centrally managed model, because the owners of the Bridge clients are the site admins, and it is commonly necessary to get them involved when issues occur and need troubleshooting. Because they will not be automatically notified, data source owners who are not the owner of the Bridge client generally set up automatic email forwarding to site admins to keep them up to date on issues.

As a data source publisher, if you believe an extract is taking an unusual amount of time, there are several things you can do to troubleshoot. An extract refresh through Bridge has two components: taking the extracts locally with Bridge, and then sending that extract to Online and having it become available. To isolate the potential cause of the issue, it may be prudent to take the same extract in Tableau Desktop and compare the extract duration with the time it takes for

Bridge to take an extract. Any anomalies there should be reported to your Tableau contact for review and support.

Built-in Alerts

Tableau Server

If Tableau Server processes go down, the application state will be degraded or even fail depending on the process that goes down. During installation and configuration ([Windows](#) | [Linux](#)), Tableau Server was **configured with an SMTP email server** to notify the specified email distribution list about **system alerts and failures**. With system alerts enabled, you will be notified by email of process up, down, and failover events and drive space constraints. See below for recommended settings.

Events
You can specify which server events will trigger an email notification. We recommend enabling all notifications. [Learn more.](#)

Content updates

- Send emails for extract refresh failures
- Allow users to receive email for views that they have subscribed to

Server health monitoring

- Send emails for Tableau Server process events (up, down, and failover)
- Send emails for Tableau Server license reporting

Drive space

- Send emails when unused drive space drops below thresholds

Warning threshold %

Critical threshold %

Send threshold alert every minutes

- Record disk space usage information and threshold violations for use in custom administrative views

BEST PRACTICE RECOMMENDATION:

Enable system health monitoring in Tableau Services Manager for process up, down and failover events, license reporting, and disk space. Use an email distribution group of administrators rather

than an individual's email address for notifications. If you are using the [Resource Monitoring Tool](#), keep thresholds synchronized.

Tableau Cloud

Tableau Cloud Site Administrators should subscribe to [Tableau Trust](#) updates to get email, text, and Atom Feed or RSS Feed notifications when Tableau creates, updates or resolves an incident. At any time, you can visit the [Tableau Trust](#) page to view system status.

For extract refresh failures, the Tableau Cloud Site Administrator should enable Tableau Cloud to send email to the owner of a data source when its scheduled extract refresh does not complete successfully. The data source owner can then opt out individually in their account settings. For more information, see [Notify Owners When Extract Refreshes Fail](#). For data sources that are refreshed through Tableau Bridge, notifications will vary. For more information, see [Manage Email Alerts for Bridge](#).

Resource Monitoring Tool Incidents

Note: This topic applies to Tableau Server only.

Beginning with 2019.3 and licensed as part of the [Tableau Advanced Management](#), the [Resource Monitoring Tool](#) provides a comprehensive look at the health of Tableau Server using a web user interface for all of its features. The [Resource Monitoring Tools Agent](#) runs on each of the nodes in your Tableau cluster to monitor their performance and activity, which are collated by the [Resource Monitoring Tool Master Server](#).

Incidents should be configured and used to help detect when unusual situations occur, which include a variety of events for both Tableau Server and the server it is running on. Global incidents can be configured, but they may be overridden per environment. There are three levels of incidents: Info, Warning, and Critical. For more information, see [Tableau Resource Monitoring Tool - Incidents](#).

In addition to Hardware and Environment Down that are described in [Hardware Monitoring](#), incidents will be logged for the following reasons:

- [Extract Failures](#) - logged as a warning when there is an extract failure in Tableau.
- [Slow Queries](#) - logged if a query exceeds threshold. By default, a Slow Query incident will trigger a warning if any data query takes at least 30 seconds to execute.

- **Slow View** - logged if view request exceeds threshold. By default, a Slow View incident will trigger a warning if any view request takes at least 1 minute to load.
- **Agents Unlicensed** - logged as critical if Tableau Server has not been properly licensed to use Tableau Resource Monitoring Tool.

Tableau Server Process Status

Note: This topic applies to Tableau Server only.

When Tableau Server is functioning properly, most processes will show as Active, Busy or Passive (Repository). The list below shows possible process states:

- **Active** — The process is functioning as intended. See File Store in [Troubleshoot Server Processes](#) for details on possible active states.
- **Busy** — The process is completing some task. See File Store and Repository in [Troubleshoot Server Processes](#) for more information.
- **Passive** — The repository is in passive mode.
- **Unlicensed** — The process is unlicensed.
- **Down** — The process is down. The implications of this differ depending on the process.
- **Status unavailable** — Tableau Server is unable to determine the status of the process.

To find the status of processes, go to the [Tableau Server Status page](#) or [Tableau Services Manager status page](#). These pages include Tableau Server processes, along with links to troubleshooting documentation if a process is not running as expected. If you hover your mouse pointer over the status indicator for a process, a tooltip shows the node name and the port the process is running on.

The screenshot shows the Tableau Server Resource Monitoring Tool interface. At the top, there are navigation tabs for STATUS, MAINTENANCE, and CONFIGURATION. The status bar indicates 'Tableau Server is running' and a 'sign out' button. The main table displays the status of various processes across three nodes (node1, node2, node3). Each process is represented by a row, and its status on each node is indicated by green checkmarks (Active), blue squares (Busy), red squares (Error), or grey squares (Stopped). A legend at the bottom identifies these status indicators.

Process	node1	node2	node3
Gateway	✓	✓	✓
Application Server	✓	✓	✓
VizQL Server	✓✓✓✓	✓✓✓✓	✓✓✓✓
Cache Server	✓✓	✓✓	✓✓
Cluster Controller	✓	✓	✓
Search & Browse	✓	✓	✓
Backgrounder	✓✓	✓✓	✓✓
Data Server	✓✓	✓✓	✓✓
Data Engine	✓	✓	✓
File Store	✓	✓	✓
Repository	✓		✓
TSM Controller	✓		
License Server	✓		

Legend: ✓ Active, ■ Busy, ■ Error, ■ Stopped

Beginning with 2019.3 and licensed as part of the [Tableau Advanced Management](#), the [Resource Monitoring Tool](#) provides a comprehensive look at the health of Tableau Server using a web user interface for all of its features, including process status. The Resource Monitoring Tool polls Tableau Server's `http://{TableauServerUrl}/admin/systeminfo.xml` page every 15 seconds (by default) to check the status. If the status is offline, or does not reply within 30 seconds, for three consecutive polling intervals then a critical incident is created. For more information, [Environment Down](#).

To integrate with external enterprise monitoring tools, use the TSM REST API to get the [status](#) of each process.

BEST PRACTICE RECOMMENDATION:

In case of an error, review [Troubleshoot Server Processes](#) in Online Help and take a log snapshot if you need to contact Tableau Support for further assistance.

Administrative Views for Monitoring

Data from Tableau Server or Tableau Cloud can be analyzed using default administrative views ([Tableau Server](#)| [Tableau Cloud](#)), custom administrative views, and [Tableau Accelerators](#).

Tableau Blueprint Help

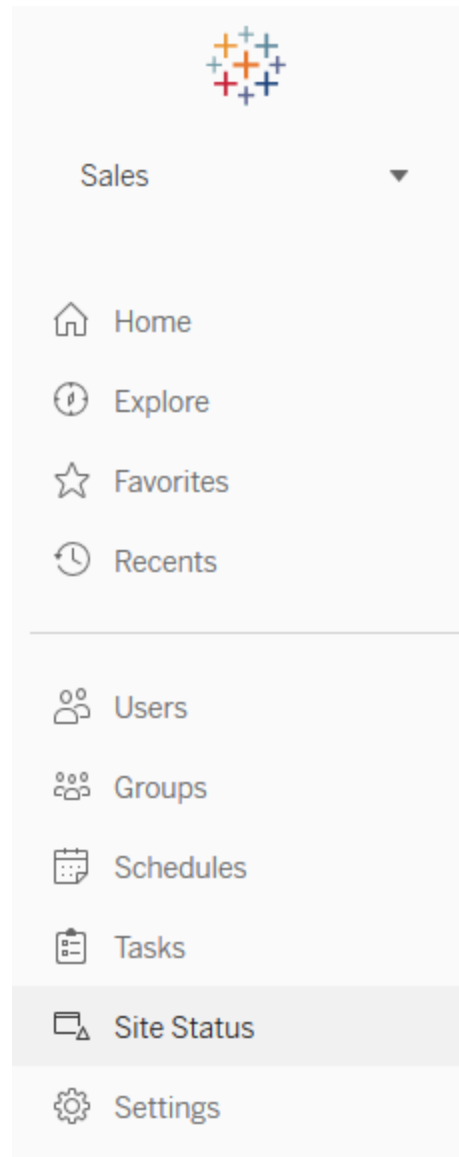
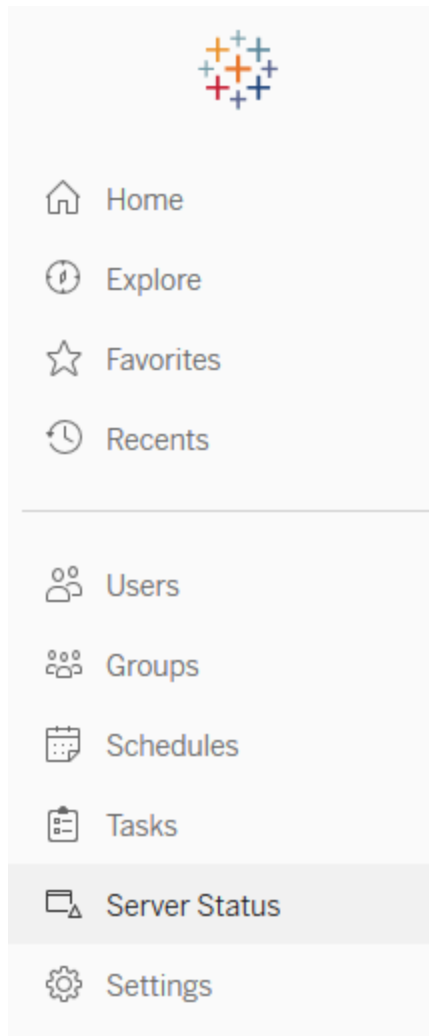
Administrative views are dashboards that are included with Tableau Server or Tableau Cloud and help you understand system utilization and how users are interacting with content so that you can proactively monitor system activity and other scheduled tasks.

To access administrative views in Tableau Server or Tableau Cloud your **site role** must be set to either Server Administrator or Site Administrator. Tableau Server Administrators can view administrative views for all server activity; Tableau Site Administrators have access to Tableau Server's default administrative views limited to their respective site. For Tableau Cloud, Site Administrators have access to default administrative views for their respective site, as well as Tableau Cloud, including a starter workbook and curated data sources.

Navigate to Administrative Views on the Server or Site Status Page as shown below.

Server Status

Site Status



BEST PRACTICE RECOMMENDATION:

Regularly spend time understanding the Tableau usage patterns and system utilization.

- Tableau Server: Understand how the application is performing throughout the day. Keep a close watch on background tasks, such as extract refreshes and subscriptions, to make sure they are executing on time and during off-peak hours/periods as much as possible. Isolating the Backgrounder processes to their own node is recommended for heavy

extract workloads.

- Tableau Cloud: Understand the success/failure of scheduled tasks and Bridge resource utilization.

Default Administrative Views

Brief descriptions of the default administrative views that are most applicable to Tableau Server Administrators and Tableau Cloud Site Administrators are shown below:

- Background Tasks for Extracts — Completed, pending, and failed extract task details with full details of why an error occurred. ([Tableau Server](#) | [Tableau Cloud](#))
- Traffic to Bridge Connected Data Sources — ([Tableau Cloud](#))
- Bridge Extracts — ([Tableau Cloud](#))
- Background Tasks for Non Extracts — Completed, pending, and failed non-extract background task details with full details on why an error occurred. ([Tableau Server](#) | [Tableau Cloud](#))
- Background Task Delay — Difference between scheduled and actual start times of background tasks. Use the view to help you identify places you can improve server performance by redistributing task schedules and optimizing tasks. Background Task delays are an important metric to determine whether you should isolate Background processes and scale out to add additional capacity for data refreshes. ([Tableau Server](#))
- Stats for Load Times — View load times and performance history. ([Tableau Server](#))
- Performance of Views — Overall distribution of view load times and slowest views in a given time period. Compare spikes in the number of sessions with spikes in slow load times to identify the times of day when high user traffic is slowing down the server. ([Tableau Server](#))
- Performance of Flow Runs – view to see the performance history for all the flows on a site. ([Tableau Server](#) | [Tableau Cloud](#))
- Stats for Space Usage — Space used by published workbooks and data sources, including extracts and live connections. ([Tableau Server](#) | [Tableau Cloud](#)).
- Server Disk Space — Current and historical disk space usage, by server node. Use the Server Disk Space view to see how much disk space is in use on the server(s) that run Tableau Server, where disk space refers only to the partition where Tableau Server is installed. You can also use this view to identify sudden changes in disk space usage. ([Tableau Server](#))
- Stale Content — ([Tableau Server](#) | [Tableau Cloud](#))

- **Tableau Desktop License Usage** — Summary of usage for Tableau Desktop licenses. Manage licenses efficiently and determine if you need more or fewer licenses. This view is only available to server administrators.
- **Tableau Desktop License Expirations** — Expiration information for Tableau Desktop licenses. This view is only available to server administrators.

The following default administrative views will be monitored primarily by Site Administrators and Project Leaders, which are covered in **Measurement of Tableau User Engagement and Adoption** on page 233

- **Traffic to Views** — Usage and users for published views. Compare the traffic to the expected audience size.
- **Traffic to Data Sources** — Usage and users for published data sources. Compare the traffic to the expected audience size.
- **Actions by All Users** — Actions for all users to see site activities.
- **Actions by Specific User** — Actions for a specific user, including items used.
- **Actions by Recent Users** — Recent actions by users, including last action time and idle time.

BEST PRACTICE RECOMMENDATION:

Publish the Tableau admin workbooks for creating data-driven alerts aligned with your thresholds.

- **Tableau Server:** You should publish and extract the default administrative views workbook and set your alerts. After opening the administrative views in Tableau Server, you can copy the temp workbook to your computer, open in Tableau Desktop, and publish to Tableau Server for others to view. In Tableau Server 10.x to 2018.1, the location is “Tableau Server\data\tabsvc\temp”. In 2018.2 and later, it can be under any vizql server process. For example: Tableau Server\data\tabsvc\temp\vizqlserver_1.20182.18.0627.2230.

In the published admin views workbook, set **data-driven alerts** on the Stats for Space Usage and Stats for Load Times views to identify which workbooks and data sources exceed the expected size limit or load time according to your governing standards. For example, if you have a < 10 second load time standard, the data-driven alert will notify you of load times > 10 seconds. Similarly, if you have a 1GB standard for workbook or data source size, the data-driven alert will notify you of workbooks or data sources > 1GB.

- Tableau Cloud: Copy the Admin Insights starter workbook to a new project and set your alerts. Some examples include login activity to see if your user base falls below a certain threshold and publishing activity.

Custom Administrative Views

Custom administrative views are useful for deeper analysis of user behaviors and organization-specific KPIs that are identified. For Tableau Server, you can start with the default administrative views, connect to the Tableau Server Repository to create your own connections, use [Tableau Server Insights](#), which are curated data sources to perform deeper analysis on your deployment.

BEST PRACTICE RECOMMENDATION:

Grant permission to Tableau Server Insights or Tableau Cloud Admin Insights data sources as a starting point for further analysis by others in custom administrative views. For more information on managing Tableau Cloud Admin Insights, see [Tips for Managing Admin Insights](#).

Available for download from GitHub, [Tableau Server Insights](#) data sources are shown below:

- TS Background Tasks — Primarily for analyzing Extract Refresh and Subscription tasks that are run on Backgrounder processes.
- TS Content — High-level, summarized data for each view, workbook, and Published Data Source on Tableau Server.
- TS Data Connections — Maps both workbooks and published data sources to their underlying data connections. Useful for answering questions about what workbooks connect to what data source, which then connects to what database(s)?
- TS Events — Master audit data source showing events happening on Tableau Server—users signing in, accessing views, publishing content, etc.
- TS Users — Aggregated information on user activity.
- TS Web Requests —Requests made through the Tableau Server web server component. Useful for understanding user interaction with vizzes, as well as performance monitoring.

Tableau Cloud Site Administrators will create the Admin Insights project and data sources. Initially, this project and content is visible to site admins only. Tableau Cloud Site Administrators should consider who will benefit from this data and grant permissions to it accordingly. Tableau Cloud Admin Insights data sources are shown below:

- TS Events — Master audit data source showing events—users signing in, accessing views, publishing content, etc.
- TS Users — Aggregated information on user activity.

Tableau Accelerators

Tableau Accelerators are pre-built dashboards designed to help you get a jumpstart on your data analysis. Our collection of Accelerators includes two dashboards that administrators can use to improve dashboard load times at scale; read [more on the Tableau blog](#).

Access the complete set of Accelerators on the [Tableau Exchange](#) and in Tableau Desktop. Additionally, select Accelerators are available to use when you create a workbook in Tableau Cloud.

Secure On-Prem Servers

To prevent users with publish/explore permissions from connecting to Tableau Server resources that they shouldn't have access to, complete the following steps to configure and secure your on-prem servers.

1. Create a PostgreSQL user account.
2. Name it: tbladminviews
3. Select the least privileges for Admin Views.
4. Change the Admin Views workbook templates to use tbladminviews instead of tblwgadmin.
5. Add connection IP policy to deny private (non-routable) IP addresses:

- a. Change connection IP default rule to Allow

```
tsm configuration set -k ConnectionIPDefaultRule=ALLOW
```

- b. Deny private (not-routable) IP addresses

```
tsm configuration set -k ConnectionIPDenyRanges=127.0.0.1,192.168.0.0-192.168.255.255,172.16.0.0-172.31.255.255,10.0.0.0-10.255.255.255
```

Troubleshooting

Tableau Server

For troubleshooting ([Windows](#) | [Linux](#)), and more detailed analysis of server processes, use Tableau Server Logs. If you need to [open a support case](#), you will need to submit the log files. Tableau Support will use log files to diagnose issues. To generate a log file snapshot and upload to Tableau Support, follow these instructions ([Windows](#) | [Linux](#)).

Beginning with 2019.3 and licensed as part of the [Tableau Advanced Management](#), the [Resource Monitoring Tool](#) provides a comprehensive look at the health of Tableau Server using a web user interface for all of its features. The [Resource Monitoring Tools Agent](#) runs on each of the nodes in your Tableau cluster to monitor their hardware utilization, performance, and activity, which are collated by the [Resource Monitoring Tool Master Server](#). This includes [Tableau log files](#) in near real time and send messages to the master server for processing and reporting, logging [slow views](#) for specific users, and tracing down to the session level.

Alternatively, [Logshark](#), a free open source tool, is a command line utility that you run against Tableau Server logs to generate a set of workbooks that provide insights into system performance, content usage, and error conditions. You should use Logshark to visualize, investigate, and solve issues with Tableau. Some common use cases for Logshark include:

- Troubleshooting issue(s) that are recorded in the logs.
- Analyzing system metrics from log data.
- Regularly validating Tableau Server application behavior against historical data when taking a new build or making a system change.

BEST PRACTICE RECOMMENDATION:

[Logshark](#) uses the entire set of Tableau zip log files that you generate. It can be either a just one day or several days of logs. There are many Logshark plugins, which will correspond to a set of log files, to generate pre-built Tableau Workbooks automatically.

For viewing individual log files ([Windows](#) | [Linux](#)), [Tableau Log Viewer](#) is cross-platform, free open source tool with a simple interface that displays Tableau log files in a columnar layout.

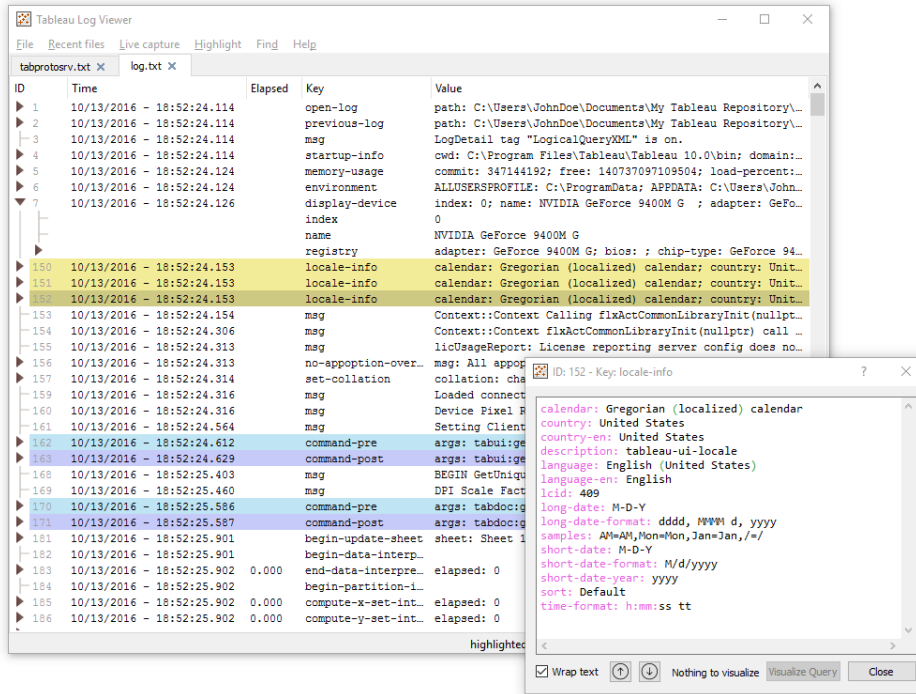


Tableau Cloud

Tableau Cloud Site Administrators should subscribe to [Tableau Trust](#) updates to get email, text, and Atom Feed or RSS Feed notifications when Tableau creates, updates or resolves an incident. When having an issue, check [Tableau Trust](#) to see if there are any active incidents first. If you are still experiencing problems, you should open a support case.

Tableau Maintenance

As the use of analytics grows across your organization, Tableau will become mission-critical for data-driven business decisions. Regular maintenance activities will keep your Tableau deployment running in top condition. Monitoring data will be the driver behind many maintenance decisions.

You will operationalize change management processes to support the increased use of analytics, including performance tuning, load testing, and capacity planning for Tableau Server. For both Tableau Server and Tableau Cloud, upgrades will need to be planned and executed alongside the communications, education, and support plans to move to a new version of Tableau.

Tableau Server

Tableau Server Administrators will check the status of the server, analyze and monitor server activity, manage scheduled tasks, and perform other maintenance activities. Tableau Server maintenance activities are listed in the table below:

Task	Description	With	Frequency
Active Directory Synchronization	Synchronizes Active Directory groups	Tableau Server Settings	Daily
Backup Production Environment	Creates a copy of content and settings in location outside of Tableau Server cluster, retained for last seven days	TSM CLI	Daily
Restore Production to Test Environment	Puts test environment in current state of production environment	TSM CLI	Prior to load testing, testing an upgrade, or participation in beta program
Database Maintenance/ Log File Cleanup	Remove and archive Tableau Server log files, temporary files, and rows from the table http_requests in the Tableau Server PostgreSQL	TSM CLI	Monthly

Task	Description	With	Frequency
	database		
Load Testing/ Capacity Planning	Understand your Tableau Server's capacity with respect to your environment, data, workload, and usage profile	TabJolt (Windows only)	Quarterly
Resource Management	Archive stale content that has not been accessed in 180 days	Admin View	Two to four times per year prior to upgrade
Upgrades	Process to evaluate new releases and plan/execute the upgrade	TSM CLI	Agreed-upon cadence among sponsors and project team

Tableau Cloud

One of the benefits of Tableau Cloud is that it is maintained by Tableau because it is a SaaS analytics platform. As a result, minimal maintenance activities are needed:

Task	Description	With	Frequency
Stale Content Management	Archive stale content that has not been accessed in 180 days	Admin View	Two to four times per year
Client Upgrades	Process to evaluate new releases and plan/execute the client upgrade	Client testing	On release schedule

User Provisioning and Group Synchronization

Tableau Server

If you are using Active Directory authentication, you should synchronize all Active Directory groups on a regular schedule using the General tab of the Settings page for the server. If you run Tableau Server on Linux, external directory communication is configured and managed with an LDAP identity store. In the context of user and group synchronization, Tableau Server configured with LDAP identity store is equivalent to Active Directory. Active Directory synchronization features in Tableau Server function seamlessly with properly configured LDAP directory solutions ([Windows](#) | [Linux](#)).

Tableau Cloud

You can automate adding or removing users from Tableau Cloud or adding or removing members from groups using your identity provider (IdP). Tableau Cloud IdP user management uses the System for Cross-domain Identity Management (SCIM) standard, which is an open standard for automating the exchange of user identity information. Okta and OneLogin IdPs are currently supported for SCIM. For more information, see [Automate User Provisioning and Group Synchronization through an External Identity Provider](#).

Back-up and Restore

Note: This topic applies to Tableau Server only.

A Tableau Server administrator should perform daily backups of Tableau Server and its data. Taking these steps can help ensure that Tableau Server runs with minimum loss. You will use the Tableau Services Manager (TSM) command line tool to back up and restore Tableau data, including Tableau Server's own PostgreSQL database, which stores workbook and user metadata, data extract files, server configuration data, and log files ([Windows](#) | [Linux](#)). As of 2018.2, both Windows and Linux versions of Tableau Server use TSM.

Database Maintenance

Note: This topic applies to Tableau Server only.

Database maintenance creates free space on the Tableau Server deployment by deleting old files, including log files, temp files, and rows from the `http_requests` table. If you are running Tableau Server on a distributed deployment, run the [tsm maintenance cleanup command](#) on the node that is running the TSM Controller process. By default, the controller is on the initial node in the cluster ([Windows](#) | [Linux](#)).

Note: If you need historical data in `http_requests` for audit analysis, ETL the data from the `http_requests` table to another database prior to executing the cleanup commands. If cleanup commands are part of your backup script, data in the `http_requests` table is truncated.

Load Testing

Note: This topic applies to Tableau Server only.

Load testing helps you understand your Tableau Server's capacity with respect to your unique environment, data, workload, and usage profile. Because data, workload, and usage will change as new content is authored, new users are onboarded, and the use of analytics increases, load testing should be conducted two to four times a year in conjunction with upgrades and server scale-up or scale-out expansions.

Created by Tableau, [TabJolt](#) is a point-and-run load and performance testing utility specifically designed for Tableau Server. It helps you understand how Tableau Server scales with increasing workloads to inform your capacity needs. TabJolt automates user-specified loads for any duration, while eliminating the need for script development and script maintenance, which is often required with other load testing solutions. With increasing user loads, Tableau Server scales nearly linearly with load by adding more nodes to the cluster for Windows and Linux.

Load testing best practices are listed below:

- Load testing should be conducted with TabJolt on an identical test environment with content restored from the production environment. This is not only from a hardware and Tableau Server topology perspective but also in terms of data volume.

- Select representative content from your top-viewed workbooks. Often the cause of scalability and performance issues can be workbooks being not authored with best practices in mind. If a single-user test on your workbooks shows a very slow response time, then you should optimize those workbooks before you begin a load-testing project.
- During testing, increase the workload to 75-85% CPU utilization and < 2% error rate.
- Start with the default process configuration determined by Tableau Server's architecture-aware installer and scale up or out as needed when the threshold is met and sustained.
- In most cases, increasing process counts above the defaults does not improve performance, unless enough hardware resources are available.
- It is always good to know the breaking point of the Server on the level of how many users/requests along with volume of data it can handle.

Developing a test plan:

- Choose representative workbooks.
- Model the expected usage.
- Think about peak usage.
- Run for at least ten minutes.
- Include think time.
- Stop other work on the server.

Capacity Planning

Note: This topic applies to Tableau Server only.

To ensure optimal Tableau Server performance and sufficient capacity to handle increased workloads, you must plan for growth. Capacity planning allows you to scale your infrastructure with the increased use of analytics and rapid adoption across your organization by ensuring sufficient headroom is maintained and reducing the likelihood of resource contention and conflicts over shared resources. Performance data, user onboarding schedules, and load testing results are used to determine future server sizing and the capacity plan.

Factors that can influence capacity planning:

- A newly released set of data sources coupled with a dashboard that draws the attention of the entire company.

- Increasing skills and use of analytics that become ingrained in the day-to-day operations of the company.
- New features released in the platform, which can increase user interactivity overall.
- Change of underlying data strategy powering these dashboards, either in terms of volume, complexity, change in database technology, user security etc.

To complete the table below, you should aggregate the count of users from the [Tableau Users](#) on page 56 tab in the [Tableau Blueprint Planner](#).

Year 1* Year 2 Year 3

Total Users

Nodes

Total Cores

Note: Depending on the number of users and onboarding rate, you may consider 6-month, quarterly, or monthly intervals.

Resource Management

Note: This topic applies to Tableau Server only.

While site administrators should be maintaining fresh and relevant content on their sites as outlined in [Measurement of Tableau User Engagement and Adoption](#) on page 233, Server Administrators have oversight of the entire server and how the server's resources are utilized as outlined in [Tableau Monitoring](#) on page 183. The standards you define should be documented and published on the [Tableau Enablement Intranet](#) on page 277, which is explained in [Tableau Communications](#) on page 277. Remember that system performance is a shared responsibility.

Stale Content Audit

If content is published with a scheduled refresh but not viewed, it is consuming system resources and potentially making it harder for users to locate more relevant content in Tableau Server. The unused content will also add to backup and restore times in Tableau Server. Stale content should be removed two to four times per year. For more information, see [Stale Content](#).

Size Audit

Monitor content by establishing policies around workbooks and data source size. Set [data-driven alerts](#) on the Stats for Space Usage view to identify which workbooks and data sources exceed the expected size limit, using the version of the default admin views workbook you downloaded and published with extracted data sources. For example, if you set a standard that extract sizes should be less than 1 GB, then alert for anything larger.

Load Time Audit

Monitor content by establishing policies around workbook load times. Set [data-driven alerts](#) on long view load times using the version of the default admin views workbook you downloaded and published with extracted data sources. For workbooks with long-load times, use [Tableau Desktop's](#) or [Tableau Server's](#) Performance Recorder to dive deeper into the events and timing.

Upgrades

As part of defining your organization's [Analytics Strategy on page 27](#), the cross-functional project team established the guiding principles for upgrades with the [Tableau Upgrade Planning and Process Checklist on page 58](#). The initial decisions about upgrade frequency, version selection, and version compatibility define when and how upgrades are performed. When these areas are addressed early, administrators can better manage users' expectations, rather than having to react to business demands for new features and functionality. In addition, the communications, education, and support plans should be created by the project team in preparation of the software upgrade process outlined in this topic.

Version Compatibility

Tableau Server, Tableau Cloud, Tableau Desktop, and Tableau Prep Builder are updated regularly. Releases may introduce new features that can have architectural changes to the platform. Due to these changes, upgrades require comprehensive testing in your test environment to mitigate post-upgrade issues. For each upgrade, you should evaluate version compatibility by reviewing the links below:

- [Version Compatibility Between Tableau Desktop and Tableau Server](#)
- [Workbook Version Compatibility](#)

- [Version Compatibility with Tableau Prep](#)
- [Version Compatibility with Tableau Cloud](#)

Communicating the Upgrade

To notify users of the pending upgrade, Tableau Server administrators should use Tableau Server a [sign in message](#) and/or a [welcome banner message](#) to help communicate the downtime window. The sign in message is found in Server Settings > General as shown below:

Sign In Customization

Include an optional note and URL that users see on the Tableau Server sign in page

Note

Up to 120 characters

URL(optional)

The welcome banner is found in Server Settings > Customization as shown below:

General Licenses Extensions **Customization**
Revert Save

Welcome Banner

Manage the welcome banner. All users can see welcome information on the Home page.

Show Tableau banner by default

Add a custom message for all server users

Add your text and links in the box below. To add a hyperlink, highlight the text and enter the URL.

Your Tableau site—where analytics and your organization meet

Harness your data. Discover opportunities. Elevate your insights.

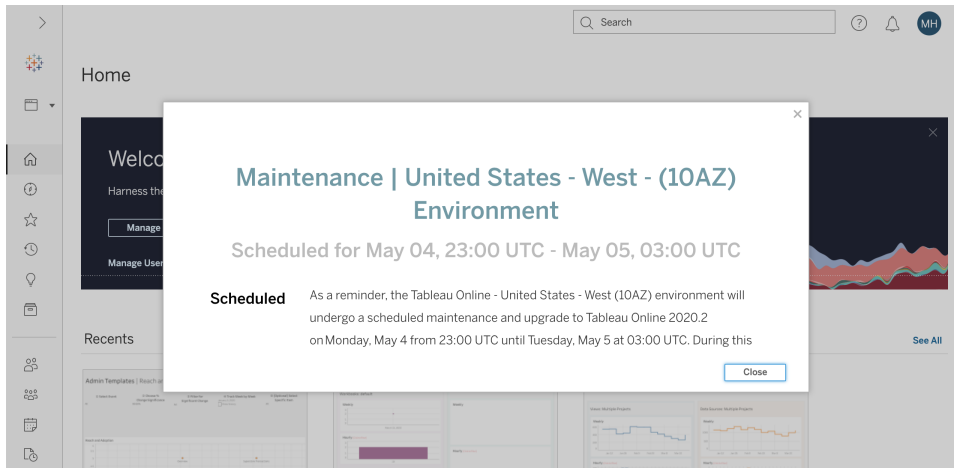
[Start Exploring](#)

[Create Workbook](#) | [Upload Workbook](#)

Server Downtime: Friday, May 1 at 11PM through Sunday, May 3 9AM. Tableau will be upgraded to 2020.1. Visit the [Enablement Intranet](#) for more details.

150 / 240 characters. Limit to one paragraph break.

Because Tableau Cloud is a fully-hosted solution, Tableau maintains it. The maintenance window for Tableau Cloud is communicated in advance through a pop-up message after sign in, as shown below:



Software Upgrade Process

For Tableau Server, the software upgrade process will be performed by the Systems Administrator and Tableau Server Administrator roles, who will upgrade the server environments beginning with the test environment. Once validated in the test environment, they will schedule the production environment upgrade and, if applicable, the disaster recovery environment upgrade. The Resource Monitoring Tool master server and agents should also be upgraded too, if deployed.

Beginning with version 2018.2, Tableau Server on Windows is available with [Tableau Services Manager \(TSM\)](#), beginning with version 2018.2 for Tableau Server on Windows and version 2018.1 for Tableau Server on Linux. The Tableau Server upgrade process has changed with the introduction of TSM. TSM is the web-based server configuration and management utility that replaces the Server Configuration utility and the `tabadmin` command line utility. TSM is used to manage installation and configuration of Tableau Server.

When you upgrade from a pre-TSM version of Tableau Server (2018.1 or earlier) to a version running with TSM, you need to go through some special upgrade steps. These are required only for the pre-TSM to TSM upgrade. Pre-TSM versions of Tableau Server on Windows are versions older than 2018.2. Examples of pre-TSM versions are 9.3, 10.5, and 2018.1. For instructions on how to determine your version of Tableau Server, see [View Server Version](#).

The Desktop Administrator and Mobile Administrator roles will be responsible for packaging and updating Tableau Desktop, Tableau Prep Builder, and Tableau Mobile, which apply to both Tableau Server and Tableau Cloud deployments. Review and upgrade other applications based on your installations, such as `tabcmd`, Tableau Bridge for Tableau Cloud, and the Content Migration Tool.

For every upgrade, you should evaluate the following areas:

- Understand how Tableau is used: how an upgrade may affect existing use cases and enable new use cases.
- Assess the current deployment using monitoring and measurement data: topology, content, users.
- Compare with future state: sources of data, configuration changes, capacity vs. planned user onboarding schedule.
- Inventory existing software versions: client machines, drivers, mobile devices.
- Identify programmatic dependencies: embedded analytics, API-related, multi-instance deployments, client software versions and compatibility.
- Schedule a retrospective to understand what worked and what didn't, including identifying opportunities for improvement.

Before you upgrade Tableau Server ([Windows](#) | [Linux](#)), you should review and complete the Upgrade Process Checklist below. It is included in the [Tableau Blueprint Planner](#), so that it can be customized for your requirements. Tableau Cloud customers should complete the first two tasks in Research the Upgrade, then skip to the tasks labeled **Perform the Client Upgrades on page 214**. Additional input from the Enterprise Architect, Database Administrator, Security Administrator, and Network Administrator roles may be needed if changes are required in their corresponding area of expertise.

Note: Specific tasks related to pre-TSM to TSM version upgrades are designated with an asterisk in the tables below.

Research the Upgrade	Yes No N/A
Review Release Notes: Tableau Server Tableau Cloud	
What's New and Changed in Tableau Server What's New in Tableau Cloud	
Upgrade from Tableau Server 2018.1 or earlier to TSM Linux Windows Tableau Community Forum Post	
Comparing Functionality of tabadmin to TSM*	

Research the Upgrade

Yes No N/A

Validate sufficient capacity to support workload

Install on existing hardware

[Migrate to New Hardware](#)

[Desktop and Server Compatibility](#)

Prepare for the Server Upgrade

Yes No N/A

Review and validate documented settings in Tableau Server Architecture & Configuration Design Document

Customizations

SMTP configuration

SSL configuration and certificates

SAML configuration, certificates, and IdP metadata files

Kerberos configuration

OpenID configuration

Addition node(s) configuration

Quantify projects, workbooks, views, data sources

Quantify users and groups

[Download setup files](#) for the new Tableau Server version

[Back up Tableau Server data](#)

Check your product maintenance status

Test the Server Upgrade

Yes No N/A

[Prepare a test environment](#)

Test the Server Upgrade	Yes	No	N/A
Upgrade the test environment			
Confirm Tableau Server functionality			
Server processes			
User access			
Publishing workbooks and data sources			
View published workbooks			
Subscriptions and extract refreshes			
Permissions			
Command-line utilities and APIs			
Performance and user acceptance testing			
Performance Resources			
Test Workbook Performance			
Test new features			
Communicate the planned upgrade window			

Note: Specific tasks related to pre-TSM to TSM version upgrades are designated with an asterisk in the tables below.

Perform the Server Upgrade	Yes	No	N/A
Communicate the pending upgrade			
Disable subscriptions and scheduling			
Create a pre-upgrade backup of Tableau Server data. Reference Back up Tableau Server data for assistance.			
Uninstall existing pre-TSM version of Tableau Server and save tsbak file to another location*			

Perform the Server Upgrade

Yes No N/A

Upgrade Tableau Server

Install initial node

Install other nodes in cluster

Run the upgrade script to complete the installation

Login to TSM and start Tableau Server

Restore gathered files*

Validate the upgrade

Verify status of Tableau Server processes

Verify Tableau Server settings

Enable subscriptions and scheduling

Modify Tableau Server processes (if needed)

Review User access

Verify publishing workbooks and data sources

View published workbooks

Review Permissions

Verify Command-line utilities and APIs

Login to Tableau Server

Verify count of projects, workbooks, views, data sources

Verify count of users and groups

Verify database connectivity

Execute backup script

Upgrade Resource Monitoring Tool master server and agents

Perform the Server Upgrade**Yes No N/A**

Communicate the successful upgrade

Perform the Client Upgrades**Yes No N/A**

Communicate the client software to be upgraded (Tableau Desktop, Tableau Prep Builder, tabcmd, Content Migration Tool, Tableau Mobile, Tableau Bridge)

Upgrade Tableau Desktop and Tableau Prep Builder

Upgrade tabcmd

Upgrade Content Migration Tool

Upgrade Tableau Mobile (auto update, publish to MDM)

Upgrade Tableau Bridge (for Tableau Cloud)

Tableau Education

People who realize the full potential of analytical insights can do powerful things with their data. But having a platform like Tableau and access to data isn't enough; organizations need to assure that their employees are prepared to use the tools at their disposal effectively. Additionally, businesses need accountability systems in place to make sure that technology is being adopted and used.

No one-size-fits-all model can successfully train and enable employees with a vast diversity of skills and backgrounds. Organizations need scalable, thoughtful plans to train and enable users who support every area of their Tableau deployments. Without these plans, analytics programs of any size risk failure.

From acknowledging the importance of data to adapting to modern analytics standards around presentation, distribution, and complexity, project team members must develop an education plan to raise the “analytical IQ” across their departments and teams. In addition to Tableau-specific skills, users need an understanding of the company-specific processes for working with data and comfort with technologies that help them to develop data-related skills.

This topic outlines our recommended approach to educating and enabling people throughout the enterprise to get full value out of your data in Tableau.

Data Literacy

Every day, your people use data to make better decisions in their personal lives—from what route to take somewhere, to monitoring diet and exercise, and managing finances. Think about that: Almost everyone uses some kind of data-driven tool to measure their progress or modify behaviors for improved outcomes. So why should it be any different at work, especially when the amount of data collected has never been greater?

To become a more data-driven organization, you will quickly realize that it requires more than deploying software and considering the work complete. Even with the right data and analytics technology, it's not easy to make data-driven decision making a default behavior for everyone across your organization.

The fundamental skill people need is data literacy—defined as the ability to explore, understand, and communicate with data. By prioritizing data literacy as the baseline, you can empower your people with the new language of business, just as humans have used symbols, words, and language throughout history.

Data literacy is not only a skill for data scientists and analysts; it should be viewed as the prerequisite for additional skills which are developed on the path to proficiency. Everyone, regardless of their position or department, must know and embrace the language of data to help their organization tackle its difficult problems (e.g., new or developing market trends, customer activity and needs, or unexpected crises). This means putting tools and processes in place that people will actually use, teaching them new skills, encouraging new behaviors and continuous learning, and recognizing when there are data-related wins.

Your users will be vast and varied in their data skills, as well as the skills that need to be developed. To assist your organization with establishing data literacy as a fundamental skill, [Tableau's Data Literacy for All free eLearning](#) offers five hours of practical training and resources to help everyone. The following topics are covered within seven on-demand eLearning modules:

- Foundational data literacy concepts
- Recognizing well-structured data
- Exploring variables and field types
- Exploring aggregation and granularity
- Understanding distributions
- Understanding variation for wise comparisons
- Using correlation and regression to examine relationships

While modules can be completed in any order, employers should ensure completion of all modules by manually collecting the certificate of completion. Employees can access their certificate of completion as a PDF, download it immediately after finishing the seventh module, and provide it to their employer. Organizations may also consider holding competitive team or individual challenges to encourage engagement and training completion as they collect certificates. For organizations with varied data skill levels, this is a simple, easy way to also test basic data literacy, so you have a baseline to build from.

Having and developing a community will also go a long way in nurturing a more data literate workforce. Community spaces like a regular user group or an internal discussion forum offer your employees a place where they can explore and communicate with data using real-world scenarios or company-specific data challenges. In these venues, it's easier to practice these evolving skills, and identify knowledge gaps or cultural behaviors that may hinder individual or collective progress—obstacles that aren't always captured when people just complete a training.

Once your users have established the baseline skills by completing [Tableau's Data Literacy for All free eLearning](#), continue to promote educational development with the prescriptive Tableau

learning paths. For more information, see [Skills by Tableau Education Role](#) below. For smaller deployments, see [Skills by Tableau License Type](#) on page 223.

Skills by Tableau Education Role

The first step in educating your users is to understand the skills they will need in order to be successful in their roles. Successful data-driven organizations are supported by a wide variety of people, and needed skills range from successfully viewing and interacting with data to building high-availability into Tableau Server deployments.

The [Executive Advocacy and Project Team](#) on page 69 topic classifies users based on roles they will play in building your organization's analytics strategy. Classifying users based on needed skills goes one step deeper. As you dig in, you will notice similarities among these roles, explained below.

Employees need to learn the Tableau skills unique to their roles and responsibilities within an organization. We have categorized each unique set of Tableau skills as an Education Role. Education Roles focus on the analytical and Tableau skills that users need to fulfill their day-to-day job responsibilities. In contrast, [Tableau Project Team Roles and Responsibilities](#) on page 72 identify the deployment-related tasks and responsibilities for each project team member. Like Project Roles, Education Roles may not exactly match users organizational titles, but you can easily identify them by understanding the responsibilities of each role.

We identified twelve Education Roles that map to prescriptive [Learning Paths](#) that will educate employees in the skills needed to contribute to the growth of a data-driven organization. We recommend that you review the education needs of different organizational roles even if you decide to self-curate education resources or to consume training courses individually.

Use the Education Role Mapping tab in the [Tableau Blueprint Planner](#) to begin building an education strategy by mapping job titles within your organization to Education Roles.

Enable a data culture in your organization

These roles establish cultural and technical standards to align every Tableau user to the analytics goals of your organization.

	Culture				Data			Role Badge
	Tableau Basics	Blueprint	Data Culture	Governance	Data Analysis	Data Prep	Data Stewardship	
Executive Sponsor	○	○	○					✔
Community Leader	○	○	○					✔
Data Steward	○			○	○	○	○	✔

Executive Sponsor

Executive Sponsors are responsible for driving the decisions and strategies that enable their organization's continued growth and success. They understand market pressures, what it takes to stay competitive, and how to lead their organization forward. These leaders recognize, embrace, and promote the importance of implementing a data-driven culture to gain competitive advantage and understand the power of Tableau to achieve that goal. License types vary for Executive Sponsors based on where they are most active in their business. Their responsibilities include:

- Communicate and sell the vision for modern analytics across the organization. Represent the interests of their respective departments to establish budget and funding.
- Align the use of analytics with strategic initiatives that drive organizational transformation.
- Approve Tableau Governance processes, policies, guidelines, roles, and responsibilities for managing their organization's data in compliance with business and/or regulatory requirements identified by the project team.
- Set the example of using facts over intuition by placing data at the center of every conversation in department meetings as a visible and vocal user of the platform.

Community Leader

Community Leaders are responsible for coordinating efforts related to user enablement around communications, engagement, and support. Most Community Leaders also fall into a role with heavy product usage, and will require a Creator subscription to understand how others are using Tableau. Their responsibilities include:

- Facilitate user to user connections within the organization
- Coordinate engagement events for users within the organization
- Promote support resources for users within the organization
- Evangelize the use of analytics

Data Steward

Data Stewards understand the business domain and the interaction of business processes with analytics. Data Stewards ensure there are documented procedures and guidelines for data access and use and work with Database Administrators and/or Data Engineers to plan and execute an enterprise-wide data governance, control and compliance policy. Within Tableau, they work to curate and manage certified data sources with set user permissions in accordance with enterprise governance policies. Data Stewards likely have a Creator license and their responsibilities include:

- Ensure the accuracy, completeness, privacy, and security of operational data.
- Ensure that the right data is available to the right people in the organization.
- Understand the types of data the business needs.

Provide insights and develop visualization solutions

These roles use the capabilities of the Tableau platform to consume & create business solutions that range from ad-hoc visualizations to embedded analytics.

	Tableau Basics	Data Analysis	Visual Best Practices	Deep Insights	Data Prep	Data Science		Solutions		Role Badge
						Statistical Capabilities	Machine Learning	Embedded Analytics	Optimization & Integration	
Consumer	○									✓
Author	○	○								✓
Designer	○	○	○							✓
Analyst	○	○	○	○						✓
Data Scientist	○	○	○	○	○	○	○			✓
Developer	○							○	○	✓

Consumer

Consumers use data to make more informed decisions for their lines of business. They can range from administrative assistants to C-suite executives, but they share a goal of making better, more informed business decisions based on dashboards and reports others in their organization produce. Consumers likely have a Viewer license and their responsibilities include:

- View reports and dashboards created by others and potentially serve as primary stakeholders of these dashboards.
- Use data to make decisions day-to-day job functions, keep informed of progress toward goals, and track team or company metrics.
- Stay knowledgeable in their subject areas even if they are not expert data analysts.

Author

Authors have a strong understanding of their market and business objectives, and they recognize the importance of making data-driven decisions. They leverage their foundational Tableau skills to make smarter business decisions more quickly by digging into their available data sources to create visualizations and dashboards mostly for their own consumption. Authors likely have a Creator license, but may also author on the web with an Explorer license. Their responsibilities include:

- Create and use existing data sources and create views and dashboards to provide actionable insights in Tableau Desktop.
- Perform basic analysis for personal use rather than for consumption by others, to increase personal job performance.
- Demonstrate knowledge of the area being analyzed.

Designer

Designers create visualizations and dashboards that help stakeholders across their organization absorb information quickly and easily. They leverage Tableau to deliver beautiful, functional, and impactful dashboards. They draw on their appreciation of the art of visual design as a clear communication tool and on their understanding of the impact that clear and engaging visualizations can have on both internal and external audiences. Designers likely have a Creator license and their responsibilities include:

- Demonstrate passion about visualization layout, color, appearance, and functionality.
- Ensure that their visualizations convey information accurately and efficiently to their audience.
- Create appealing dashboards that make it easy for users to explore data and gain insights.

Analyst

Analysts are responsible for supporting their lines of business to deliver valuable insights from data. Analysts work with complex data sources, use advanced calculations to customize data, and use advanced features (parameters, sets, filters, and forecasting) to build a range of charts and to analyze a variety of data types. Analysts perform ad-hoc analysis to help explore new data questions, produce well-designed interactive dashboards that present data accurately, and create and share data insights within their organizations for the purpose of guiding business decisions and outcomes. Analysts likely have a Creator license and their responsibilities include:

- Create reports and dashboards for others in the organization to consume or iterate on.
- Perform ad-hoc exploration of data to highlight business opportunities.
- Conduct meaningful data analysis to inform business decisions.

Data Scientist

Data Scientists are experts at deriving valuable insights for large and varied data sets. They are adept at tackling big data, know how to apply advanced analytic capabilities to answer business questions, are often domain experts, and work collaboratively across the business and IT to deliver ROI from data. They can reduce data cleansing and preparation time in Tableau Prep Builder, use Tableau Desktop for exploratory analysis, and develop final dashboards to support and clearly present project findings. Data Scientists likely have a Creator license and their responsibilities include:

- Build and deploy end-to-end solutions leveraging machine learning and advanced analytics.
- Build and test models in R, Python, or other coding languages, perform simulations, and tune models for enterprise production.
- Work with stakeholders throughout the organization to identify opportunities for leveraging company data to drive business solutions.

Developer

Developers translate the needs of the business into the software tools, applications, and automated processes that keep their organizations lean, smart, and efficient. They leverage Tableau to create new data products, embed visualizations and dashboards into current solutions, improve analysis processes, and integrate organizational insights into other external platforms and portals. Developers likely have a Creator license and their responsibilities:

- Embed and integrate Tableau vizs into internal and external web applications (e.g. Salesforce).
- Script automation tasks.
- Build web data connections to bring in data from sources without native connectors in Tableau.
- Create custom data extracts.
- Create Dashboard Extension add-ins for customized workflows in Tableau.

Deploy and manage Tableau

These roles plan scalable deployments of Tableau Server or Tableau Cloud and once in production, ensure that users can access what they need when they need it.

	Tableau Basics	Governance	Administration			Deployment		Role Badge
			End User Experience	Security	Monitoring & Auditing	Distributed Environments	High Availability	
Site Admin	<input type="radio"/>	<input type="radio"/>	<input type="radio"/>	<input type="radio"/>	<input type="radio"/>			<input checked="" type="checkbox"/>
Server Admin	<input type="radio"/>	<input type="radio"/>	<input type="radio"/>	<input type="radio"/>	<input type="radio"/>			<input checked="" type="checkbox"/>
Server Architect	<input type="radio"/>					<input type="radio"/>	<input type="radio"/>	<input checked="" type="checkbox"/>

Site Administrator

Site Administrators manage, monitor, and maintain sites on Tableau Server or Tableau Cloud. They manage site organization, content publishing, groups, users, and permissions. Through their monitoring efforts, they know the latest details on site utilization, adoption, performance, and compliance. Site Administrators are key to the adoption of Tableau Server or Tableau Cloud in their organizations. Site Administrators have a Creator license and their responsibilities include:

- Create and manage site users and groups.
- Create projects to organize site content.
- Assign content permissions to users and groups.
- Monitor site metrics such as content usage, success of extract refresh tasks, and user activity.
- Troubleshoot user issues with a site.

Server Administrator

Server Administrators ensure that their installation of Tableau Server runs smoothly. Key elements include securing the server, managing licenses, managing users, monitoring and troubleshooting server issues, and performing server maintenance. Server Administrators work tirelessly to ensure that Tableau Server is not only operational but meets the ongoing needs of the enterprise. Server Administrators have a Creator license and their responsibilities include:

- Install and configure Tableau Server.
- Perform server maintenance (e.g., backups, updates).
- Monitor server performance and usage.
- Manage all sites, users, groups, and content on Tableau Server.
- Create sites.

Server Architect

Server Architects plan Tableau Server deployments and ensure their success. Key success factors include integrating the deployment with preferred authentication options, monitoring server, and scaling server overtime to meet enterprise demand. Once implementation is complete, server architects maintain the deployment and help to investigate and resolve server issues. Their responsibilities include:

- Plan enterprise server deployments.
- Configure server authentication options.
- Monitor, maintain, and scale server deployments to satisfy business requirements.
- Automate server monitoring and maintenance tasks.
- Investigate and resolve server issues.

Skills by Tableau License Type

License type defines the features and functionality available when using Tableau products. In large deployments, learning paths defined in [Skills by Tableau Education Role on page 217](#) are a best practice. In smaller deployments, however, users may act in many different organizational roles, and determining skills needed by license type may be sufficient.

We list education resources aligned to Tableau licenses here. Free resources supplement the formal training that helps to build a holistic, foundational understanding of the platform. Organizations that wish to collate free resources to build their own training curriculum may do so; however, we recommend comparing the resources required to develop and maintain an internal education program versus using Tableau Education. In addition to being actively managed and consistently updated by Tableau, Tableau Education classes prepare users for Tableau [product certification exams](#).

Tableau Creator Skills

Users with Tableau Creator licenses have access to the entire Tableau platform to analyze data and to build content for themselves and their organizations. These users perform tasks that range from basic analysis to using Tableau's advanced functionality to inform business decisions.

Resources for Tableau Creators include:

- Free [Data Literacy for All](#)
- [eLearning for the Creator](#)
- [Desktop I Classroom Course](#)

- [Desktop II Classroom Course](#)
- [Desktop III Classroom Course](#)
- [Prep Classroom Course](#)
- [Visual Analytics Classroom Course](#)

Additional ancillary skills can be beneficial. For example, the following general competencies required to be a Tableau Creator can be summarized as:

- General data knowledge — How to connect to and prepare data, general data structures, joins, and basic SQL.
- Analytics best practices — Generating data questions, data visualization, data storytelling.
- Business knowledge — Familiarity with the business challenges and metrics monitored by business leaders.
- Design fundamentals — Layout/design of dashboards, infographics, and other graphical documents.

Most Server Administrators and Site Administrators also have Creator licenses. They are responsible for installing, administering and maintaining servers and server sites used at their organizations. They are responsible for security, performance, governance, and scalability for their users.

Resources for Tableau Site or Server Administrators include:

- [eLearning for the Creator](#)
- [Server Administration Classroom Course](#)
- [Server Architect Classroom Course](#)

Other ancillary knowledge needed for Server Administrators, which are defined in more detail in [Tableau Deployment](#):

- Scripting for automation
- Command line interfaces and APIs
- Server sizing and topology
- Network infrastructure and protocols

Tableau Explorer Skills

Users with Tableau Explorer licenses author simple visualizations through the web, navigate Tableau Server or Tableau Cloud environments, and understand the principles for creating effective views with data. Resources for Tableau Explorers include:

- Free [Data Literacy for All](#)
- [eLearning for the Explorer](#)

Additional ancillary skills can be beneficial for Explorers, such as:

- Analytics best practices — Generating data questions, data visualization, data storytelling
- Business knowledge — Familiarity with the business challenges and metrics monitored by business leaders
- Design fundamentals — Layout/design of dashboards, infographics, and other graphical documents

Tableau Viewer Skills

Users with Tableau Viewer licenses navigate Tableau Server or Tableau Cloud environments, read various chart types, and know how to interact with visualizations.

Resources for Tableau Viewers include:

- Free [Data Literacy for All](#)
- Free [Consumer Learning Path](#)
- Free [Executive Sponsor Learning Path](#)

Developing a Tableau Education Plan

An education plan outlines how your employees will gain the skills needed to be successful in their roles. Before considering enablement options, it is important to identify who your users are and what skills they need to fulfill their specific responsibilities to make your Tableau deployment successful. Find more information about defining your users in [Tableau Education Role Mapping on page 53](#).

Education is an ongoing process, and users need readily available tools to stay up to date on the latest product or feature releases. A well thought out plan streamlines skill development for existing and new users. As you consider enablement options, think about the following:

- **Who are your users and how many are in each role?** This information can be aggregated from the [Tableau Users on page 56](#) in the [Tableau Blueprint Planner](#).
- **Where are they located?** Users can be in a single location or spread across multiple locations.
- **How quickly do they need to get up and running?** Consider organizational-level initiatives or goals that are impacted by the success of your users.

- **How do they like to learn?** Some learners prefer an immersive classroom experience, while others prefer self-paced learning that accommodates their day-to-day work.

These answers will help you determine which enablement options best fit your users individually and your organization as a whole.

Learning Paths

Role-based learning paths are designed to accelerate user proficiency. Each path is curated by product experts to provide users with the right resources at the right time. Learning paths include self-paced eLearning content, classroom courses, free resources, assessments, and skill badges available through Tableau's eLearning platform. Learning paths guide users in each Education Role to develop the necessary skills while encouraging those with existing analytic skills to accelerate to more advanced levels. For more information, see education products on the [Learning Paths](#) overview.

Learning Paths map to [Skills by Tableau Education Role on page 217](#) and provide clear paths for every role you've identified in your organization. Users may need to complete multiple paths if their responsibilities fall across more than one Education Role.

All Learning Paths are included in the eLearning for the Creator subscription, and a subset (Executive Sponsor, Community Leader and Consumer) are available in the eLearning for the Explorer subscription (some paths include classroom courses at additional cost).

Enable a Data Culture:

- [Executive Sponsor](#) (free)
- [Community Leader](#) (free)
- [Data Steward](#)

Provide insights and develop visualization solutions:

- [Consumer](#) (free)
- [Author](#)
- [Designer](#)
- [Analyst](#)
- [Data Scientist](#)
- [Developer](#)

Deploy and manage an optimized environment:

- [Site Administrator](#)
- [Server Administrator](#)
- [Server Architect](#)

In addition to curated skill building activities, each learning path includes knowledge checks to ensure the concepts and skills learned are being fully absorbed. Each learning path ends with a skills assessment that covers the core concepts from the path. Upon passing the assessment the user is awarded a Skill Badge, which is a digital badge that users can share on social media and with their organizations. A user who does not pass is given a detailed list of lessons to review before attempting the assessment again.

To explore content from each learning path, see [Tableau eLearning samples](#).

Education Resources

Role-based learning paths are the most scalable and consistent way to enable users. However, paid training courses and other resources can also be consumed individually. This allows an organization to add resources to a learning path in order to increase the breadth or depth of a user's skill set, if needed.

- [eLearning](#) – Tableau eLearning is web-based training users can consume at their own pace. Courses are interactive and designed to help users learn how to use Tableau, regardless of skill level. Subscriptions include access to Learning Paths and courses.
- [Classroom Courses](#) – Comprehensive instructor-led training allows users to get up to speed quickly. Available in-person in cities worldwide or virtual, classroom courses are designed to provide a distraction-free learning environment. Organizations with large groups of people requiring training at the same time may save time and money by choosing to have a Tableau trainer lead [classes on-site](#).
- [On-Demand Webinars](#) – This library of webinars acts as a repository for knowledge sharing for everything from Tableau product releases to niche industry topics.

Organizations wishing to curate their own training materials for Tableau users will need to collate Tableau documentation, videos, and other ancillary skill resources for corresponding job functions. Organize these materials into programs that provide recommended coursework with sequential skill and knowledge development.

In addition to Tableau's education resources, add your own organizational context to help users learn how to apply these product skills to their day-to-day job functions, company sources of data, and organizational best practices. Internal programs should have clear goals and deadlines, and users should have adequate time to meet them.

Accountability and Reward Systems

Accountability and reward systems are series of checkpoints and milestones along a user's skill development path. They establish common goals and achievements across an organization to encourage users to stay motivated and engaged in building their skill sets. Education is an ongoing process, and as an organization's deployment grows, users need opportunities for continuous learning and rewards.

Consider these three approaches to validate skills to incorporate into your education plan:

- Role Badges
- Tableau Product Certification
- Skill Belts

Skill Badges

Users earn skill badges by passing low-stakes, multiple-choice skills assessments of core concepts at the end of role-based learning paths as shown in [Skills by Tableau Education Role](#). Skill badges encourage and motivate users to keep learning in order to demonstrate their knowledge of particular roles. Users are not required to complete all the courses in a learning path in order to take the skills assessment, so more advanced users can skip ahead. They will demonstrate that they hold the necessary skills for the role by earning a passing score. Users who do not pass are given recommendations for the eLearning or Classroom courses that will best answer their skill gaps. Because Skill Badges are available to share via a public URL, they also support progress monitoring and measurement at the organizational level. The badges can be incorporated into your organization's LMS system or intranet. Skill Badges and Skills Assessments are accessed through an [eLearning subscription](#).

Certification

[Tableau Product Certifications](#) enable users to prove their expertise and to distinguish themselves. Holding a Tableau Certification demonstrates that a user is able to apply knowledge of Tableau products in a formal setting. These proctored exams are higher stakes than skill badges and skills assessments because they follow industry standards for professional certification programs. Encouraging and supporting certification within your teams shows commitment to their professional development and creates clear, actionable milestones

for individuals to work toward. By building a core group of certified users, you increase their confidence and encourage them to elevate the skill sets of their peers. There are three levels of certification, Specialist, Associate and Professional, available for two products, Desktop and Server.

	<i>Exam Level</i>	<i>By Product</i>
<i>Difficulty increases ↓</i>	Specialist	Tableau Desktop Specialist – tests foundational functionality and product comprehension.
	Professional	Tableau Certified Data Analyst – tests advanced functionality and application of visual best practices. Tableau Server Certified Associate – tests administrative functionality and platform knowledge.
	Professional	Tableau Certified Consultant - tests ability to lead design of analytics solutions within the Tableau platform, ability to handle complex performance issues independently. Tableau Certified Architect - intended for roles that implement complex deployments of Tableau Server in enterprise-level environments. Tests knowledge in designing, deploying, monitoring, and maintaining a scalable Tableau platform, as well as migrations to Tableau Cloud

Online, proctored exams are delivered 24/7 . Instead of traveling to testing centers, users can test anywhere in the world if they meet computer and network requirements. Exams are also delivered in person at select Tableau events, like Tableau Conference.

NOTE: *How are Certification badges different from Skill badges?*
 Certification badges recognize users' significant achievement of proving product knowledge by passing high-stakes, proctored, secure exams. Skill badges recognize users' less significant achievement of passing self-proctored, non-secure skills assessments.

Skill Belts

A skill belt program is an internally-created badge and reward program that aligns with an internally curated education program. A skill belt program should motivate and reward users who sequentially build measurable knowledge in product functionality, storytelling, design, best practices in visualization and performance, and community resources. In order to complete each skill level, users should be required to volunteer as peer and mentor resources for new applicants. This ensures participation and organically builds community across the organization by encouraging users to share knowledge, evangelize data-driven decision making, and motivate others to improve their Tableau skills.

A skill belt program relies on both applicants and champions for administration, governance, and promotion. You may have additional resources to help administer the program. For example, many large organizations have learning management systems and may prefer to manage assessments within those content delivery systems.

Required content and measurement tools can be standardized across skill belts and merit badges; for example:

- Hands-on — Instructional videos or webinars for users to follow along with, often including accompanying Tableau workbooks.
- Whitepapers — Written, long-form instructional documents for users to read.
- Best practices — Consumable content in a variety of formats that generally focuses on visual and performance best practices. Content will include more technical and governance-related topics as users achieve higher skill levels.
- Storytelling — Consumable content in a variety of formats that specifically addresses the soft skills users need to effectively tell stories with data.
- Blogs — Informational content from a variety of sources, generally from Tableau or notable public community figures such as Tableau Visionaries. Content may include hands-on activities, best practices, or additional resources.
- Reference materials — Reference documents, community guides (e.g., GitHub), other instructional reference materials (e.g., chart hierarchy) and other supplemental materials.
- Challenges — Tableau workbook practices for users to complete, with solutions included for reference.
- Milestones — Significant tasks users must complete to achieve a skill belt or a merit badge.

You should not expect everyone to engage in all the available content, nor to master all the available skills at every skill belt level. Advancement through the program should be based on exposure to concepts and building knowledge, not mastery. For example, users can achieve

expert-level recognition without having to learn to script in Python. Only some users need to script in Python, but all users need to demonstrate an understanding of how Python and Tableau can be used together and, more importantly, how this can help the organization.

Gamification

A defining characteristic of any skill belt program is the gamification of learning. Gamification is an educational approach to motivate students to learn by using game elements and design in a learning environment. It can help users overcome fatigue or anxiety and keep them engaged. By incorporating the right mechanics, gamification can increase engagement and participation and inspire users to continue learning.

One successful way to gamify is by offering compensation or a reward (e.g., organizational status) for academic achievements, proper behavior and social engagement like helping peers, commenting, and adding value. Skill belts and merit badges can be designed to recognize academic achievement and volunteerism while communicating status or prestige within your organization. To encourage engagement, you should come up with fun skill belt and badge names. "Jedi Master" sounds a lot more exciting than "Analytics Expert." Perhaps you want to involve your community in picking the belt names (e.g., a contest). If your community picks the names, they are already invested in success before you have kicked off the program.

Another important feature of gamification is to make the program as social as possible to simulate the feel of a classroom or classroom community. This is important for achievers that need peer recognition, but also motivates through peer pressure or friendly competition with other participants. You can have a leader board to display top scores and vizzes, for example. We also suggest events such as Makeover Monday and Viz Games to increase competition and provide additional reward and recognition opportunities. Lastly, the program should be transparent to participants. While advancing within the course work users know what the next step is and what to expect. This creates anticipation! Anticipation is a strong motivator and gets students excited and engaged for longer periods of time and the flow of learning.

Volunteer Recognition

Employees who volunteer for your [Peer-to-Peer Assistance](#) programs deserve recognition. Employees who volunteer for your peer-to-peer assistance programs deserve recognition because they are actively helping others make better decision through data and strengthening your Data Culture overall. Here's a few example of how to recognize volunteers:

- When you host a Tableau User Group, spend some time highlighting those who are volunteering to make your organization more data-driven.
- If you're the Community leader, provide impactful metrics and feedback to the volunteer's manager (patient satisfaction scores, use cases supported, and specific contributions). Setting up surveys and asking for Data Doctor feedback is a good way to get inputs and quotes about a volunteers' contributions, which can be valuable inputs for periodic or end-of-year evaluations.

Measurement of Tableau User Engagement and Adoption

As Tableau is deployed broadly across your organization to users of all skill levels, administrators need to ensure that the content that is being created and consumed is discoverable, fresh, and relevant to your audiences. To accomplish this, administrators should measure the user engagement and adoption.

Measurement helps your deployment to operate at scale and evolve. It helps you understand user behaviors—who is creating and consuming content and the quality, the relevance of the dashboards and data sources being published, and the use of certified versus sandbox content. If content isn't being consumed, you will be able to identify it and take the appropriate next steps to archive or delete it.

BEST PRACTICE RECOMMENDATION:

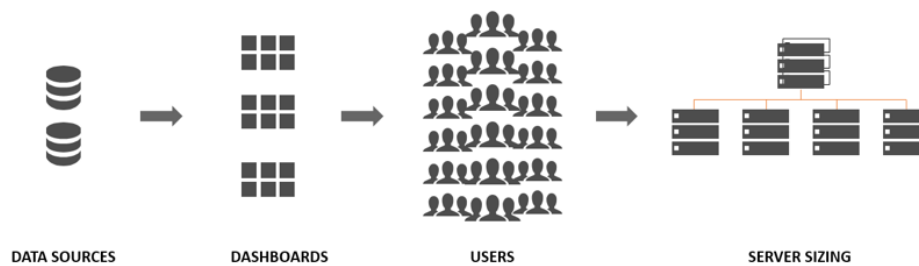
Combine the measurement of Tableau user engagement and adoption data with [Tableau Monitoring on page 183](#) data to shape new behaviors and accelerate towards your goal of becoming more data-driven by taking these insights into [Internal Tableau Activities on page 287](#) like admin, user, and champion group meetings.

For example, if you found a limited number of Published Data Sources and none of those have been certified, adding a session to your next user group meeting on identifying use cases, prioritizing publishing by audience size, and certifying data sources using your organization's best practices checklist will enable new data curation skills.

Understanding the relationship between data sources and workbook content, users, and system performance, scalability, and sizing is a reliable way to look into current usage and future growth. Open communication between Tableau Server Administrators and Tableau Site Administrators/Project Leaders or Tableau Cloud Site Administrators and Project Leaders is needed to plan for new users and use cases on the platform. Consider this:

- A team or group of users has a known collection of sources of data that can be identified and prepared for them as Published Data Sources or embedded in workbooks.
- Published Data Sources, as well as embedded data sources, are used to populate dashboards.
- Dashboards have a specific audience, or group of users who should view them.

- For Tableau Server specifically, user engagement drives server scalability and sizing decisions to define hardware requirements, which are aligned with budget planning and procurement requests. Because Tableau Cloud is a hosted analytics solution, scaling is managed by Tableau.



Measurement Roles and Responsibilities

During the initial planning stage, [Tableau Project Team Roles and Responsibilities on page 72](#) were defined and assigned. Depending on the size of the organization and deployment, measurement and monitoring responsibilities may be split across different teams.

At a minimum, you must have a Tableau Server Administrator or a Tableau Cloud Site Administrator. If your organization is just getting started with Tableau or the deployment size is small, a single person can fulfill the monitoring and measurement responsibilities, as well as the tasks to run the day-to-day operations of content organization, permissions, and user and group management. In larger deployments, these roles typically focus on technical platform and Tableau Server or Tableau Cloud application monitoring only. For more information, see [Monitoring Roles and Responsibilities on page 184](#).

When you begin to scale Tableau more broadly, it will be necessary to delegate the responsibility for measuring content utilization, user engagement, adoption to other users who will have a better understanding of business goals, key metrics, and expected traffic and behaviors for their respective areas. The Tableau Site Administrator and Project Leader roles have scoped administrative responsibilities. Site Administrators are scoped to the Tableau Server site level or Tableau Cloud site level, while Project Leaders are scoped to projects.

Tableau Role

Measuring Responsibilities

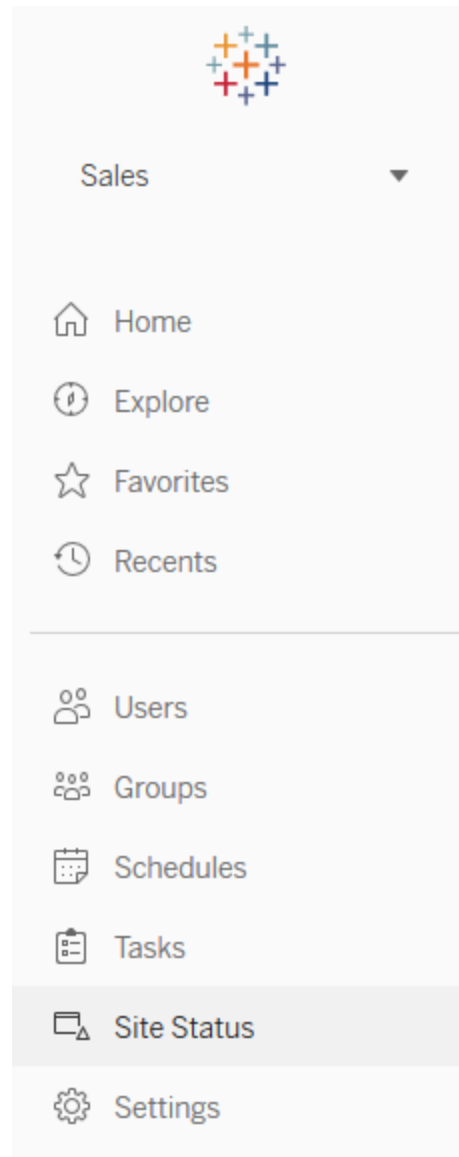
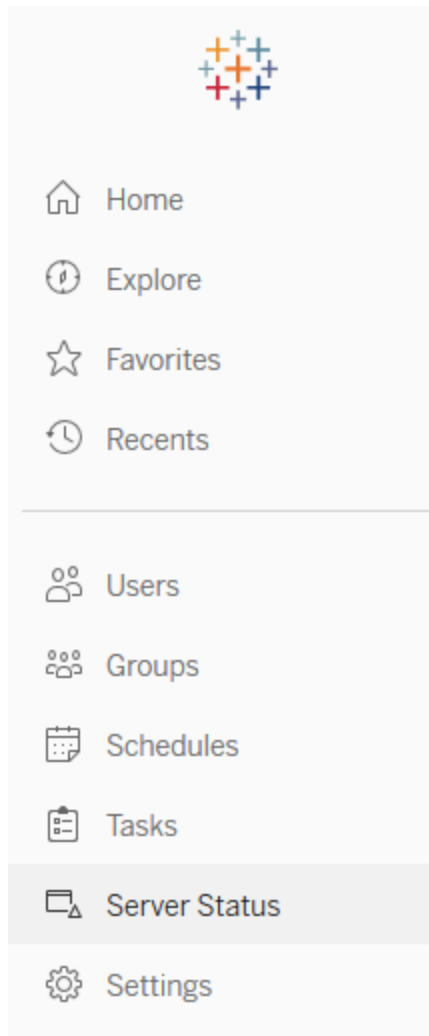
Tableau Site Administrator	<p>When sites are required to isolate a subset of users, groups, and content in Tableau Server, Tableau Server Site Administrators use default and custom site-level administrative views to measure content and data source traffic, content performance and size, job status, direct and indirect user engagement, and other behaviors such as login frequency and days since last login.</p> <p>In Tableau Cloud, Site Administrators are the highest administrator role. Tableau Cloud Site Administrators use default administrative site-level views and Tableau Cloud Admin Insights to measure content and data source traffic, content performance and size, job status, direct and indirect user engagement, and other behaviors such as login frequency and days since last login.</p>
Project Leader	<p>The Project Leader setting provides a way to allow multiple users access to a project, its child projects, and all workbooks and data sources in those projects. A project leader does not have to be a project owner or administrator. Project Leaders will use content created from Tableau Server Insights or Tableau Cloud Insights to measure content utilization and user engagement for their respective projects.</p>

Administrative Views for Measurement

Data from the Tableau Server repository or Tableau Cloud Admin Insights will be analyzed using default administrative views and custom administrative views. Administrative views are dashboards that are included with Tableau Server or Tableau Cloud and help you understand how users are interacting with content. Site Administrators have access to default **administrative views**. You navigate to Administrative Views on the Server or Site Status Page as shown below.

Server Status

Site Status



Brief descriptions of the site default administrative views are shown below. Site Administrators should view these on a weekly basis to understand the users' behavior.

- Traffic to Views — Usage and users for published views. Compare the traffic to the expected audience size. ([Tableau Server](#))
- Traffic to Data Sources — Usage and users for published data sources. Compare the traffic to the expected audience size. ([Tableau Server](#))

- Traffic to Bridge Connected Data Sources — (Tableau Cloud)
- Actions by All Users — Actions for all users to see site activities. (Tableau Server)
- Actions by Specific User — Actions for a specific user, including items used. (Tableau Server)
- Actions by Recent Users — Recent actions by users, including last action time and idle time. (Tableau Server)
- Background Tasks for Extracts — Completed, pending, and failed extract task details with full details of why an error occurred. (Tableau Server | Tableau Cloud)
- Bridge Extracts — (Tableau Cloud)
- Background Tasks for Non Extracts — Completed, pending, and failed non-extract background task details with full details on why an error occurred. (Tableau Server | Tableau Cloud)
- Stats for Load Times — View load times and performance history. (Tableau Server)
- Stats for Space Usage — Space used by published workbooks and data sources, including extracts and live connections. (Tableau Server | Tableau Cloud)
- Stale Content — (Tableau Server | Tableau Cloud)

Custom administrative views are useful for deeper analysis of user behaviors and organization-specific KPIs that are identified. The Tableau Server Administrator will extract and publish the default administrative views workbook and its data sources so others can better understand data, content, and user behavior.

Users and project leaders who manage content (but are not full administrators) should be able to view and measure consumption. For Tableau Server and Site Administrators, with the default administrative views workbook published, **data-driven alerts** can be set, such as long view load times or to identify which workbooks and data sources exceed the expected size limit. This means that if you set a standard that extract sizes should be less than 1 GB, then alert for anything 1GB or larger on the Stats for Space Usage View. In addition, community-supported data sources, known as **Tableau Server Insights**, are available for download from GitHub.

Tableau Server Insights data sources are shown below:

- TS Background Tasks — Primarily for analyzing Extract Refresh and Subscription tasks that are run on Backgrounder processes.
- TS Content — High-level, summarized data for each view, workbook, and Published Data Source on Tableau Server.
- TS Data Connections — Maps both workbooks and published data sources to their underlying data connections. Useful for answering questions about what workbooks connect to what data source, which then connects to what database(s)?

- TS Events — Master audit data source showing events happening on Tableau Server— users signing in, accessing views, publishing content, etc.
- TS Users — Aggregated information on user activity.
- TS Web Requests —Requests made through the Tableau Server web server component. Useful for understanding user interaction with vizzes, as well as performance monitoring.

Tableau Cloud Site Administrators will create the Admin Insights project and data sources. Initially, this project and content is visible to site admins only. Tableau Cloud Site Administrators should consider who will benefit from this data and grant permissions to it accordingly. Tableau Cloud Admin Insights data sources are shown below:

- TS Events — Master audit data source showing events—users signing in, accessing views, publishing content, etc.
- TS Users — Aggregated information on user activity.

Tableau Content Utilization

Utilization is the effective use of the data visualizations for business decisions but the complete picture cannot be told through Traffic to Views alone. When viewing this data, put it in the context of your expected audience size that was documented on the Use Cases tab of the [Tableau Blueprint Planner](#). Tableau Server deployments will use the Tableau Server Repository to [create custom views](#) with [Tableau Server Insights](#). Tableau Cloud Site Admins have access to curated data sources called [Admin Insights](#).

For example, if a Published Data Source has an audience of 500 users who should use it at least once a day, then we would expect the Traffic to Views dashboard to show approximately 10,000 views in a month (20 business days * 500 users). Now, if 250 people view the dashboard 2 times a day, then you're at 50% engagement and that's your cue to understand whether the information is relevant, there is a skills gap, or half the audience doesn't realize that such a dashboard that will help them do their job even exists.

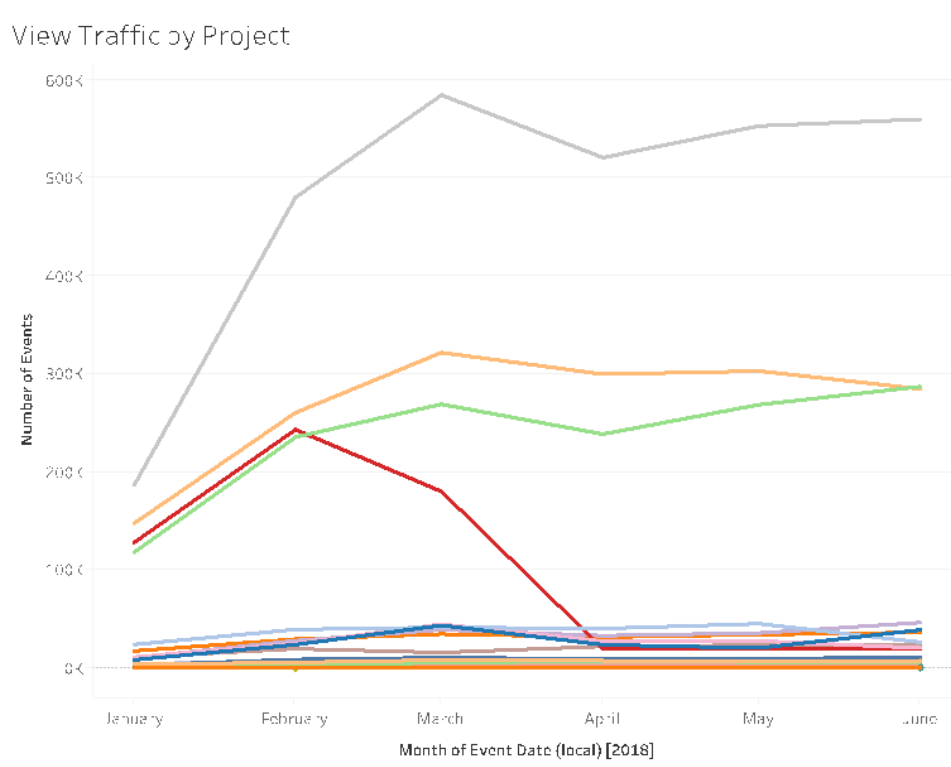
For content published to Tableau Server, individual content creators can see utilization for their content in the sparkline tooltip by hovering over the workbook's thumbnail or selecting Who Has Seen This View from the menu. In Tableau Cloud, you can understand who has accessed a viz by using the TS Events Admin Insights data source. For more information about Tableau Cloud Admin Insights, see [Explore the Data Sources](#).

Tableau Blueprint Help



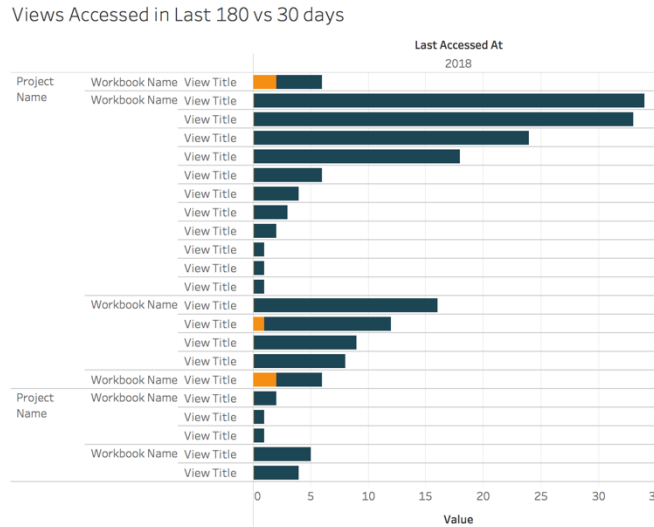
Content Utilization

1. Within a site or project, what is the view traffic? (Monthly) — Understanding the usage trend for a site and project will help you understand growth or whether additional community activities can educate users on available content. Below, you can see traffic in the project represented in red has dropped off dramatically, while the remaining colors at the bottom are flat. Use TS Events in both Tableau Server Insights and Tableau Cloud Admin Insights.

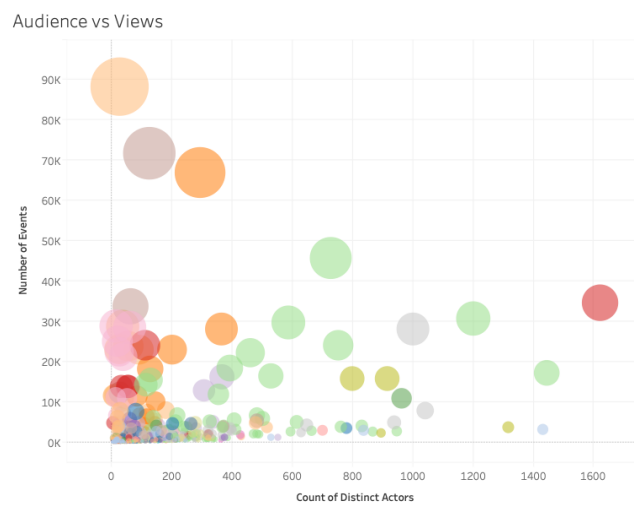


2. What is view traffic in last 180 days vs 30 Days? (Monthly) — Low traffic views should be reviewed and archived based on activity threshold within a time period. If content is published

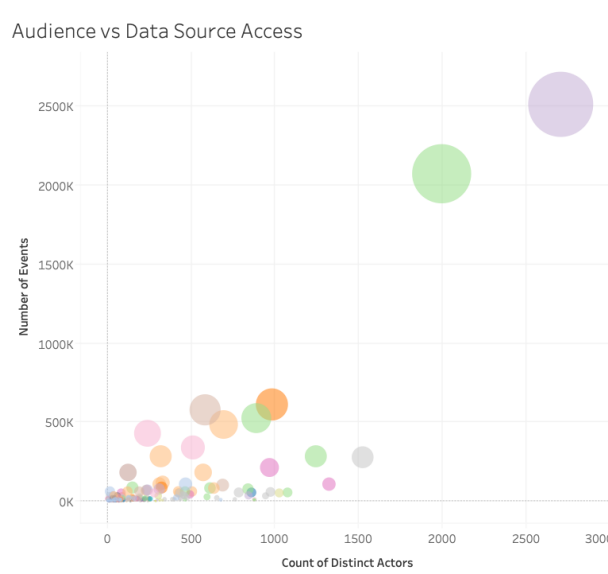
but not viewed, it is consuming system resources and potentially making it harder for users to locate more relevant content. In the example below, only three dashboards (orange) have had been accessed in the last 30 days. Use TS Content in Tableau Server Insights. Note: Tableau Cloud Admin Insights includes 90 days of data. For Tableau Cloud, you should measure Views Accessed in Last 90 vs 30 days using TS Events.



3. What is a workbook’s audience size relative to access events? (Monthly) — When identifying use cases for new content, you should estimate the audience size for a particular workbook. By comparing the distinct count of consumers to the number of access events, you can understand the impact of content. Content in the lower left (low audience/low traffic) should be reviewed and removed if it is no longer useful. Use TS Events in both Tableau Server Insights and Tableau Cloud Admin Insights.



- 4. What is a data source’s audience size relative to access events? (Monthly) — Similar to the previous example, when identifying use cases for new content, you should estimate the audience size for a particular data source. By comparing the distinct count of consumers to the number of access events, you can understand the impact of content. Content in the lower left (low audience/low traffic) should be reviewed and removed if it is no longer useful. Use TS Events in both Tableau Server Insights and Tableau Cloud Admin Insights.



- 5. Who is creating/owning content? (Monthly) — Users who create and share content are putting your organization’s modern analytics vision into practice. To understand who is pub-

lishing to Tableau, review project, workbook, and certified and uncertified data source owners. Use TS Users in both Tableau Server Insights and Tableau Cloud Admin Insights.

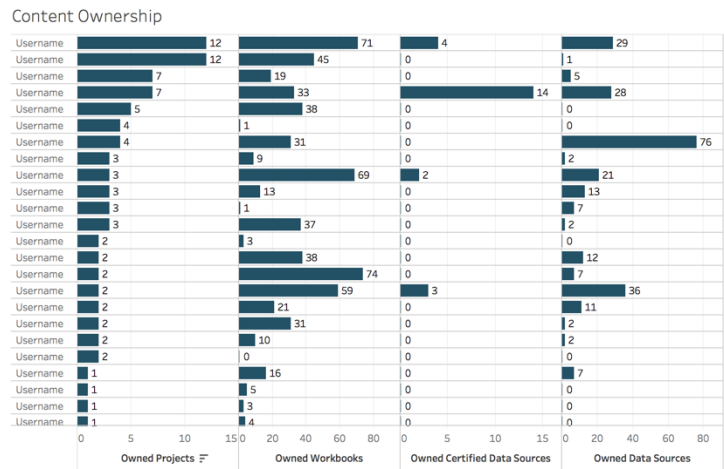


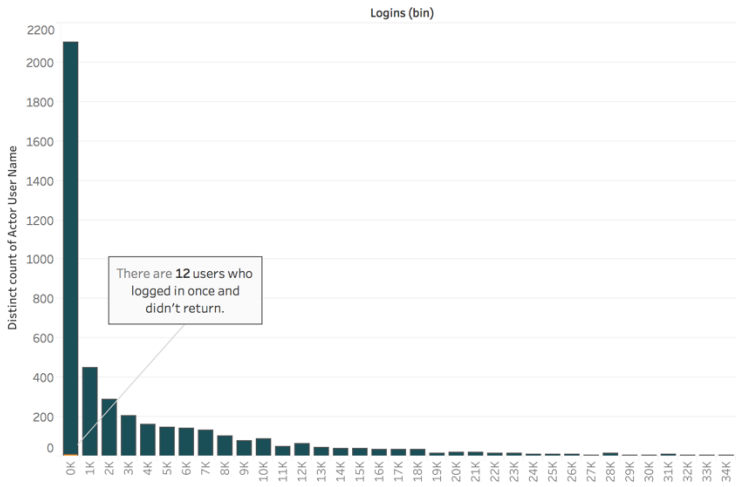
Tableau User Engagement

Engagement is a measure of user behavior, both direct and indirect. Direct engagement includes viewing and interacting with a dashboard, connecting to a data source, and web authoring. Indirect engagement includes subscriptions and alerts that are delivered to a user. Tableau Server deployments will use the Tableau Server Repository to **create custom views** with **Tableau Server Insights**. Tableau Cloud Site Admins have access to curated data sources called **Admin Insights**.

Login Frequency

How many times have users logged in? (Monthly) — To measure user engagement, you should start by quantifying the number of logins, users who login once and didn't return, and users who never logged in. If twelve users have logged in once and didn't return, you should determine why. Use TS Events in both Tableau Server Insights and Tableau Cloud Admin Insights.

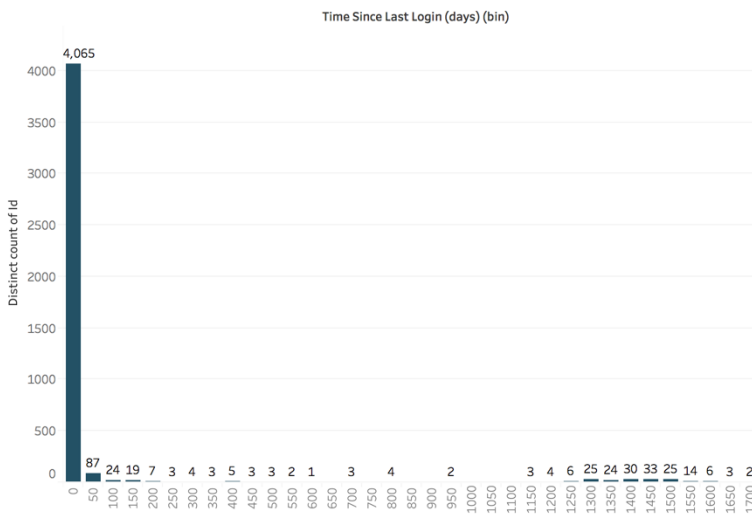
Login Frequency



Days Since Last Login

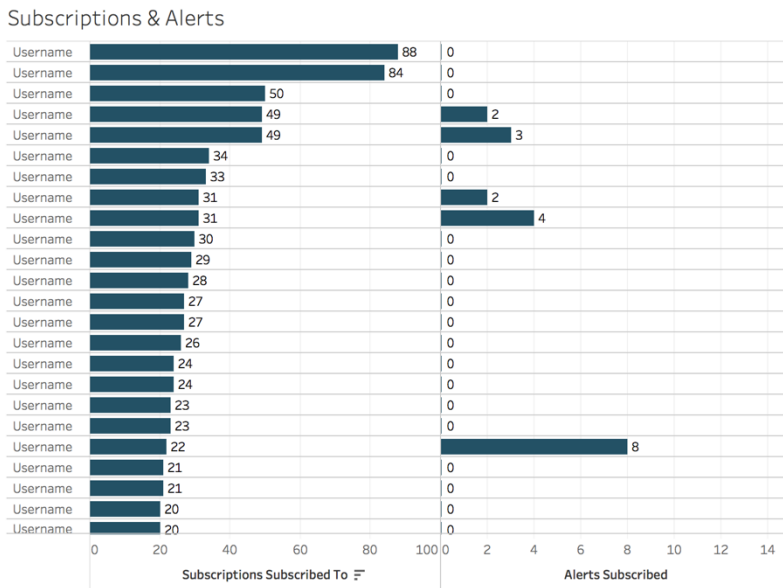
Is the use of content becoming habitual? (Monthly) — Quantifying the number of days since last login is a good indicator of whether users are in Tableau. For example, with 4,065 users logging in to Tableau from 0-49 days, use of Tableau is high. This can be especially useful if HR data is joined to view engagement within a department or team. Use TS Users in both Tableau Server Insights and Tableau Cloud Admin Insights.

Days Since Last Login



Subscriptions & Alerts

Are subscriptions and alerts being sent to users? (Monthly) — It's important to consider the direct (publish, view, and interact) and indirect (subscriptions and alerts) activity on Tableau. Even if users are not interacting directly with content, they may be receiving emails from subscriptions and alerts, and this can be quantified by filtering on the Send Subscription... and Send Data Driven Alert... events. Use TS Events in both Tableau Server Insights and Tableau Cloud Admin Insights.



Community Engagement

Are users finding the support they need? Quantifying user engagement data from your internal Tableau community can help surface recurring questions and overall adoption issues. In this example, we'll dive into measuring the impact of a Data Doctor program within an internal community.

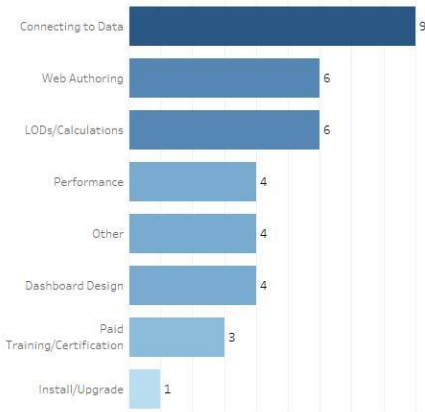
Popular metrics include the number of Data Doctor appointments over a period of time and the percentage of returning peers who ask questions, together giving a baseline to the quantity and focus of your users' issues. Other metrics can include growth of the Data Doctor or Tableau Champions team, or the number of Tableau Days attendees.



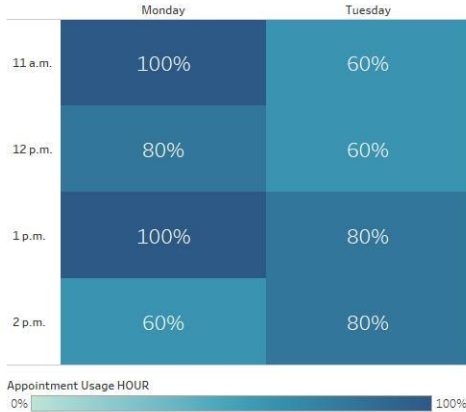
Tableau Community Engagement Metrics Last Updated: May 7, 2021



Top Questions Categories



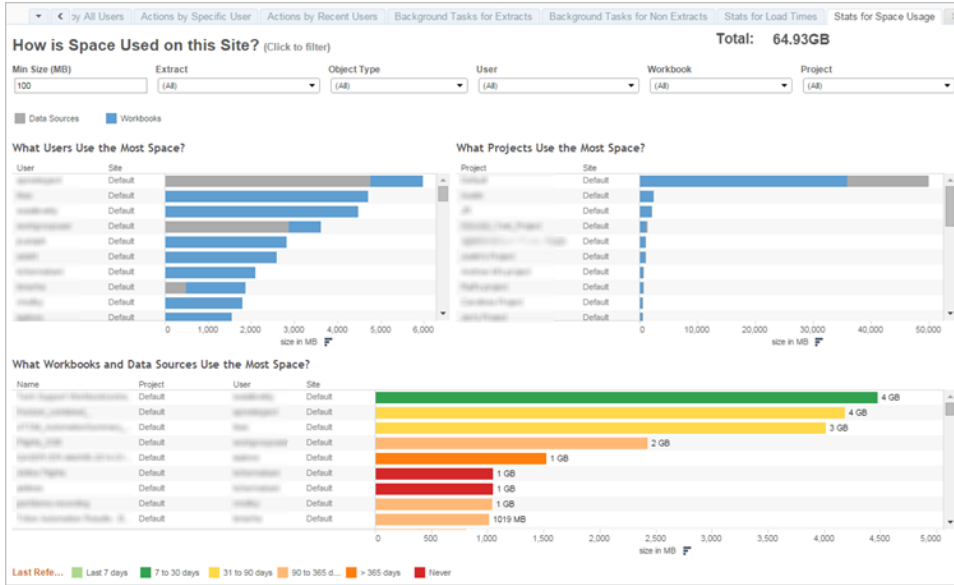
Data Doctor Appointment Usage by Hour



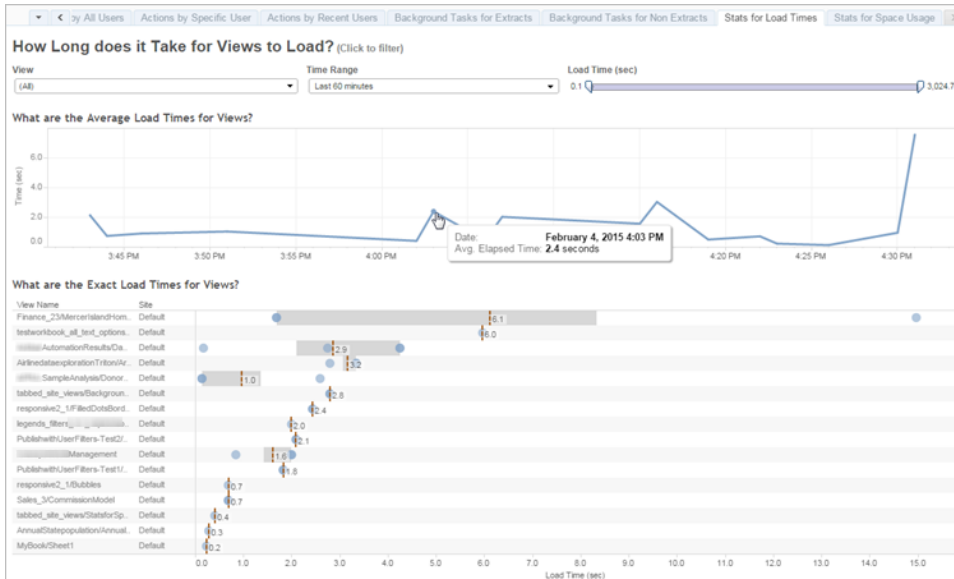
Content Size and Performance

Performance is a shared responsibility in Tableau Server and Tableau Cloud because of the cumulative effects of slow dashboards and long-running extract refreshes can have on the entire system. Based on performance thresholds you define, you should work with users to improve performance to expectations. The dashboards below can be found in the [default administrative views](#) on Tableau Server and Tableau Cloud. To access administrative views in Tableau Server or Tableau Cloud your [site role](#) must be set to either Server Administrator or Site Administrator Creator.

1. What is the distribution of workbook and data source size? (Weekly)

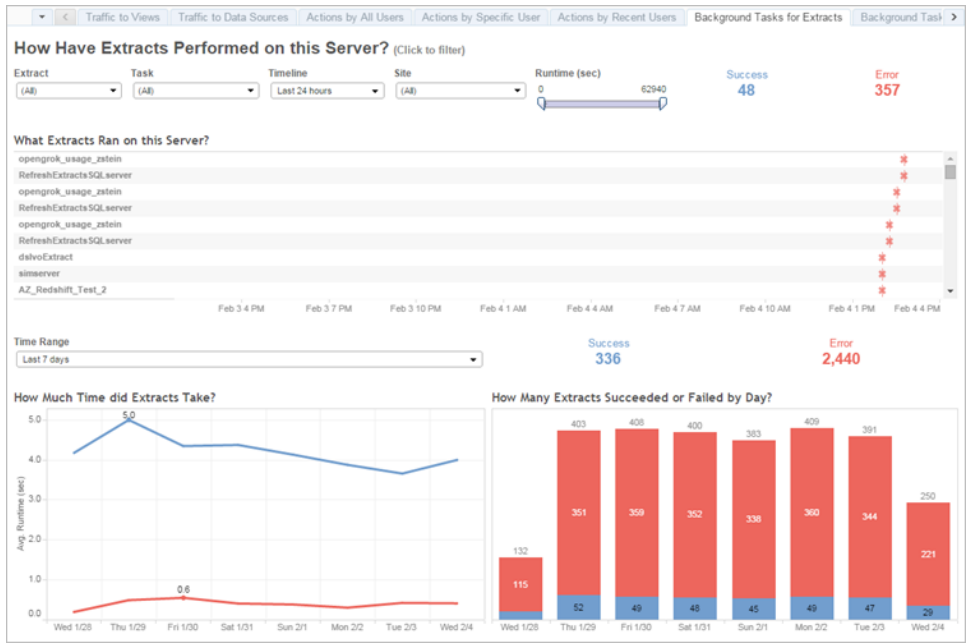


- Tableau Server only: How long does it take for views to load? (Weekly) — Have you set a load time expectation to identify when a workbook is loading too slowly? Do you have an exception procedure in place?

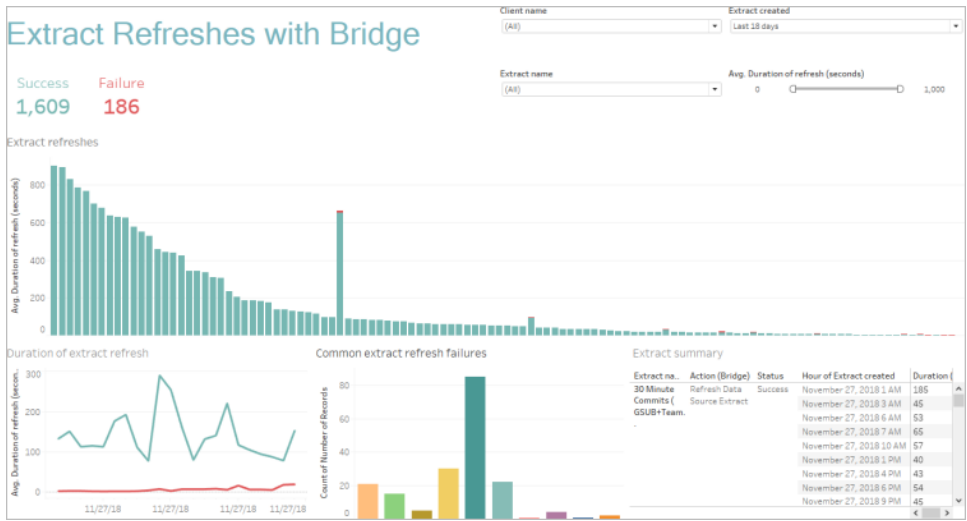


- How are extracts performing? (Weekly) — See the successes and failures of extracts and determine if you're experiencing long extract refresh times.

Tableau Blueprint Help



4. Tableau Cloud only: How are Bridge clients performing? (Weekly)



5. Are subscriptions delivered on time? (Weekly)

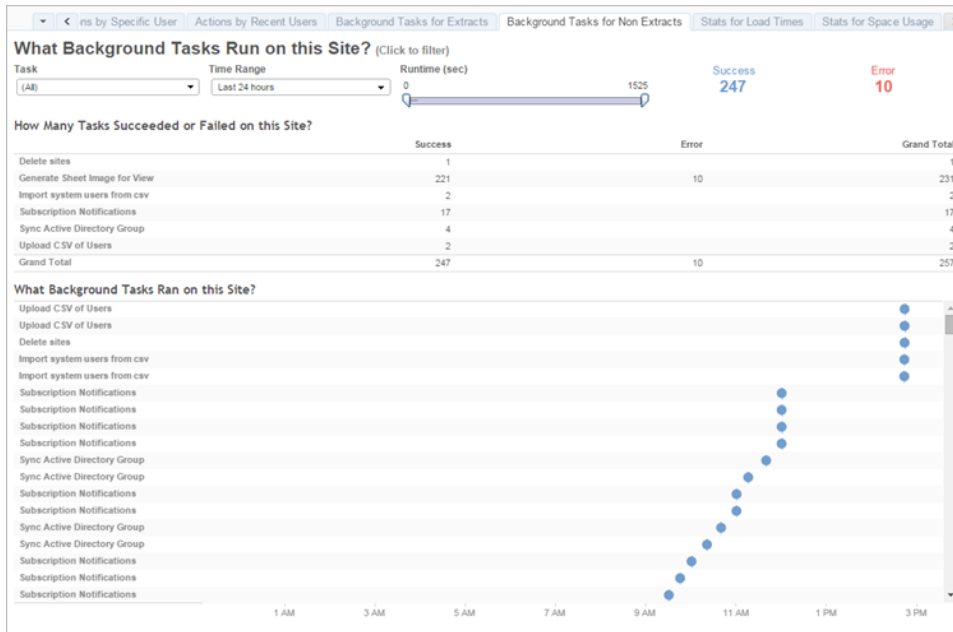


Tableau Accelerators

Tableau Accelerators are pre-built dashboards designed to help you get a jumpstart on your data analysis. Our collection of Accelerators includes two dashboards that administrators can use to improve dashboard load times at scale; read [more on the Tableau blog](#).

Access the complete set of Accelerators on the [Tableau Exchange](#) and in Tableau Desktop. Additionally, select Accelerators are available to use when you create a workbook in Tableau Cloud.

Compliance

Compliance is the measure of how users are following internal company policies and procedures and external regulations where applicable. Below are some examples of policies to be defined or may already be in place:

1. Are usernames and passwords using a service account or an individual account? (Weekly)
2. Are embedded passwords elevating permissions for data access? (Weekly)

Tableau Blueprint Help

3. When implementing Row Level Security at Tableau Data Source or Dashboard level are appropriate measures taken on user permissions? Such as who can and cannot do editing/download? Can the RLS be pushed to database level?
4. Are visual styles being adhered to? (Colors, branding, type of visualization, etc.)

Analytics Best Practices in Tableau

Analytics best practices enable your users with guidelines, standards, and processes for the discovery, interpretation, and presentation of data. In addition to the common best practices listed here, consider what additional organization-specific practices you will layer on top to enable your users with repeatable processes that will evolve into analytical capabilities.

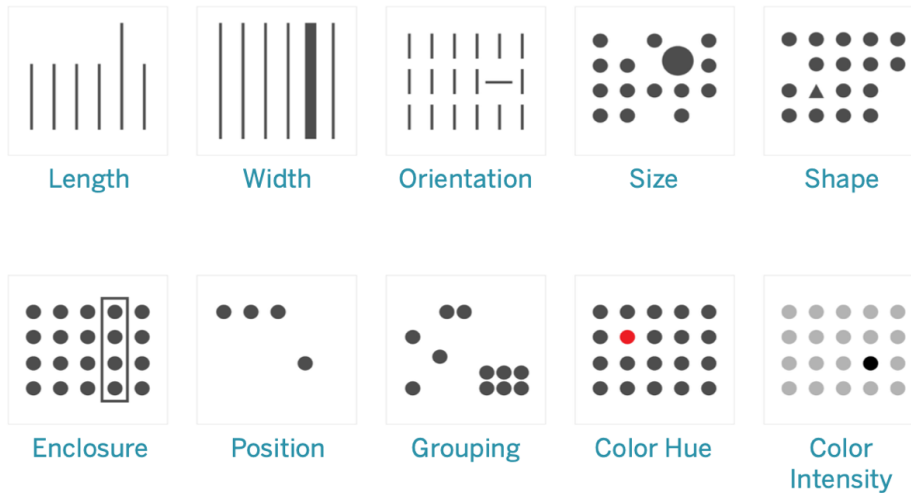
Once defined, you should publish your organizational best practices to the [Tableau Enablement Intranet on page 277](#). A mix of pre-recorded content, web meetings, and in-person sessions should also be used to introduce, reinforce, and institutionalize best practices as part of transforming into a data-driven organization. While not intended to be an exhaustive list, this document compiles some of the most common analytics best practices.

Why Visual Analytics?

Visual analytics is a means of exploring and understanding data. It supports and accelerates the analysis process itself. You can ask a question, get the answer, and ask follow-up questions—all within a visual interface. A story unfolds from one visual summary to another. Later, you can retrace the story to rethink, explore further, and share. In short, visual analytics allows you to go in any direction with your thoughts while you view and interact directly with the data.

Pre-attentive Attributes

Visual analytics leverages pre-attentive attributes to guide you down the most useful paths. Pre-attentive attributes are information we can process visually almost immediately, before sending the information to the attention processing parts of our brain. The pre-attentive attributes are shown below.



Pre-attentive Attributes

These are generally the best ways to present data, because we can see these patterns without thinking or processing. In fact, these attributes evolved in humans as ways to quickly assess a situation, discern a pattern, and choose whether to react. When authoring visualizations in Tableau, content creators will be visually encoding data to reveal new insights.

Explaining Visual Encoding

As you deploy Tableau broadly across the organization, some people will see the immediate value of visual analytics while others may hold on to traditional spreadsheets or reports in a tabular format. You will likely need to communicate the value of visual analytics and help those people see data differently by walking through what's possible when data is visually encoded—namely by using color, shape, and size.

The steps below are helpful in making data visualizations more familiar if you are creating them for someone else. First, start with a familiar tabular format. Here is an example of how someone might view sales and profit in a text table. To find the highest and lowest values, it requires a full table scan of the rows and columns.

Tableau Blueprint Help

Sales & Profit Table

Category	Sub-Category	Region							
		Central		East		South		West	
		Sales	Profit	Sales	Profit	Sales	Profit	Sales	Profit
Furniture	Chairs	\$85,231	\$6,593	\$95,267	\$9,356	\$45,176	\$6,612	\$101,781	\$4,028
	Tables	\$39,155	-\$3,550	\$39,140	-\$1,025	\$43,916	-\$4,623	\$84,755	\$1,483
	Bookcases	\$24,157	-\$1,998	\$43,819	-\$1,168	\$10,899	\$1,339	\$36,004	-\$1,647
	Furnishings	\$15,254	-\$3,906	\$29,071	\$5,831	\$7,307	\$3,443	\$30,073	\$7,641
Office Supplies	Storage	\$45,930	\$1,970	\$71,613	\$9,389	\$35,768	\$2,277	\$70,533	\$8,645
	Binders	\$56,923	\$1,044	\$3,498	\$1,258	\$7,030	\$3,901	\$5,961	\$16,997
	Apparances	\$23,582	\$2,639	\$34,085	\$8,391	\$9,525	\$4,124	\$30,236	\$8,261
	Paper	\$17,482	\$6,972	\$20,173	\$8,015	\$4,151	\$5,847	\$26,664	\$2,119
	Supplies	\$9,467	-\$662	\$10,760	-\$1,155	\$8,319	\$2	\$18,127	\$528
	Art	\$5,765	\$1,135	\$7,486	\$1,900	\$4,656	\$1,059	\$9,212	\$2,374
	Envelopes	\$7,637	\$1,778	\$4,376	\$1,812	\$3,346	\$1,765	\$7,118	\$1,909
	Labels	\$2,451	\$1,073	\$2,803	\$1,128	\$2,353	\$1,041	\$5,079	\$2,303
	Fasteners	\$778	\$237	\$820	\$264	\$563	\$74	\$923	\$275
Technology	Phones	\$72,408	\$2,323	\$106,615	\$12,315	\$58,364	\$10,767	\$98,684	\$9,111
	Machines	\$26,797	-\$1,486	\$65,106	\$6,929	\$3,891	-\$1,439	\$42,444	-\$619
	Accessories	\$33,956	\$7,252	\$45,033	\$11,196	\$27,277	\$7,005	\$61,114	\$16,485
	Copiers	\$37,260	\$15,609	\$33,218	\$17,023	\$9,300	\$3,659	\$19,719	\$19,327

Tabular Data, Plain

Adding color to negative numbers and formatting them with parentheses makes them stand out, but only if you're looking for negative numbers. For everything else, a table scan is required to compare values.

Sales & Profit Table

Category	Sub-Category	Region							
		Central		East		South		West	
		Sales	Profit	Sales	Profit	Sales	Profit	Sales	Profit
Furniture	Chairs	85,230.65	6,592.72	95,260.68	9,357.77	45,176.45	6,612.09	101,781.33	4,027.58
	Tables	39,154.97	(3,559.65)	39,139.61	(1,025.33)	43,916.19	(4,623.06)	84,754.56	1,482.61
	Bookcases	24,157.18	(1,997.90)	43,819.33	(1,167.63)	10,899.36	1,339.49	36,004.12	(1,646.51)
	Furnishings	15,254.37	(3,906.22)	29,071.39	5,831.41	7,306.68	3,442.68	30,072.73	7,641.27
Office Supplies	Storage	45,930.11	1,969.34	71,612.53	9,389.37	35,768.06	2,277.30	70,532.85	8,645.32
	Binders	56,923.28	(1,043.64)	3,498.00	11,267.93	7,030.34	3,900.66	5,961.11	16,998.60
	Apparances	23,582.03	(2,638.62)	34,086.47	8,391.41	9,525.33	4,123.94	30,236.34	8,261.27
	Paper	17,481.90	6,971.90	20,172.60	8,015.37	4,150.88	5,847.06	26,663.72	2,119.24
	Supplies	9,467.37	(661.89)	10,760.12	(1,155.14)	8,319.93	1.88	18,127.12	626.05
	Art	5,765.34	1,135.16	7,485.76	1,899.94	4,655.62	1,058.59	9,212.07	2,374.10
	Envelopes	7,636.87	1,777.53	4,375.67	1,812.41	3,345.56	1,765.48	7,118.10	1,908.76
	Labels	2,451.47	1,073.08	2,802.83	1,129.25	2,353.18	1,040.77	5,078.73	2,303.12
	Fasteners	778.03	236.62	819.72	263.99	563.32	73.72	923.22	275.19
Technology	Phones	72,403.28	2,323.03	106,614.98	12,314.69	58,364.44	10,767.28	98,684.35	9,110.74
	Machines	26,797.38	(1,486.07)	65,106.17	6,928.64	3,890.96	(1,438.39)	42,444.12	(618.93)
	Accessories	33,956.08	7,251.63	45,033.37	11,195.86	27,278.75	7,004.54	61,114.12	16,484.60
	Copiers	37,259.57	15,609.54	33,218.46	17,022.84	9,299.76	3,659.91	19,719.24	19,327.24

Tabular Data with a Color for Negative Values

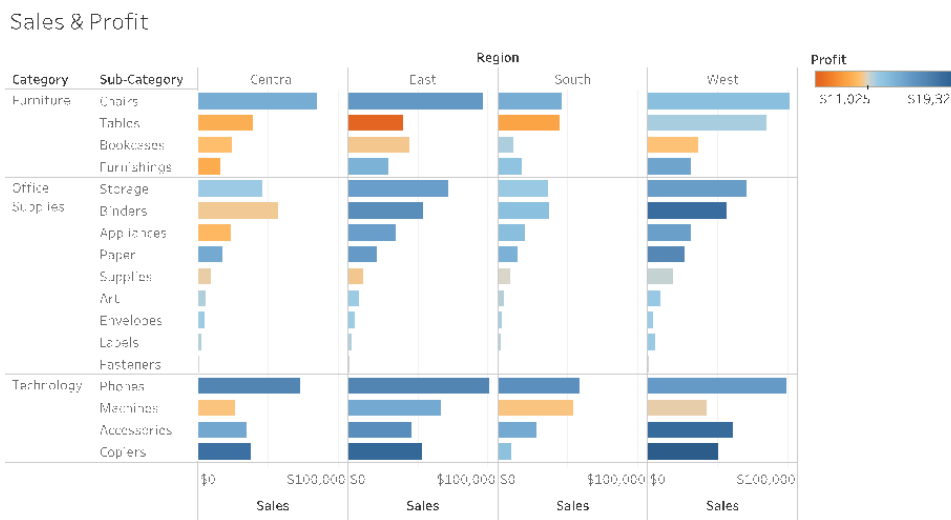
Next, as an intermediate format between a text table and a full visualization, color can be applied to the sales and profit measures individually to show high and low values, but it still requires the viewer to reconcile ranges of color between the two measures.

Sales & Profit Highlight Table

Category	Sub-Category	Region							
		Central		East		South		West	
		Sales	Profit	Sales	Profit	Sales	Profit	Sales	Profit
Furniture	Bookcases	\$24,157	\$7,998	\$43,819	\$1,168	\$10,839	\$1,339	\$36,104	\$7,647
	Chairs	\$85,231	\$6,583	\$96,261	\$9,358	\$45,176	\$6,612	\$131,781	\$4,028
	Furnishings	\$15,254	-\$3,906	\$29,871	\$5,881	\$17,307	\$3,443	\$30,073	\$7,641
	Tables	\$39,155	-\$3,560	\$39,140	-\$11,025	\$43,916	-\$4,623	\$84,755	\$1,483
Office Supplies	Appiances	\$23,582	-\$2,639	\$34,183	\$9,391	\$19,525	\$4,121	\$30,236	\$8,261
	Art	\$5,765	\$1,195	\$7,488	\$1,900	\$4,656	\$1,059	\$9,212	\$2,374
	Binders	\$5,923	\$7,044	\$13,498	\$17,288	\$37,930	\$3,961	\$5,981	\$16,097
	Envelopes	\$4,637	\$7,778	\$4,376	\$1,812	\$3,346	\$1,465	\$4,718	\$7,909
	Fasteners	\$778	\$237	\$820	\$264	\$503	\$174	\$923	\$275
	Labels	\$2,451	\$1,073	\$2,603	\$1,120	\$2,353	\$1,041	\$5,079	\$2,303
	Paper	\$17,492	\$6,972	\$20,173	\$9,019	\$14,151	\$5,947	\$26,664	\$12,119
	Storage	\$15,330	\$1,970	\$71,613	\$8,308	\$35,768	\$2,274	\$70,533	\$9,675
	Supplies	\$9,487	\$652	\$10,760	\$1,155	\$8,319	\$27	\$15,177	\$628
Technology	Accessories	\$33,956	\$7,252	\$45,833	\$17,196	\$77,277	\$7,065	\$67,114	\$16,485
	Copiers	\$37,260	\$15,609	\$53,219	\$17,023	\$9,380	\$3,659	\$49,749	\$19,327
	Machines	\$26,797	-\$1,486	\$66,106	\$8,929	\$53,891	-\$1,439	\$42,444	-\$659
	Phones	\$72,403	\$12,323	\$100,015	\$12,315	\$58,304	\$10,767	\$98,684	\$9,111

Tabular Data with Sales and Profitability by Color Gradients

Finally, show the full visualization with sales encoded by length and profit encoded by color. Immediately, the viewer can see highest sales and lowest profit.

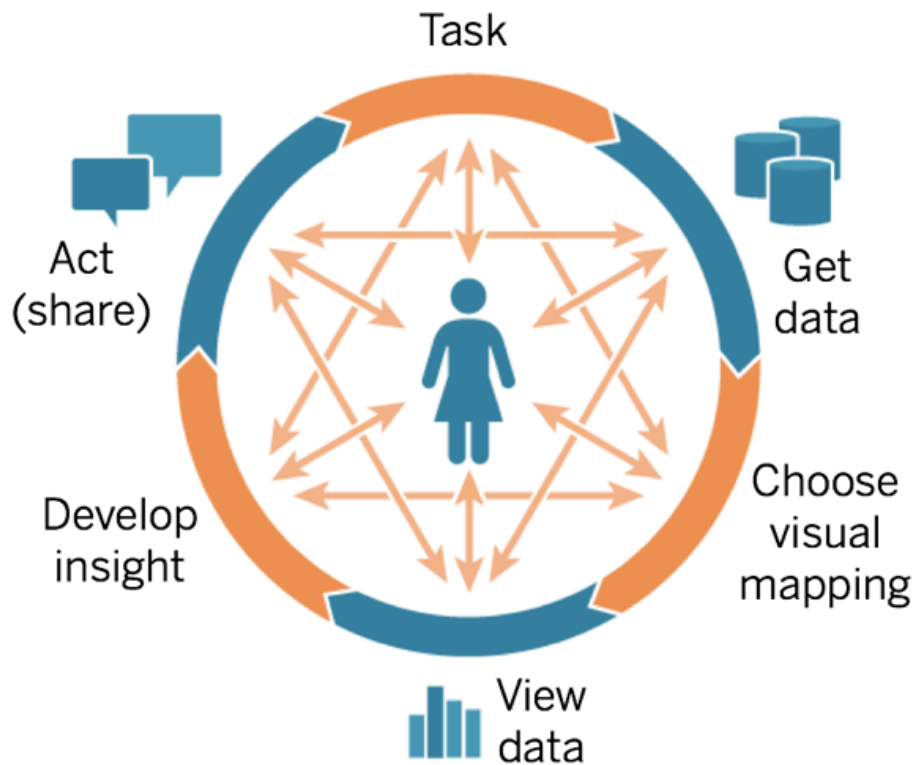


Visual Data with Sales by Bar Length, Profitability by Color

Using this approach, you will be able to introduce and explain the benefits of visual analysis to your organization’s Tableau users. You should record your own introduction video and post it on the enablement intranet.

The Cycle of Visual Analysis

Visual analysis is a non-linear process. For example, a user might start with an initial task or question in mind, find relevant data, and prepare it for analysis. During analysis, she realizes that she needs additional data, so she goes back a couple of steps to get more data, choose a new visual mapping, and develop a new insight. This example can be repeated for any of the other steps of the cycle of visual analysis.



The flow of analysis is difficult or impossible to achieve in traditional BI. Instead of exploiting the power of visual cues and iteration, it is heavily milestone-driven. Requirements gathering leads to development, then to testing, and eventually to launch. With visual analysis, the steps become more fluid as the answer to one question often leads to other questions, and new insights are uncovered.

Start with Questions

Whether you are authoring for yourself or for others, the cycle of visual analysis starts with a task or business questions to be answered. When asking data questions, start with a broad topic then add specificity to each question. For example, a call center manager's questions from summary to detail might look like the following:

- How many calls are received monthly?
- Where do the calls come from?
- What are the top call types?
- Who answers the most/least calls?

Often the person analyzing the data also understands the underlying business questions. In other cases, someone might come to you with a need for a dashboard and what business questions it needs to address. Regardless of what the process of requesting this kind of assistance is, the steps for success are similar.

- Build rapport for a productive working relationship built on trust. Find out about their experiences and try to speak their language.
- Ask open-ended questions like "What do you want this dashboard to tell you?" or "What question do you want to answer?" rather than "Do you want a line graph?" or "Should I make a trend line?"
- Use examples: Show existing dashboards and ask what would make them better.

Get Data

Your users have questions that can be answered with data, but do they know how to find the right source of data and connect to it? From a variety of structured, semi-structured, and raw sources of data to siloed data within different departments of the organization, knowing where to get the right data is one of greatest barriers to becoming a data-driven organization.

During the discovery process, the [Tableau Data and Analytics Survey on page 42](#) in the [Tableau Blueprint Planner](#) identified key sources of data and how data is distributed and consumed within each department or team. With specific sources of data documented on the [Tableau Use Cases and Data Sources on page 45](#) tab of the [Tableau Blueprint Planner](#), you should prioritize which ones will be most impactful by audience size and create Published Data Sources in Tableau Server or Tableau Cloud.

Beyond the initial use cases, content creators should understand how to get data to answer new business questions. Using the Data & Analytics Survey is a repeatable way to discover new use cases and assess whether the needed data exists already in Tableau Server and Tableau

Cloud. If it is already available as a Published Data Source, then content creators can connect to it and begin analyzing it. If it does not exist, authors should collaborate with Data Stewards and work with the data they have—even sample data files—and prototype with the data available, rather than waiting to proceed with a perfect operationalized dataset. Once the full data set is available, the operationalized dataset will replace the sample.

Choose Visual Mapping

After getting data, content creators will start to explore data by adding measures and dimensions to the view, and Tableau presents users with the most effective visualization. At any time in the authoring of content, the type of visualization can be changed. As creators explore the data and visually encode it with the pre-attentive attributes, they will be able to derive insights from it.

Choosing the appropriate type of visual mapping for the type of analysis is critical for deriving insights and driving towards action. There are five primary types of visual mappings that content creators and consumers should understand:

- Comparison, represented as a bar
- Spatial, represented as a map
- Temporal, represented as a line
- Compare two measures, represented as a scatterplot
- Precise number, represented as a text table

View Data

Tableau visualizations often show the unexpected—relationships, outliers, and trends. A surprise finding stimulates the thought process, encouraging deeper analysis or a different path of exploration. Tableau's interaction model is based on the concept of incremental change: Whenever you perform an action (e.g., filter), Tableau instantly shows you the new result.

Why is incremental change important? It lets us intuitively explore a broad space of possible visualizations to find the right one. It allows us to focus on the exploration task, where questions lead not just to answers but also to more questions. It also lets us learn visual analytics at our own pace. We can build sophisticated representations of data slowly and incrementally as we learn how to look at information. Tableau's interface is based on the process of incrementally refining a question into an answer. Every Tableau user, not just analysts, to be able to derive meaningful information from data and base their decisions on data.

Develop Insights

Data analysis and data visualization were once separate tasks. An analyst would run queries or write calculations to get answers from a data source, and then export results as a specified chart or graph. But by making the process querying data visual, you explore your data in a richer, more meaningful way. With visual analytics you can build an analysis and learn from it simultaneously as opportunities for further investigation present themselves.

Critical thinking with data is about finding insight, and communicating the insights in an optimal, engaging way. Visual analytics makes asking and answering questions of your data intuitive, regardless of whether you are a creator or a consumer—as we continue to ask “why”.

Critical thinking with data is important to the decision-making process for both content creators (often analysts, developers or data scientists) as well as for information consumers. Both groups should ask themselves these questions as they develop insights:

- What question should I ask?
- And when I get the answer, do I trust it?
- Do I have the ability to question if my data is useful? If it's correct?
- Am I using all the facts? Am I trying to confirm biases I have?

Act (Share)

Shared findings lead to actions, results, and solutions. In fact, unshared discoveries are useless. You can share different types of content via Tableau Server or Tableau Cloud:

- **Tableau Prep Flows:** Prep flows can be published to Tableau Server or Tableau Cloud and scheduled to run when you need them to with Prep Conductor.
- **Published Data Sources:** You can publish data sources that others can use to build new workbooks. A data source can contain a direct (or live) connection to your database or an extract you can refresh on a schedule. For more information, see [Best Practices for Published Data Sources](#) and [Enabling Governed Data Access with Tableau Data Server](#).
- **Workbooks:** Workbooks contain your views, dashboards, and stories, and data connection. You can include local resources, such as background images and custom geocoding, if they reside in a location that the server or other Tableau users cannot access.

A dashboard checklist is a useful resource to ensure that published content meets the purpose and answers the business questions intended. Data stewards should also play a role to ensure correctness and review an embedded data source as a potential candidate for publishing and certifying. Beyond data and calculation correctness, content validation should also include a review of the branding, layout, formatting, performance, filters, dashboard actions, and edge

case behaviors by the Site Administrator or Project Leader site roles. For more information on content validation, promotion, and certification, see [Tableau Governance on page 79](#).

Visual Best Practices

Visual best practices are key to developing informative visualizations that drive your audience to act. A dashboard is successful when people can easily use it to derive answers. Even a beautiful dashboard with an interesting data source could be rendered useless if your audience can't use it to discover insights.

Think not just as an analyst but also as a designer and consumer. Dashboards should have interactive elements that are discoverable and predictable, follow a sensible, logical layout, and have a simplified design that makes complex decisions easier. It is important not to assume that people automatically know what it takes to clearly and effectively communicate with data. Here are a few whitepaper links to share on your enablement intranet:

- [Visual analysis guidebook](#)
- [Which chart or graph is right for you?](#)
- [Good enough to great](#)
- [Designing efficient workbooks](#)

You can find a list of books by renowned data visualization experts in the appendix. Adding these whitepapers and books to the resources of your analytics community can lead to a deeper understanding and internalization of visual best practices.

Audience

The best visualizations have a clear purpose and work for their intended audience. It's important to know what you are trying to say and who you are saying it to. Does your audience know this subject matter extremely well or will it be new to them? What kind of cues will they need?

Thinking about these questions before you begin designing will help you create a successful dashboard. For example, you would present aggregated, summary-level data and KPIs to an executive audience rather than row-level transactions.

Context

Make sure your views include context. Titles, captions, units, and commentary all help your audience to better understand your data view. Always strive to tell stories with your data and your visuals. Understand that good stories involve more than just data, and consider the following:

- Mind your aesthetics and know that what is effective is often affective. In other words, an effective view can create an emotional response and a genuine communication to your audience.
- Style is also important. Make sure that your views are consistent and pleasing to the eye. Your views are representative of who you are and what you care about.
- Dashboards that people can interact with are very engaging. Interactive elements allow your audience to manipulate the data, ask and answer questions, and arrive at findings on their own. This helps to foster trust in your data.
- Make your views vivid and memorable. Pay attention to structure and context.

Chart Choice

Chart choice should depend on the question you are trying to answer or a specific insight you are trying to communicate. There is almost always a trade-off involved, with different chart types each having their own advantages and downsides. You should always ask yourself if your chosen chart type best conveys the message you are trying to share and if it can be easily understood by your audience. The table below explains the chart types in Tableau's Show Me panel and when to use each. This should be published to your enablement intranet to educate new users.




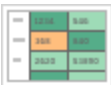
Chart	Description
	<p>Line — Viewing trends in data over time.</p> <p>Examples: Stock price change over a five-year period, website page views during a month, revenue growth by quarter.</p>
	<p>Bar — Comparing data across categories.</p> <p>Examples: Volume of shirts in different sizes, website traffic by origination site, percent of spending by department.</p>
	<p>Heat Map — Showing the relationship between two factors.</p> <p>Examples: Segmentation analysis of target market, product adoption across regions, sales leads by individual rep.</p>
	<p>Highlight Table — Providing detailed information on heat maps.</p> <p>Examples: The percent of a market for different segments, sales numbers in a particular region, population of cities in different years.</p>

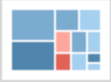







Chart	Description
	<p>Treemap — Showing hierarchical data as a proportion of a whole.</p> <p>Examples: Storage usage across computer machines, managing the number and priority of technical support cases, comparing fiscal budgets between years.</p>
	<p>Gantt — Showing duration over time.</p> <p>Examples: Project timeline, duration of a machine’s use, availability of players on a team.</p>
	<p>Bullet — Evaluating performance of a metric against a goal.</p> <p>Examples: Sales quota assessment, actual spending vs. budget, performance spectrum (great/good/poor).</p>
	<p>Scatterplot — Investigating the relationship between different variables.</p> <p>Examples: Male versus female likelihood of having lung cancer at different ages, technology early adopters’ and laggards’ purchase patterns of smart phones, shipping costs of different product categories to different regions.</p>
	<p>Histogram — Understanding the distribution of your data.</p> <p>Examples: Number of customers by company size, student performance on an exam, frequency of a product defect.</p>
	<p>Symbol maps — Use for totals rather than rates. Be careful, as small differences will be hard to see.</p>

Chart	Description
	<p>Examples: Number of customers in different geographies.</p> <p>Area maps — Use for rates rather than totals. Use sensible base geography.</p> <p>Examples: Rates of internet-usage in certain geographies, house prices in different neighborhoods.</p>
	<p>Box-and-Whisker — Showing the distribution of a set of a data.</p> <p>Examples: Understanding your data at a glance, seeing how data is skewed towards one end, identifying outliers in your data.</p>

Layout

How your audience “reads” your dashboard is not a trivial consideration. Your dashboard’s purpose is to help guide the reader’s eye through multiple views in coordination and tell the story of each insight. Your dashboard needs a sensible “flow” and a logical layout of different pieces of information. The more you employ better dashboard design, your users will discover what’s happening, why, and what’s most important. Consider how you’re guiding their eyes across the dashboard. Are you showing the user where to look next?

Design theory gives us plenty of advice on how best to succeed. Layout is a key component of any successful dashboard design, here are a few concepts you want to think about when building visualizations:

- Newspaper or Z-layout — The most important content is put either at the top or the left of a visualization, as users move right and down for more specific content.
- White space — Using negative space (blank spots) and padding to delineate sections of your visualization – don’t use thick “grid lines” as you would see in a table.
- Size — More important pieces of content (KPIs, summary visualizations, etc.) should be larger than other items.
- Device type — With device-specific dashboards you can create the optimum viewing experience on desktop, laptop, tablet, and phone.

Color

Color is one of the most powerful aesthetic features because it's an attention-grabber. It's the first thing we notice, and it can immediately highlight specific insights or identify outliers, but it is not an unlimited design resource.

Using color effectively is critical for producing quality data visualizations – color types (alerting vs highlighting), creating custom color palettes, and consistency—are key aspects to build into your standards.

The correct use of color is critical for producing coherent and impactful data stories. The key factors that should be taken in to consideration for any successful dashboard are:

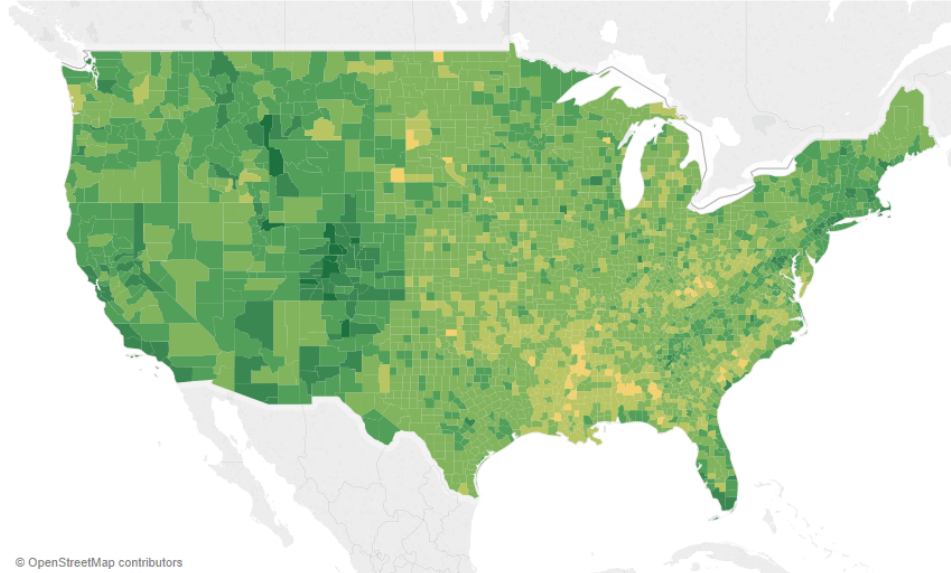
- **Managing color choices** — The primary color(s) that make up most of your design should be a neutral color. Using techniques like grayscale, you maximize the possibility for contrast and visibility of your data driven points. Your extended colors—accents, emphasis, and alerts—should reflect the brand. Any extended color should be used sparingly to draw attention to key messages within the data.
- **Color types** — Understand when to use sequential, diverging, categorical, highlighting, or alerting color motifs.
- **Custom color palettes** — Build your own company palettes to bring a sense of uniformity and provide guiderails for new users.
- **Consistency** — Double-check your visualizations to make sure a color (e.g. red) does not mean three different things. Similar and repeated colors can imply a relation where one doesn't exist.
- **Accessibility** — Remember to account for color blindness in the design process.

Titles & Subtitles

Titles are an easy way to make your dashboard more digestible for your audience. You add more context with subtitles that describe how to interact with the worksheet or dashboard. This is a powerful and simple way to make dashboards easier to navigate. In the example below, the question pulls the audience in and then tells the audience how to answer the question using the dashboard.

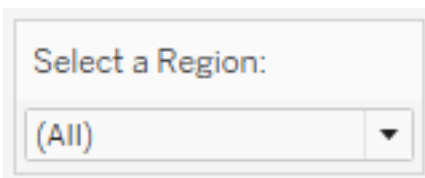
Is Your County Obese?

Select your county to see how it compares with other counties in the country



Effective Title and Subtitle

Similarly, by changing your filter title to something more intuitive, you guide viewers through how to interact with a dashboard.



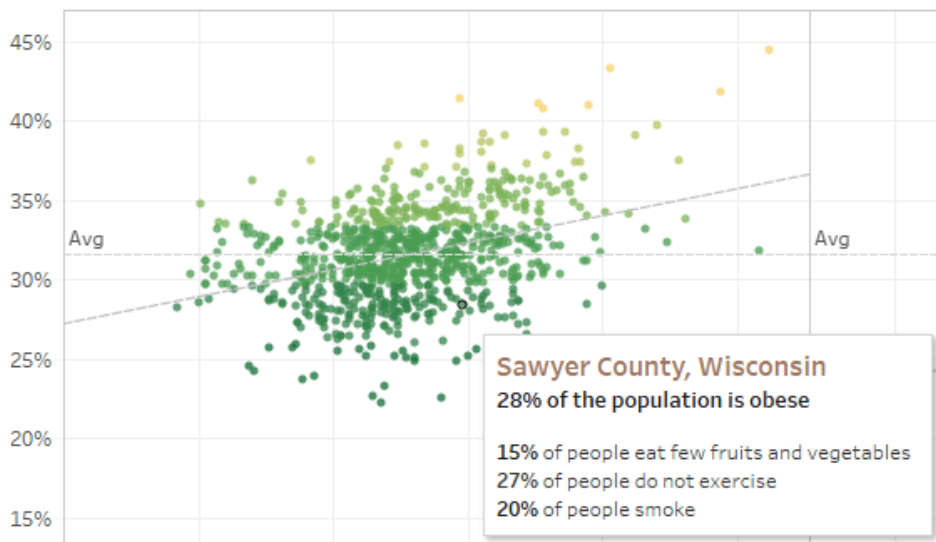
Example of a Filter

Tooltips

Tooltips guide the audience by highlighting important information. In the example below, the County and State are highlighted through a bold effect and color change, and we don't have to partition our scatter plot further. We add important and related dimensions and measures in the

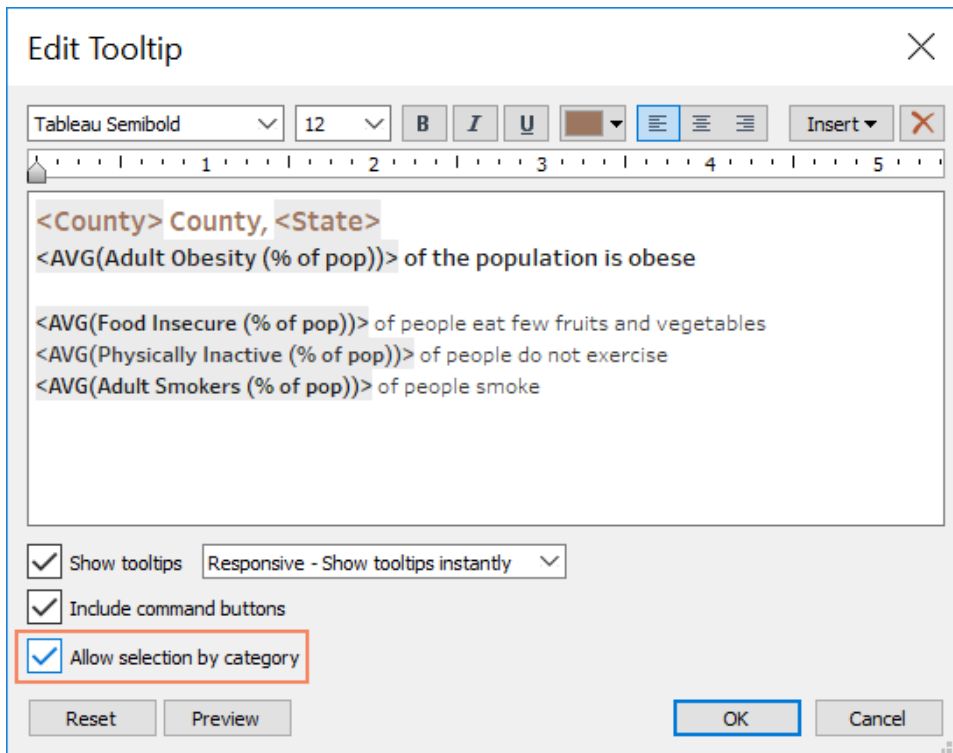
Tableau Blueprint Help

tooltip. This helps save space and declutter the dashboard so our viewers can focus on gleaning insights instead of interpreting the visualization.



Effective Tooltip

If the viewer notices something interesting in the tooltip, they can interact directly with the tooltip and watch the rest of the visualization come to life, highlighting related marks and outliers.

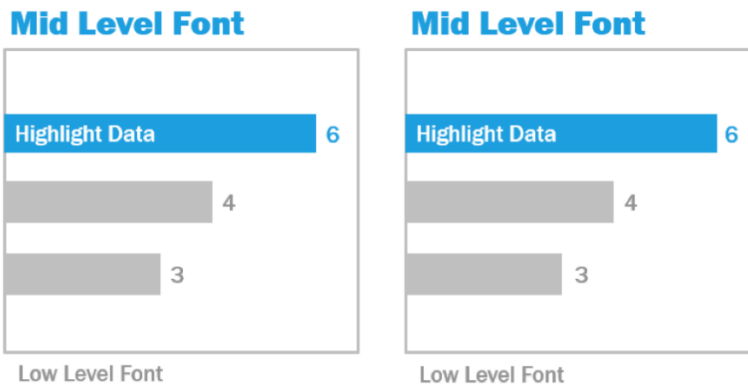


Formatting a Tooltip

Fonts

Typography is important. It can be tempting to use many font types and sizes in a dashboard. Don't do that; instead, define a clear hierarchy for your typography. In the example below, there is a top, mid, and low-level font. The mid-level is blue to focus viewer attention. Color draws the eye to the most important level (which needn't necessarily be the top-level font).

Top Level Font



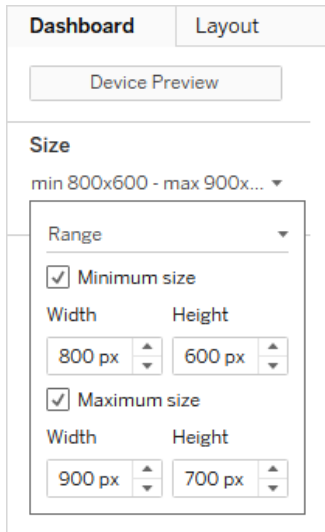
Top, Mid, and Low-Level Fonts (Courtesy of The Big Book of Dashboards)

Make sure that font selection is done to reinforce a visual hierarchy within your visualization through size, boldness, color and type.

- **Size** — Larger elements convey importance as they catch the eye. Save your largest fonts for KPIs, titles, etc.
- **Boldness** — Bolder elements convey importance as they catch the eye. You can vary boldness throughout your visualization in conjunction with size. For example, your title and KPIs could both be 24pt font, but making your KPIs bold will “pop” them, allowing your audience to focus there first.
- **Color** — Generally it’s good to stick with gray and black hues in your titles, text, and KPIs. You can “pop” your KPIs by giving them a color treatment, but you have to balance this with the other colors used in your visualization. Darker colors will draw the eye, so it’s wise to lighten your titles so they don’t compete for visual attention.

Dashboard Size

By default, Tableau dashboards are set to use a fixed size. If you keep this setting, be sure to construct your visualization at the size which it will be viewed. You can also set Size to Automatic, so Tableau automatically adapts the overall dimensions of a visualization based on screen size. This means that if you design a dashboard at 1300 x 700 pixels, Tableau will resize it for smaller displays—and sometimes this results in scrunched views or scrollbars. The Range sizing feature is helpful for avoiding this.



Dashboard Size Range

If you're using Tableau Desktop to create dashboards, you can also design for specific device layouts, so that on tablets, for example, your dashboard contains one set of views and objects, and on phones it displays another. See [Create Dashboard Layouts for Different Device Types](#) for steps.

Dashboard Interactivity

When designing a dashboard, you need to consider your audience, and how you can communicate to them that they can interact with the dashboard. Skilled users know to click and experiment, but new users may not have the knowledge or confidence. Your job is to help them make these decisions consciously, not by accident.

It's important to make any interactivity obvious to your audience—even by creating subtitles to instruct them to click or hover for more information. Add interactivity to your data using filters, tooltips, and [actions](#). Filters are the most obvious way to interact with a dashboard. Users can also interact with your visualizations by selecting marks and hovering to see tooltips. The actions you set up can respond with navigation and changes in the view. The table below enumerates the ways to create interactivity in your dashboards.

Type	Description
Highlighting & Highlight Actions	<ul style="list-style-type: none"> Easily find data of interest while remaining within context. See other marks with shared attributes. Find related data across sheets.

Type	Description
Filtering & Filter Actions	<ul style="list-style-type: none"> • Focus on data you want to analyze. • Control context of data. • Show relevant data and remove unnecessary data.
Parameters	<ul style="list-style-type: none"> • Explore what-if scenarios. • Customize your views. • Enhance dashboard flexibility.
Sets & Set Actions	<ul style="list-style-type: none"> • Dynamically update the members of a set. • Compare parts to whole. • Seamlessly drill down through hierarchies. • Update a calculation by interacting with data.
Tooltips	<ul style="list-style-type: none"> • Provide details on demand. • Keep your dashboard minimalistic. • Insert a viz in a tooltip.
URL Actions	<ul style="list-style-type: none"> • Incorporate external content in a dashboard. • Provide more in-depth information on demand. • Link users to websites.
Dashboard Navigation	<ul style="list-style-type: none"> • Guide users through your workbook. • Direct users to additional content.

When designing dashboards, consider how and why you incorporate interactivity into the dashboard. The following questions are helpful:

- Why does a viewer need to interact with the dashboard?
- What extras insight will be gained through the interactivity?

Designing for Performance

When we talk about **performance**, we mean the speed with which you can work in Tableau. That might mean the speed of data analysis—for example, if you work in Tableau Desktop on a large corporate database that takes forever in real time when you access it remotely. Or it might mean simply the speed of loading views or dashboards that you access on your desktop or from Tableau Server or Tableau Cloud.

Performance and efficiency should be treated as part of the design process—not as an afterthought. Responsiveness is an important success factor for end users when viewing reports and dashboards, so making your workbooks run as quickly as possible makes for happier users.

There are several factors that make a workbook “efficient”. Some of these factors are technical and some more user-focused but in general an efficient workbook is:

- **Simple** — Is it easy to create the workbook and will it be easy to maintain in the future? Does it take advantage of the principles of visual analysis to clearly communicate the message of the author and the data?
- **Flexible** — Can the workbook answer multiple questions the users want to ask, or just one? Does it engage the user in an interactive experience or is it simply a static report?
- **Fast** — Does the workbook respond quickly enough for the users? This may mean time to open, time to refresh, or time to respond to interaction. This is a subjective measure, but in general we want workbooks to provide an initial display of information and to respond to user interactions within seconds.

The performance of a dashboard is impacted by the following:

- The visual design at both the dashboard and worksheet levels, e.g. how many elements, how many data points, use of filters and actions, etc.
- The calculations, e.g. what kind of calculation, where the calculation is performed, etc.
- The queries, e.g. how much data is returned, impact of custom SQL, etc.
- The data connections and underlying data sources.
- Some differences between Tableau Desktop and Tableau Server or Tableau Cloud.
- Other environmental factors, such as hardware configuration and capacity for Tableau Server.

For more information, see [Designing Efficient Workbooks](#).

Accessibility

To make your views accessible to as many people as possible—or if you work in an environment that is subject to US Section 508 requirements or other accessibility-related laws and regulations—you can use Tableau to build data views that conform to the Web Content Accessibility guidelines (WCAG 2.0 AA). This includes building views that are accessible to users who use screen readers, braille keyboards, keyboard-only navigation, and so on. Refer to [Build Data Views for Accessibility](#) for details. Additional resources are available on the “[FAQ: Accessibility](#)” post in the Tableau Community forums.

Organizational Assets

Developing organizational assets—such as a style guide, template workbooks with pre-selected fonts, colors, negative space, etc.—will help your users adopt visualization best practices. It's important for creators and viewers to both understand what “great” looks like and have a common reference on how to best develop, deliver, and consume content. Your community leaders should work on socializing great content across the organization and share any assets on your [Tableau Enablement Intranet](#) on page 277.

By providing users with content that looks and feels familiar, you can dramatically speed up adoption. Additionally, you can build consumer confidence by producing content that is recognizable as part of a brand. The core themes to keep in mind when designing your standard are text, color and consistency.

- Text — Use of text is not limited to **custom fonts**; it is also about the use of text and lettering to enhance your analytics and storytelling to improve cognitive recognition of analytics.
- Color — Use **custom color** palettes, and capitalize on pre-existing associations to increase speed to insight. In addition, keep in mind best practices regarding color-blindness and limit the amount of discrete colors on a dashboard. If your brand has bright colors, use a neutral color palette and use your brand's colors to call out specific items on a dashboard instead of using them for main colors.
- Consistency — Consistency doesn't mean having to have a set of identical visualizations or dashboards. Think about how to convey the same look and feel while allow room for design and creativity.

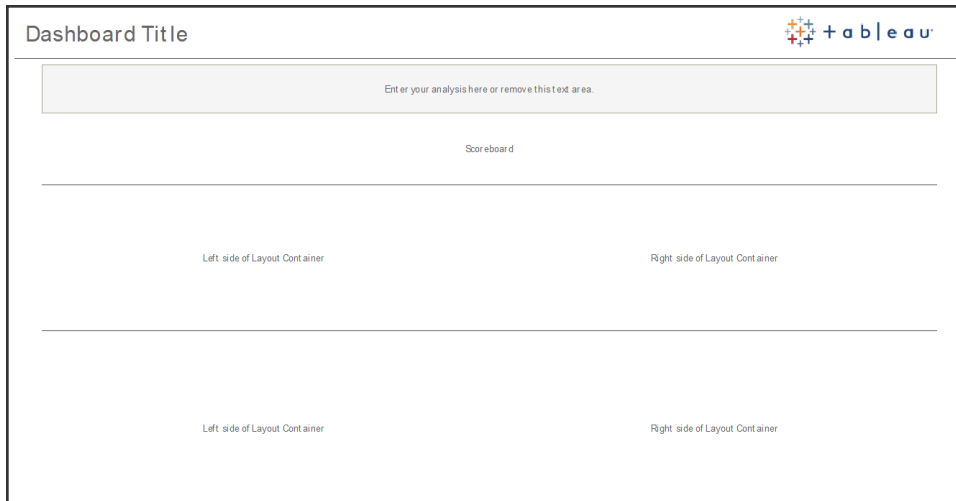
Before creating your corporate-branded standard, remember that you should never compromise efficient analytics for design or stylistic elements. While some design elements can actually increase analytic value, you should never make something that looks good at the expense of performance or functionality.

Visual Style Guide

Do your users know what a great dashboard looks like? By publishing a Visual Style Guide, you will give your users a start on design, as well as guidance on how to differentiate between ad-hoc and certified content, which fonts and brand colors to use, and formatting options. This style guide can be a document or a Tableau workbook.

Dashboard Layout Template

Dashboard layout templates help creators to assemble polished dashboards by adding their individual sheets into predefined layout containers. You can download [sample dashboard layouts](#) from Tableau Public and customize it with your own logo and colors.



Dashboard Layout

Dashboard Review Checklist

You would not distribute documents to stakeholders without the proper review, revision, and release processes, and dashboards are no different. Dashboards need to be reviewed and validated before they are promoted and certified.

The first person to validate content should be its author. Authors should solicit feedback from the target audience as well. This can be done in an informal feedback group or by sharing a link to the workbook and encouraging comments. No dashboard is right the first time. Time and collaboration are ideal ways to hone in on the best representation of your data. Other people's opinions will bring fresh perspectives. Consider the following:

- What type of formal or informal means do we need to gather feedback?
- How can we encourage a constructive conversation?
- Has there been time spent on gathering feedback, improvement, and iteration?

Create a dashboard checklist to help users apply visual best practices and a consistent design with a style guide. Every content creator should apply the checklist of your organizational standards to their work before sharing it with others.

Data Stewards should also play a role to ensure correctness and review an embedded data source as a potential candidate for publishing and certifying. Beyond data and calculation correctness, content validation should also include a review of the branding, layout, formatting, performance, filters, dashboard actions, and edge case behaviors by the Site Administrator or Project Leader site roles.

Metadata Checklist

The metadata checklist below shows best practices for curating a Published Data Source as outlined in [Tableau Governance on page 79](#). By establishing data standards using the checklist, you'll enable the business with governed self-service data access that is user-friendly and easy to understand. Prior to creating an extract or Published Data Source in Tableau, review and apply the following checklist to the metadata model:

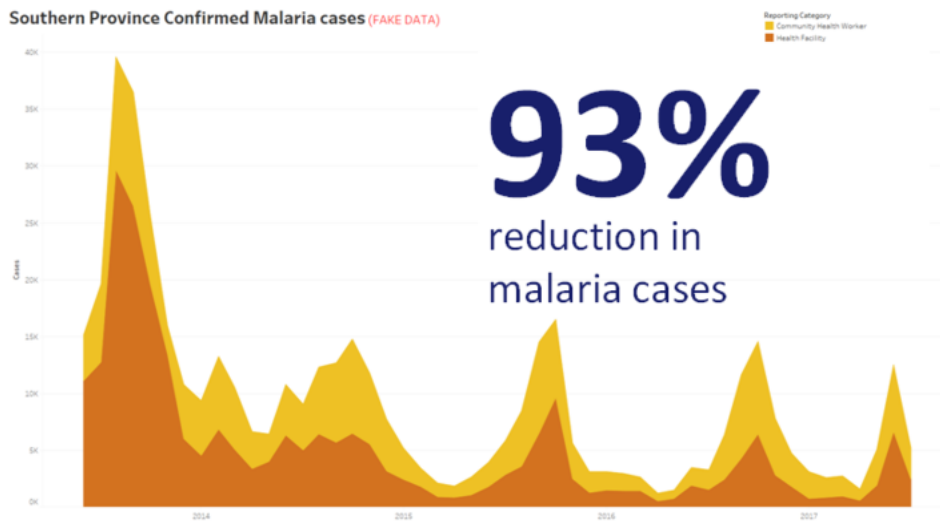
- Validate the data model
- Filter and size to the analysis at hand
- Use standard, user-friendly naming conventions
- Add field synonyms and custom suggestions for Ask Data
- Create hierarchies (drill paths)
- Set data types
- Apply formatting (dates, numbers)
- Set fiscal year start date, if applicable
- Add new calculations
- Remove duplicate or test calculations
- Enter field descriptions as comments
- Aggregate to highest level
- Hide unused fields

Presentation Guidelines

The last mile of analyzing data is taking insight and communicating it to others. Regardless of the data skill level, people should be able to show a dashboard and clearly articulate a data-driven message in a meeting or a presentation. Designing charts for presentation requires special considerations because a complex chart that works for you on your laptop screen won't work in a presentation.

When sharing some insight, consider the key purpose of the chart. What is the main message? In the example below, the charts shows malaria cases in Zambia following work by global non-profit

organization, PATH. The key message is the 93% reduction in cases; notice how that is stamped on the slide very clearly.



Stated Conclusion with Visualization

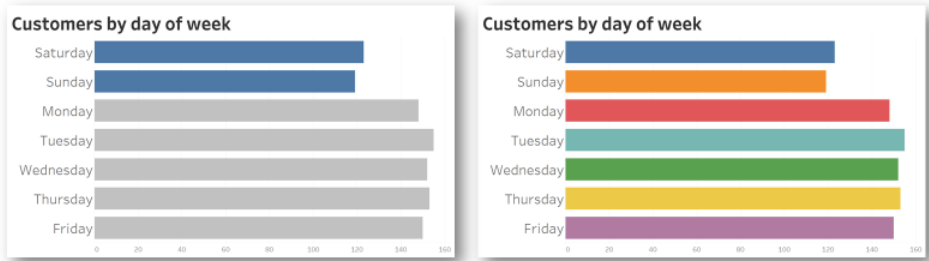
Think about how long the chart will be on the screen for. While you might intimately understand the chart, your audience will be seeing it for the first time. If you want to show a complex chart, you must spend the time explaining it. The malaria example above can be understood in moments because of the visual and stated conclusion. A good rule of thumb is that a chart should be understandable by your audience in less than half the time it is on the screen.

Your audience needs to be able to read the relevant parts of your chart. The font defaults to very small fonts because they are designed for consumption on a laptop/monitor. These font sizes don't work on big screens. Two version of the same chart are shown below. The chart on the right has fonts large enough to be read by everyone in the room.



Legend Incorporated into Visualization

You should use color very wisely to highlight your message. Imagine you are tracking customers by day of the week, and you want to highlight that weekends have far fewer customers than weekdays. The chart on the left (below) most effectively convey that message. It uses a simple color scheme to convey an insight much more clearly than the one on the right.



Color used for emphasis vs. too much color

Before you present your insights in charts, consider the following:

- Have you added state conclusions to tell the story in the data?
- Can the fonts be read from the back of the room you will be presenting in?
- Is color used for highlighting your message rather than decoration?
- Is the chart simple enough to be understood during the time it will be on the screen?

The main takeaway is an appreciation that a dashboard or complex analytical chart, designed for desktop screens are almost never the appropriate choice when sharing insights in meetings or presentations.

Tableau Communications

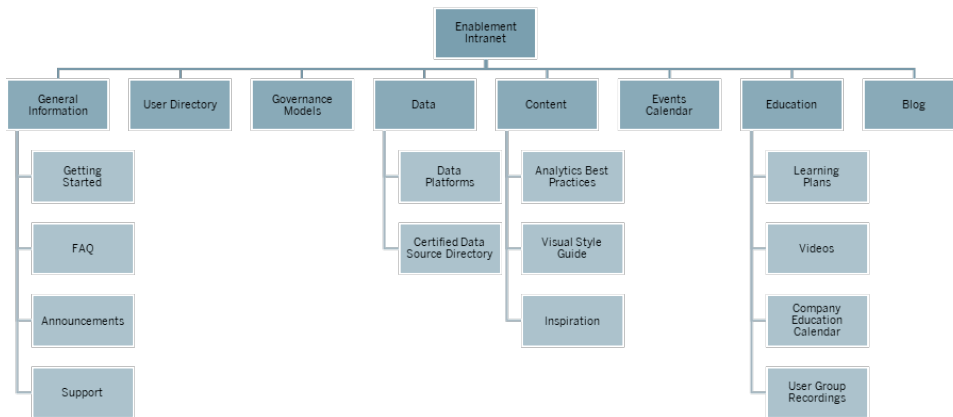
When you deploy Tableau broadly across your organization, establishing internal communications and enablement resources promote adoption to scale data and analytics more efficiently. Our most successful customers use a variety of self-service help methods to get started with Tableau, answer frequently asked questions, and locate other Tableau users within the company.

This topic outlines the enablement intranet, discussion forums, and newsletters to assist the analytics sponsor and community leader. Depending on what works best for your company, the list of topics below showcases the many ways you can communicate with your user community. With a well-defined communications plan, you will build your user community, nurture the use of data and analytics across all skill levels, and minimize the resources needed to answer common questions.

Tableau Enablement Intranet

As your deployment grows from hundreds to thousands of users, it can be difficult for users to connect with one another. The enablement intranet allows numerous users to connect across departments and geographic locations. It will serve as the hub for all Tableau resources with the goal of creating a consistent user experience and helping everyone form new habits based on best practices.

The following sections define topics you can publish on your intranet that will allow your user community to quickly and easily find information about onboarding, governance policies and procedures, other Tableau users, and more. By sharing this information proactively, you'll get ahead of the questions and lower the barriers to providing governed, self-service analytics. An example site map is shown below:



Getting Started

When a new user is interested in a license, who do they contact? What do they need to know to start using Tableau? What resources are available? As Tableau is deployed broadly across your organization, if you're the only one trying to onboard every user, there will be trouble ahead. As more users adopt, it becomes more difficult to effectively manage and support the user community because there aren't enough resources to provide one-on-one assistance.

The "Getting Started" area connects new users with necessary resources on your intranet and throughout the company. Get users over the hump, and onto using Tableau, instead of struggling. This is the first step to empower users and build your organization's Tableau community.

Think of the common questions you might get:

- How do I obtain a license and install software or access Tableau Server or Tableau Cloud?
- What are the basic skills for each license level? (detailed below)
- When is training and what is needed for my corresponding role?
- Who is using Tableau in my department?
- How do I connect to data?
- What certified data sources are available?

Additionally, publishing links to Tableau's Online Help topics will help to set the baseline skills for viewing and interacting with data:

- [Sign in to Tableau Server or Tableau Cloud](#)
- [What can I do with a Tableau site?](#)
- [What can I do with a Tableau web view?](#)
- [Explore and analyze data in a view](#)

Tableau Blueprint Help

- [Use custom views](#)
- [Share web views](#)
- [Subscribe to views](#)
- [Send data-driven alerts](#)
- [Comment on views](#)

For Creators and Explorers, provide the following links:

- [Web Authoring and Tableau Desktop Feature Comparison](#)
- [Creators: Get Started with Web Authoring](#)
- [Creators: Connect to data on the web](#)
- [Prepare Data on the Web](#)
- [Edit Views on the Web](#)
- [Connect to published data sources while web editing](#)
- [Create a Dashboard](#)
- [Create a Story](#)
- [Save your work](#)

FAQ

Maintaining an FAQ will help users quickly and easily answer common questions, as well as save you time from not having to directly respond to every question. In the event where a [Data Doctor program](#) is implemented in your organization, consider tracking the number of questions asked and what topics are most often covered. Tracking this information will help you identify common topics and categories for questions, and what training should be given to fill those knowledge gaps. We recommend encouraging your readers to provide feedback on your most common questions, whether by enabling feedback on articles, suggesting edits via a specific chat channel, or by emailing a specific distribution list.

Support

In the support area, define where a user should go for assistance, including [Peer-to-Peer Assistance on page 302](#), office hours, and logging a support ticket. If a user cannot find the help they need, then they are more likely to become frustrated with the situation and not continue using Tableau. Establish and document an escalation path for tickets in case a question cannot

be answered by an expert within the user's team or department. For more information, see [Tableau Support Processes on page 297](#).

When enabling peer-to-peer support, encourage one and other to learn, teach, and discover solutions together. Knowing [how to search efficiently using Tableau search engines](#) is a fast and easy way to often move past a technical roadblock.

You should also take advantage of Tableau's online Help and Knowledge Base by publishing links to common help support topics: [Tableau Desktop](#) and [Tableau Prep Builder](#). On these pages, you'll find a list of popular topics that you can curate on your enablement intranet's support page.

Announcements

Post announcements on the enablement intranet to communicate everything from user group meetings, learning plans, training opportunities, and office hours to maintenance windows, upgrades, and other service-impacting events.

User Directory

Creating a user directory makes people discoverable, promotes the exchange of ideas, helps users find others in or outside of their team for assistance, and builds your user community. The user directory should include every licensed Tableau user, with their name, department, title, license level, skill belt level, and certification level.

Licensed Tableau users can be obtained from the Tableau Server Community TS Users Data Source and joined with HR, training, and certification data to provide a complete profile of each user. Alternatively, the [Tableau Users on page 56](#) tab of the [Tableau Blueprint Planner](#) will also include this information and can be used as the data source to create the list. Use Tableau to create the view and embed it in the web page.

Governance Models

Combining people, process, and technology, it is informed users who put your company's [Tableau Governance Models on page 114](#) into practice. Help your users understand the centralized, delegated, and self-governing models of data and content governance, which were established with the Tableau Blueprint Planner's Governance Worksheet, by publishing guidelines, policies, and processes. Users need to understand and reference your

organization's workflow regarding data source certification and content promotion for everything from sandbox to production projects.

Data Platforms

Your company's sources of data should be listed so that users know where to go for what kind of data. Document the database name, table or view, type of authentication, and access request requirements on each one.

Certified Data Source Directory

To help users understand what trusted data is available to them and more quickly find a governed dataset for their analysis, create a certified data source directory. The Certified Data Source Directory lists curated, governed data sources. It should include the data source name, owner, and source of data at a minimum. Since one department's data can be helpful context for another department, consider sharing all certified data source names to the directory to increase awareness around availability while also minimizing the possibility of duplication.

Certified Data Sources can be obtained from the [Tableau Server Community TS Data Connections](#) Data Source by filtering on [Data Source is Certified] = TRUE. Use Tableau to create the view and embed it in the web page.

Analytics Best Practices

With analytics best practices readily available on the enablement intranet, content authors will have guidelines for choosing the right chart type and creating effective, actionable dashboards for content consumers. For more information, see [Analytics Best Practices in Tableau on page 251](#).

Visual Style Guide

Do your users know what a great dashboard looks like? By publishing a Visual Style Guide, you will give your users a head start on design, as well as guidance on how to differentiate between ad-hoc and certified content, which fonts and brand colors to use, and other formatting options. Often the best place to start defining a visual style is your corporate brand or style guide. Post a [custom color palette](#) and layout template in this area. For more information on branded layout templates, see [Analytics Best Practices in Tableau on page 251](#).

Inspiration

You can embed Tableau RSS and/or Twitter feeds in an intranet page to deliver current content directly from Tableau to your user community. Tableau provides an RSS feed for the Tableau Blog, which can be consumed with an RSS viewer web component. Separately, Tableau provides an email subscription service for Tableau Public's Viz of the Day Gallery. Tableau (@tableau) and Tableau Public (@tableaupublic) Twitter feeds can be embedded on your intranet by using [Twitter's embedding page](#).

- Viz of the Day: [Gallery](#), [Email](#), [Twitter](#)
- Tableau Blog: [Website](#), [Email](#), [RSS](#)
- Tableau: [Twitter](#)
- Tableau Public: [Twitter](#)

For the latest and greatest content in data visualization, join the [#datafam](#) by following [Tableau Visionaries](#) and [Ambassadors](#) on twitter.

Events Calendar

Building an events calendar based on engagement activities outlined in [Tableau Community Engagement on page 287](#) and [Tableau Support Processes on page 297](#) can assist your users with engagement and adoption. These activities include user group meetings, admin group meetings, lunch-and-learn events, and office hours.

Learning Plans

To help users understand the skills needed for their job function and license type, publish learning plans for each of the roles: Site Admins, Project Leaders, Creators, Explorers, and Viewers. For more information on learning plans, see [Tableau Education on page 215](#).

Data Literacy Resources

Provide resources on foundational data literacy skills to enable anyone in your organization to establish a baseline of data literacy. Include links to our [Data Skills 10 Million](#) page, where we offer two free resources as part of our [#PledgeforData](#) -- a pledge to champion data skills and train 10 million people!

Company Education Calendar

The company education calendar has recurring meetings for Site Admin-, Project Leader-, Creator-, Explorer-, and Viewer-focused training sessions that will be held in a web meeting or a classroom. Holding these sessions monthly or even weekly, especially starting out, will provide everyone with the information they need to begin using Tableau. For more information, see [Tableau Education](#) on page 215.

User Group Recordings

By recording your internal user group meetings, you can make them available to anyone who was unable to attend in-person. They can serve as a useful reference for training new users as well.

Internal Tableau Blog and Newsletter

Want to stay on top of the latest from Tableau? Head to [Tableau Blog](#), then enter your information and hit Subscribe at the bottom of the page.

Publish an analytics blog to showcase achievements and provide awareness and recognition of how data and analytics are used within your organization. Departments can submit highlights of their work and upcoming events can be promoted. Other topics might include documented value, Tableau tips and tricks, enterprise-scope data source availability, and communication of downtime/upgrades. Alternatively, you can distribute an analytics newsletter via email.

Tableau Discussion Forums and Chat

Discussion forums and other chat-based communications provide users with information in real time. These methods can also become a knowledge base as archived chats may answer questions that will arise in the future. Set up a Tableau discussion forum, chat room, and/or channel (Slack, Yammer, Wechat, etc.) and invite all your Tableau users to join.

Depending on the systems used by your company, both discussion forums and chat are incredibly helpful to community managers to determine topics that may need more attention in training or with engagement activities. In forum-style discussions, questions and answers can be categorized by topic to improve future searches. For channel-based communications, you can achieve a similar result with a channel per topic or a single help channel for all questions. Either way, facilitating these connections between users will make your community stronger.

Getting Started

Building your own community spaces can be challenging, but once started, it will serve as a virtual rallying point for your users. The below methods can be used to help you set yourself up for success:

- **Community Champions:** A committee or team of Tableau experts can be a voice for your users and shape the way your forums are setup based on their needs. Keeping this group diverse will ensure you plan for the needs of all your users.
- **Types of Resources:** Which topics are most important to your users? How do they prefer to consume content? What is the frequency at which you should deliver content? Answer these questions can get you started on creating content that is right for your user base. Your community champions should be involved in this planning phase.
- **Encourage self-service help:** A key benefit of community spaces is the ability for users to solve their own problems and issues through the expertise of others. By setting service level agreements on response times to chat messages or posts you can give your community users confidence that they will not go unheard.
- **Roles & Responsibilities:** A successful community can quickly grow to touch all aspects of an organization. Make sure the roles of the team who will be managing your internal forums are clearly defined. Examples of discussion forum and chat roles are:
 - **Admins:** monitoring the overall health & performance of the forums
 - **Moderators:** answering questions and engaging with forum users
 - **Ambassadors:** those who serve as champions and face of the forums
- **Be Realistic:** Set expectations for your forums early in terms of engagement, what types of content you will need, and who owns what.
- **Start Small:** Build for what you need and plan for the future. Your forums may start small, but they won't stay that way.

Building Your Forum

When setting up your own forums and chat spaces, keep in mind some of the below best practices:

- **Platform:** Look to company standards for chat- and intranet-based applications that work within your organization. This can be anything from your [Tableau Enablement Intranet on page 277](#) to a chat-based application. The important thing is that your users know where to go to connect with other Tableau users, outside of regular [Internal Tableau Activities on page 287](#).

- **Easy to find resources:** Create distinct spaces for your users to quickly find resources such as getting started with Tableau, advanced calculations, and employees who can offer guidance. Setting these spaces up early and populating them with content will keep your users coming back to your internal spaces.
- **Categorization:** Setup chat channels or tag forum posts with specific topics to improve content searchability. As your community grows, so will the content. Make sure your users can quickly and easily find what they need.
- **Internal Moderators:** Identify a group of power users who can help moderate the forums by answering questions, creating content, and onboarding new users. These individuals should also be Tableau experts who can help guide your users through even the most challenging asks.
- **Use the data:** Keep track of how users are interacting with the forums and what topics are most popular. This will guide you in developing the right content and forum engagement plans for your users, as well as identify content for regular [Internal Tableau Activities on page 287](#).

Through careful planning, your discussion forums and chat spaces can become a tremendous resource for driving adoption of Tableau within your organization.

Chat

Take the time to research, identify, and implement the chat platform that answers most of your company's business needs. Once identified, we recommend:

- Creating two chat rooms or channels dedicated to enablement: one for announcements (future events, deployments, maintenance), and one for your users to ask their Tableau questions.
- Have clear guidelines for engagement to redirect and train your users on how to ask questions or where to find training resources or FAQs.

For more information about how to transform your chat experience and integrate it with your Data Doctor program, see the [Data Doctor Implementation Toolkit](#).

Learn from Tableau

Leverage the Tableau Forum resources below for inspiration on how you want users to interact with your forums and the types of guides you can create:

- [Tableau Forum Guidelines](#)
- [Attaching a workbook](#)
- [@ mention etiquette](#)
- [Community Etiquette](#)
- [Code of Conduct](#)

Tableau Community Engagement

Your organization's Tableau user community is just like the Tableau Community—only on a smaller scale. You should connect users within your company and generate enthusiasm among a group of people founded on the common cause of putting data at the center of every conversation. While building excitement around the use of Tableau, engagement activities accelerate and reinforce the vision for modern analytics, and ultimately, fuel your organizational transformation.

Engagement activities are used to create and nurture an environment for more productive, results-driven people who will use facts over intuition to make business decisions. People will collaborate with each other and share their product knowledge and business domain experience across a wide-range of skill levels and across different teams and departments, who may never have exchanged ideas before.

Engagement activities should include something for everyone, offering a variety of activities that appeal to different skill sets and are delivered through different formats from in-person to virtual, both inside and outside your company. Whether hosted by your company's community leader, other Tableau customers, or Tableau Visionaries and Ambassadors, there are a variety of formats to invite users to learn, collaborate, and network to increase their Tableau skills.

Internal Tableau Activities

Hosted within your company, internal engagement activities are organized by a Community Leader, following a regular schedule or events calendar that is published on your enablement intranet or wiki and promoted through other communication channels. The following activities will be covered in this section:

- User Group – open to all Tableau users to promote collaboration and sharing between teams
- Champions Group – open to all identified champions to exchange ideas
- Admin Group – open to all Tableau Server and Site administrators to review server and content usage and exchange administration ideas
- Lunch & Learn – lunchtime meetings focused on building a new skill
- Viz Games – data-analysis competition
- Tableau Day – full- or half-day event to share Tableau successes
- Analytics Day – similar to Tableau Day, but broadened to include other technologies

Tableau User Group

Internal user groups can take different shapes depending on your organization's size and geographical distribution, but one thing is certain—every Tableau user is invited to participate. This also includes Server and Site Administrators. It may start with just a few people, or it could be hundreds across the organization. During user group meetings, people can openly share information across different teams and departments. Regardless of skill level, it's a great way for everyone who attends to learn, network with other users, and exchange fresh perspectives on solving business problems with data.

A strong internal user group starts with a strong leader. It is their passion and attention that will fuel and inspire the rest of the group. The community leader should schedule a regular, recurring monthly meeting time, and promote it on the enablement intranet. Don't be discouraged if attendance numbers aren't high initially. When relevant topics are put on the agenda, people will attend because they know valuable information will be shared. If possible, record the meetings and archive presentations on the enablement intranet so that new users can benefit from on-demand viewing. A sample user group agenda is shown below:

Topic	Description	Duration
Welcome/announcements	Welcome attendees and share announcements such as new help topics on the intranet, training sessions, etc.	10 min
Skill development	Select a topic to help attendees learn a new skill, such as product skills or demonstrate design best practices from internal or Tableau Public content.	15 min
Success story	Share an achievement that was made by using data.	10 min
New certified data sources	Highlight new certified data sources that have become available because one department's data can add context to another's.	5 min

Topic	Description	Duration
Top content recognition	Showcase the top 10 dashboards in the company.	5 min
Open feedback	Allow time for open feedback and Q&A.	15 min
Total		60 min

Meeting topics should be tailored to suit users' needs. Information gathered from the Data & Analytics Survey and Users tabs in the [Tableau Blueprint Planner](#) will provide initial guidance on what skills exist versus which skills need to be developed among the user community.

For existing deployments, Tableau Server and/or Site Administrators will be able to provide more information about user behaviors from the Tableau Server Repository. Tableau Cloud Site Administrators will use Admin Insights. Examples include content utilization and the availability and use of published and certified data sources, subscriptions, and data-driven alerts, as outlined in [Tableau Monitoring on page 183](#) and [Measurement of Tableau User Engagement and Adoption on page 233](#). For instance, if there are only a few Certified Data Sources available, you can hold a session on how to publish and certify data sources and discuss the value of the curated, governed data models. Similarly, if users are not subscribing to dashboards or setting data-driven alerts, you can encourage users to take advantage of these features by explaining how to subscribe or set an alert. For more information, see [Tableau Community Toolkit](#).

Tableau Champions Group

Champions are part of a program to recognize people in your analytics community who heavily contribute by connecting, collaborating, and sharing with others because they recognize the value of helping their peers see and understand data. Characteristics of a champion are listed below:

- Leadership and Evangelism
 - Represents the spirit and voice of the community: inclusive and kind.
 - Teaches by their actions and encourages good behavior within the community.
- Knowledge and Advocacy
 - Has a fair understanding of the Tableau product, company, and/or community.
 - Is active in the community.

- Responsive and Accessible to others in the community
 - Responds and engages with others regularly in regards to Tableau.
 - Collaborates and contributes where possible.

Champions should meet as a group to share what they are hearing and seeing from users to feed into community-wide, enablement activities, representing the Tableau community within your organization.

Tableau Admin Group

The admin group is a subset of the user group, consisting of Tableau Server/Site Administrators and/or Tableau Cloud Site Administrators. Admin group meetings should occur monthly to exchange ideas, share challenges, and identify how changes will be communicated. In organizations with multiple Tableau Server instances and/or Tableau Cloud Sites, having an Admin group will help to coordinate standards and processes, as well as tackle common challenges. A sample administrator group agenda is shown below:

Topic	Description	Duration
Welcome/announcements	Welcome the admins and share announcements.	10 min
System Utilization Review	Review system utilization, background tasks, user onboarding schedule.	15 min
Content Utilization Review	Review content utilization, slow-loading dashboards, long-running extracts, stale content.	20 min
Open feedback	Allow time for open feedback and Q&A.	15 min
Total		60 min

Tableau Lunch & Learn

It's often challenging to schedule time during a busy workday, but everyone has to eat. Lunch-and-learn events are an informal option to help users learn from each other. Schedule a monthly, lunchtime meeting where people can bring their food in and listen, or if possible, even arrange for food to be brought in. This will definitely increase your attendance rate.

Tableau Viz Games

Viz Games is a visualization competition where a sponsor issues a visualization challenge, a data set prepared for analysis, and a deadline for publishing submissions, typically one week or more into the future. Live contests, where contestants compete in a race to submit visualizations before the clock runs out, are exciting, but more complicated to run. At Tableau, both formats are used. The online contests determine who is eligible to compete in the final, in-person contest.

Selecting a theme up front helps guide the rest of the competition. Themes for viz competitions are typically around a particular topic, dataset, chart/dashboard type, or feature. Get creative and challenge the participants in a way that is fun and engaging!

Executive sponsors may tie the contest back to a strategic initiative to motivate contestants around a common cause or business problem. Allow cross-functional teams to form and solve the problem by bringing together a Tableau champion, a data expert, and a business domain expert. For example, the company has a \$45 million savings target. Finance provides Accounts Payable data and contests are asked to design a dashboard to identify potential savings areas.

Judging panels can be a group of people with diverse experiences and perspectives to make for a balanced evaluation. The panel should evaluate submissions on the following areas:

- Analysis – Review the question(s) that are being asked and the insights the viz provides. In more detail, look at the type of data used, the type of charts used, the type of aggregation and statistical analysis used. How sophisticated and appropriate for the story, or question being answered, are these analyses?
- Storytelling – See whether the context of the topic and questions being posed are clear. Is it clear how one moves through the viz and from question to answer? Does it highlight what is interesting and why it matters? All of that can be done in different ways, using color/shape/size, text, images, annotations, story points, etc.
- Design – Evaluate the visual appeal, layout and flow, use of whitespace (or lack thereof), and colors and images. How polished is it? How appropriate is the design for the story that is being told?

Use a scoring sheet to record values and feedback:

Viz and Link Analysis (0-10) Storytelling (0-10) Design (0-10) Feedback

Recognition, no matter how small, is motivating. Give out prizes for simplicity, for guided analytics, for creativity, and even for obscure insight. For more information, see [Tableau Community Toolkit](#).

Tableau Day

To raise the visibility of data and analytics within your company, schedule a Tableau Day one or two times a year. The event can be like a miniature Tableau Conference for your company where presenters share their work and insights. Coordination with executive sponsors to speak about achievements made on strategic initiatives is a great way to emphasize the transformational power of data and analytics.

Another activity to add to your Tableau Day is a [Data Doctor](#) practice. Data Doctor helps your data enthusiasts remove each others' roadblocks and learn best practices, all by leveraging volunteer Tableau experts from your own organization.

Tableau can provide speakers who lead the attendees through demos, hands-on training, and Q&A. Having a Tableau resource onsite—or more than one—is a guaranteed way to attract other users. Working with your Tableau account manager to set up a Tableau Day is a fantastic method to generate excitement and build momentum across the organization.

Analytics Day

An Analytics Day is similar to a Tableau Day, but the scope expands to include subjects other than Tableau. Expanded topics like systems modernization and database platforms can be combined with Tableau content for a broader showcase of the use of analytics and advances being made with data.

Tableau Blitz

It happens to everybody: questions pile up in your discussion forums because not enough responders with the right knowledge are available to lend assistance.

To quickly clear the backlog, schedule a “Tableau Blitz,” a day or week when champions will dedicate time to resolving unanswered questions in your discussion forums. Work with executive sponsors to thank champions for volunteering their time to participate.

External Tableau Activities

External activities, outside your company, are organized by Tableau or Tableau Community leaders. You should encourage users to attend these activities as well. For a full list of scheduled community events, visit [Events and Conferences](#). The following external activities are covered in this section:

- Area Tableau User Group – customer-led sessions held in major cities around the world
- Virtual Tableau User Group – online meetings hosted by customers or Tableau
- Tableau Public Virtual Challenges – community-led programs with a skill-building focus
- Tableau Community Forums – places to join discussions, browse topics, ask questions, and share insights
- Tableau Roadshows – Tableau-hosted events in coordination with product launches
- Tableau Conference – annual customer conference held in both the US and Europe
- Iron Viz - Tableau’s annual data visualization contest

Area Tableau User Group

A [Tableau User Group](#) is a customer-organized event that creates a place for users to learn, collaborate, and network. With over 250 worldwide, Tableau User Groups are organized by geographical regions and are most commonly held at office spaces or universities. Hosting a Tableau User Group is beneficial to both the host and attendees—it’s free onsite training for employees and great exposure for creating visibility in the community!

Virtual Tableau User Group

[Industry user groups](#) are often run by customers. Here, more people are able to connect with their peers in 14 active industry groups: Server Admin, Healthcare, Government, K-12, Law, Retail, Data + Women, Nonprofit, Insurance, Higher Education, OEM Partners, Travel & Hospitality, Manufacturing, and Loss Prevention.

Tableau Public Virtual Challenges

All Tableau users should consider joining [Tableau Public](#), a free platform that allows you to explore, create, and share interactive visualizations using publicly available data online. That last part is important. Make sure the data you share on Public is, well, available for public consumption.

Using Tableau Public to participate in Tableau Community-hosted events provides anyone that's using or learning Tableau with valuable practice and a large community to learn from and network with. These events, run by [Tableau Community Leaders](#) and [Tableau Visionaries](#), inspire others, demonstrate different ways to solve problems, and offer different perspectives for applying Tableau. This is in no way meant to be an exhaustive list of Data Fam challenges:

[Makeover Monday](#) helps you improve your data visualization and analysis skills by exploring different perspectives and approaches to a data visualization. With participants from around the world, Makeover Monday is a weekly learning and development session hosted by Tableau Community Leaders and Visionaries. Every Monday, participants start with a given data set and create better, more effective visualizations. Consider time-boxing yourself to one hour, just to make something quick.

[Workout Wednesday](#) will help you grow your Tableau skills by testing your knowledge of Tableau. Participants in these weekly challenges are asked to replicate the challenge as closely as possible. When you think you have it, leave a comment with a link to your visualization, and post a pic on Twitter for others to enjoy. You should aim to complete challenges within one hour, and solutions are provided for all challenges if you get stuck.

For more information and a more extensive list of Tableau Community-hosted virtual challenges, check out [Tableau Public's Community Resources](#) page.

Tableau Community Forums

The [Tableau Community Forums](#) is a place to get your Tableau questions answered, collaborate with others and a space to help you get the most out of Tableau. Have a question or want to help other users? [Explore the Forums](#) – every day, customers and partners are discussing best practice, helping other users and working together. You can also [connect with other users](#) in your industry, region or role across various Community User Groups to drive better analysis and collaborate. Finally, we want you, our Community members, to determine the future of Tableau by browsing [product Ideas](#) and upvoting ones you would like to become part of the product.

Tableau Conference

Customers come to [Tableau Conference](#) to learn how to be faster, gain inspiration, network with other attendees, and build lasting connections. Whether you're new to data analytics or a seasoned pro, Tableau Conference has the content you need to kick your skills into high gear. From lectures and hands-on training to collaboration sessions, meetups, and Tableau Doctor appointments, Tableau Conference has something for every learning style, including Tableau- and customer-led breakout sessions, training workshops, and certifications. The events are held in the US (Tableau Conference) and Europe (Tableau Conference Europe) annually. Join the conversation about Tableau Conference in this [user group board](#) in the Tableau Community Forums.

Iron Viz Competition

[Iron Viz](#) is Tableau's own data visualization contest, giving you the opportunity to compete with data rockstars from around the world. The winners of a series of topic-themed virtual qualifier competitions determine the finalists who advance to a live on-stage championship at either Tableau Conference Europe or Tableau Conference. Find out about the schedule and more [here](#).

Tableau Support Processes

If you need to open a case with Tableau Support, follow the steps in the [Submitting a Case From the Webform](#) Knowledge Base article.

In addition to the proactive steps you've taken with self-service help resources and education initiatives published on your enablement intranet, your user community should be able to request more support in case these two approaches do not answer their question or resolve the issue. If a user cannot find the help they need, then they are more likely to become frustrated and abandon Tableau, which will negatively impact adoption targets.

Like other enterprise platforms, you should define the support escalation path for Tableau, considering the next levels of support that will be available and which team will be responsible for the resolution. Customers have successfully established community-led support by using champion-created content, and escalating to the analytics or IT team for system-level issues, such as server and database access. Log and categorize these requests to analyze the support data and identify opportunity areas for new content on the enablement intranet, user group topics, and educational needs. An example of an **internal** support escalation path is:

- Department or team champion
- Channel-based communication or chat
- Data doctor office hours
- Analytics support ticket

Additionally, there are a number of [self-help resources](#) are provided by Tableau:

- [Knowledge base](#) with step-by-step instructions to resolve problems
- [Tableau Community](#) forums to find answers from other Tableau users worldwide
- [Support hub](#) with alerts, drivers, release notes, known issues, and FAQs
- [Tableau Trust](#) for status of the Tableau Cloud and Tableau Public
- [Twitter support](#) with updates trending technical support issues, popular KB articles, and more

Through a variety of interactions, you need to support your user community, encourage collaboration, and remove the obstacles to using data and analytics effectively. This document outlines the tactics to develop Tableau champions, connect people with peer-to-peer assistance, and define the support escalation path.

Tableau Champion Development

Across your organization, there are people who believe in the transformational impact of data. They want to put data at the center of every conversation and business decision, and are motivated to develop their skills and support others by sharing their knowledge. A Data Champions program identifies and elevates these users, helping them realize their greatest potential while also enlisting them as leaders, teachers, and advocates of data culture in your organization's community. You'll invest in identifying and developing these champions, and as a result, you'll have an extended network of Tableau enthusiasts. This is vital for your adoption process because as your deployment expands to new departments and teams, new champions will need to be developed to scale your analytics practice. Champions reduce the dependency on a centralized support team, as well as:

- Model data-driven decision making to their colleagues;
- Make connections between users and create opportunities for cross-functional collaboration;
- Support users by sharing their expertise;
- Evangelize and participating in community activities;
- Inform community and proficiency efforts with experiences from the front-line;
- Capture use cases and identify examples of excellence.

No two Data Champions programs will look the same, just as no two communities will look the same. Just as with other efforts in Tableau Blueprint, you'll have to assess this program in the context of the scope, size, maturity of your organization and its analytics community. You can [explore example use cases](#) (PPTX), inspired by real customer Data Champions programs.

Data Champions Program Foundations

Before you get started, you'll need to decide if you're prepared to run a formalized Data Champions program. Ensure you have the following:

- **Strategic Plan for Community:** A Data Champions program is not a replacement for your organization's user onboarding or other community efforts. Champions are one piece of your community strategy, and should be focused on accelerating and amplifying your communications, your engagement activities, and your processes for supporting users. For more information, see [Tableau Community Planning on page 56](#).
- **Dedicated Program Leader:** Make sure you have a program leader who can own the program from start to finish. Your program leader will likely be your Community Leader or

another member of your core project team. For more information about the Community Leader and other common roles in a Tableau Project Team, see [Tableau Project Team Roles and Responsibilities](#) on page 72.

- **Established Communications Platform:** You'll need a consistent and centralized platform to communicate with your champions and to facilitate conversations between them. For more information, see [Tableau Discussion Forums and Chat](#) on page 283.
- **Executive Sponsor:** Align your Data Champions program to an executive sponsor who has the ability to recognize participants and make other organizational leaders aware of their outsized contributions to the community.

You'll also need to spend time identifying the purpose of your Data Champions program for your organization. There are many business needs a Data Champions program can address, but most are captured in one of two overarching goals: Engagement and Enablement. Once you have identified business needs and the overarching goal for your program, tie it back to some measurable success metrics found in [Measurement of Tableau User Engagement and Adoption](#) on page 233. This will help show value of your program, and help your champions see their impact.

Goal	Business Need	Success Metric
Engagement	We have some great dashboards, but they aren't being used.	Improve active users by 10%
	We host User Groups and other community activities, but they aren't well attended.	Increase attendance at User Groups by 10%
Enablement	We offer product training, but this doesn't help users get to know how we use data at our organization.	Reduce support tickets by 10%
	We have an internal forum, but we cannot keep up with the volume of posts.	Reduce unanswered posts by 10%

Designing a Data Champions Program

You have the foundation in place for running a Data Champions program and have identified its purpose. Next, you'll need to design a program that will help you meet your goals. Use the following template to help you define, develop, and reward your champions:

1. To help us meet our goal, we want our champions to _____.
2. We will help our champions meet these expectations by _____.
3. We will reward their efforts with _____.

Defining Champions

What does it mean to be a champion at your organization? Do they help you plan and execute engagement activities? Should champions be actively supporting their colleagues, whether in person or through an internal forum? Think about the characteristics of a champion as well as what you want your champions to do. Ensure you are clear on the scope and responsibilities needed to fulfill the role, obtain management approval for the time champions are committing, and ensure that your expectations for champions are well-documented.

Developing Champions

You've set expectations for your Data Champions. How will you ensure they can meet those expectations? For example, a centralized team that is struggling to keep up with an influx of support requests may want to prioritize training their champions as Tableau experts who can help reduce dependency on their team. Similarly, if your champions are expected to be evangelists, you should plan champions-specific activities and communications that help them stay energized and informed of the latest in data and analytics efforts within your organization.

Most Data Champions programs will invest in champions-specific training and regular champions-specific community activities. Learn more about each in the following: [Data Champion Education and Training Resources](#) (PPTX) and [Data Champion Engagement Activities](#) (PDF)

These trainings and engagement activities will need to be planned in advance. You'll want to consider the cadence and other logistics when planning. For more information, see [Best Practices on Logistics and Staffing](#) (PDF).

Rewarding Champions

It is critical to build incentives into your program. Without the right rewards, your champions will have little motivation to meet expectations. Consider what champions will receive in return for their participation in the program, such as certifications and skill badges as described in [Accountability and Reward Systems on page 228](#) or special recognition that is communicated to leadership.

Running a Data Champions Program

You have the right foundations and have designed your program. Now, you'll need to consider how you'll brand and promote your program, identify your champions, and start running your program.

Branding your program

Choosing a brand means more than picking a fun name or designing swag. A brand helps you communicate the purpose of your Data Champions program to the rest of your organization, and ultimately helps your program be more cohesive and credible. You can get started using our [Data Champions Logo and Brand Guidelines](#) (PDF).

Identifying Champions

Finding users to participate in your Data Champions program can be challenging. And in some cases, you may not be able to identify champions that fit all your expectations. Remember that, above all, your Data Champions program is meant to invest in those who are passionate and enthusiastic about data and analytics. Here are a few different ways you can identify champions:

- Present the program at an existing engagement activity, such as a Tableau User Group or a Tableau Day. Use this [template](#) (PPTX) to get started.
- Look through your discussion forums and other chat-based communications (Slack, Yammer, etc.) and find the people who are most active in answering questions, providing insight, etc.
- Ask leaders to nominate champions.
- [Analyze your Tableau Server Repository data](#) to identify your most active users.
- Announce the program on your intranet, in your newsletter, or in your organization's other communication channels.
- Send a survey to all of your users.

Running Your Program

You've designed your program and identified the champions who will participate. Now, you'll need to plug your champions into the framework you've created, having them fulfill their duties while developing their skills and rewarding their participation. Here are additional best practices to consider when executing your program:

- Create a "Data Champions Directory" or another centralized resource that helps your organization connect to your champions.

- Keep track of your champion's activities, keeping them accountable to the expectations you originally set.
- Routinely survey your champions to better understand their experience and find ways to improve the program.
- Revisit your original business needs, goals, and metrics for success.

Peer-to-Peer Assistance

With peer-to-peer assistance, you encourage others to share and transfer their Tableau knowledge. This allows your user community to leverage the collective brainpower of the entire organization. A peer-to-peer assistance program will help develop talent and encourage sharing within your organization. By sharing knowledge and leveraging technical skills in a faster way, a peer-to-peer assistance program builds trust among peers, in the program used to enable them, and in Tableau products. Additionally, it provides a social learning experience with relevant topics and examples, and encourages collaboration, hive mind engagement, and internal problem solving. An organization that enables peer-to-peer assistance fosters continuous learning and shows a commitment to data culture, reduces the dependency on the core project team, and deflects the number of tickets opened with IT.

This section outlines mentoring, discussion forums and chat, and Tableau Data Doctor.

Mentoring

With mentoring, experienced Tableau users share their knowledge with others. Champions should take a lead role in onboarding within their teams or departments by mentoring new Tableau users, introducing available data sources, and providing informal check-ins to grow the analytical skills of their team members. Using data from [Measurement of Tableau User Engagement and Adoption on page 233](#), champions can partner with Server or Site Administrators to see which users are creating and consuming content and determine who might need more encouragement.

Tableau Discussion Forums & Chat

Discussion forums and other chat-based communications can provide users with information in real time. These methods can also become a knowledge base as archived chats can answer

questions that will arise in the future. Set up a Tableau discussion forum, chat room, and/or channel (Slack, Yammer, HipChat), and invite all your Tableau users to join.

Tableau Data Doctor

Tableau Data Doctor fosters engagement and enablement by connecting your Tableau experts with their colleagues who have questions or need help using Tableau. Data Doctors teach fellow employees how to use Tableau and provide one-on-one, and/or one-to-many support across the globe via chat channels, or live one-on-one sessions by listening to the “symptoms” and researching or testing for solutions. Whether they are in a dedicated role or volunteering their time, they are essential to Data Doctor programs of all sizes.

Before getting started

We recommend having the following foundations in place before getting started with your Data Doctor program enablement.

Sponsorship. Identify a sponsor who will be a strong advocate to support and promote Data Doctor in your organization and help you recruit volunteers. Having sponsorship support will help you gain budget approval if you want to invest in technology or secure incentives to reward your volunteers.

Work with your sponsor or your leadership team to confirm Data Doctor is the right solution for your organization to answer your employees’ Tableau technical questions. Ensure your enablement program is aligned with your organization’s business needs, goals, and metrics. For example, if your many individuals at your organization have access to Tableau but are not using it or users generally feel frustrated when they get stuck then your business case should address data-driven goals like:

- Use the Data Doctor program to increase internal engagement with the product by 10%.
- Leverage internal expertise to reduce IT tickets about Tableau products by 15%.

Invite your sponsor to be a part of your [Internal Tableau Activities on page 287](#) such as Tableau Days, Lunch and Learns, etc. so that they can reward, acknowledge, and appreciate the work and efforts made by all individual contributors.

Education. Your internal data community needs to gain Tableau skills and knowledge to reach their full potential and eliminate basic Tableau “how to” questions. For more information about how to train and upskill your organization, please see [Tableau Education on page 215](#) and [Developing a Tableau Education Plan on page 225](#).

If there is already an enablement plan in place in your organization, there may be a need to re-align all individuals who may be answering siloed questions. All Tableau product issues should be raised on a single platform (chat, office hours, or appointments), and siloed team members should be educated to redirect all individual questions to the correct platform/channel.

Centralizing Tableau questions in a single channel could also help reduce reliance on specific Data Doctors and allow more effective knowledge sharing. Wherever you are, be sure to evaluate the program at regular intervals to find opportunities to change, improve, or scale it.

Recruitment. At least one Tableau expert must be identified or hired to answer technical Tableau questions. Set the right expectation about the role, qualifications, the time commitment needed, and goals for their specific involvement.

For example, your Data Doctor might already have a Tableau Desktop Associate certification and volunteer two hours per week. To track their success, you would analyze month-over-month changes of license usage and the number of IT tickets created.

Data Doctor Benefits

There are many benefits of implementing a Data Doctor program in your organization.

Enable peer-to-peer issue resolution. Leverage the expertise of your Tableau champions and experts to help their peers via chat, office hours, appointments, or a practice/clinic.

Discover knowledge or skills gaps. Have your team, department, or organization take a Skills Assessment to evaluate and address the pain points, training, and knowledge gaps in your organization.

Grow data culture. Data Doctor underpins Data Culture, where users in your organization are able to support, govern, and see and understand their own data.

Reduce the number of IT tickets. Enable self-sufficiency and empower your Tableau users to help others instead of relying on your IT resources.

Data Doctor Toolkit Overview

The [Data Doctor toolkit](#) is a collection of resources to organize and host your own Data Doctor program. It includes detailed information on the following options:

Option	description	key features
Chat channel	Create a chat channel as the go-to place for your Tableau users to connect and ask questions. All chat channel members can help other members	<ul style="list-style-type: none"> • Low effort • Low maintenance

Option	description	key features
	whether they are an expert or just getting started.	<ul style="list-style-type: none"> • At least 1 Data Doctor needed
Office hours and appointments	Engage your internal Tableau community to drive higher Tableau product usage, reduce the number of IT tickets created, and connect in one-to-one interactions	<ul style="list-style-type: none"> • Moderate effort • Weekly maintenance • At least 2 Data Doctors needed
Run your own practice	Raise awareness, generate excitement, and connect with your Tableau user community multiple times a year.	<ul style="list-style-type: none"> • High effort • Dedicated time needed to plan and execute • At least 10 Data Doctors needed

External Tableau Community Forum

The Tableau Community forums are a source of information to answer Tableau-related questions. Chances are that if users have a question, someone else has asked it in the past, or will have the same issue in the future. This community of Tableau users learn, teach, and share ideas with each other so that the knowledge within it is continually growing.

To get started, review the [Tableau Forum Guidelines](#) and [Packaged workbooks: when, why, how](#). Visit this page to [create your Tableau account](#) and get started.