

HABILITATION THESIS

TEZA DE ABILITAE

**RESEARCH AND CONTRIBUTIONS IN THE
FIELD OF ENGINEERING AND MANAGEMENT**

DOMENIUL: INGINERIE ŞI MANAGEMENT

Autor:

prof. univ. dr. ing. BUNGĂU CONSTANTIN

Universitatea din Oradea

2014

Table of Contents

A.

SUMMARY	3
REZUMAT	5

B.

SCIENTIFIC AND PROFESSIONAL ACHIEVEMENTS

1. LEAN MANUFACTURING TECHNIQUES APPLIED IN THE OPERATIONAL MANAGEMENT OF PRODUCTION	7
1.1. Lean tools – Value stream mapping	11
1.2. Lean tools – 5S.....	15
1.3. Lean tools – kaizen.....	24
1.4. Lean tools – (kaizen) „A3 report”	29
1.5. The optimization of decisions.....	33
1.5.1 Optimization through linear programming.....	33
1.5.2 Optimizing decisions using the fuzzy logic.....	35
2. CONTRIBUTIONS TO INCREASE THE PRODUCTIVITY OF PROCESSES AND WORKING MACHINES	44
2.1. Contributions and research in MUCN retrofiting.....	44
2.2. The precision studies of the cnc machining centers.....	50
2.2.1. The precision analysis of the CNC machining center in static conditions	50
2.2.2. Precision evaluation of the CNC machining center in dinamic conditions	57
2.2.3. Thermographic diagnosis at machine tools.....	62
2.3. Research in the rotary-tilting table (RTT) field	68
2.3.1. The constructive design of the RTT	68
2.3.2. The ensure of precision work for RTT	75
3. RESEARCH APPLICATIONS IN UNIVERSITY EDUCATIONAL MANAGEMENT	85
3.1. Study on the mobility efficiency for doctoral student in research activity.....	85
3.2. Study on the promoting knowledge of sustainability in education curricula for technical MSc	90
C.	
THE EVOLUTION AND DEVELOPMENT PLANS OF THE PROFESSIONAL CAREER	98
References.....	Error! Bookmark not defined.

A.**SUMMARY**

The habilitation thesis carried out 12 years later after the PhD thesis presents, in a documented way, my professional achievements and my scientific contributions during this period of time.

A brief description of my achievements can be summarized in two areas: **academic/educational** and **scientific/research**. These are described in the **first section** (chapter B) of the habilitation thesis.

In the **academic/educational** area I supported as holder and coordinator the next disciplines/subject matters: Engineering of Production Systems, Machine Tools and Advanced Operations Management Techniques (course, laborator and project), for bachelor and master studies. I was coordinator for diploma projects (over 80 projects), dissertations (over 60) and also member in 14 doctoral committees for PhD thesis in Engineering and Management or Industrial Engineering fields.

I was coordinator in the implementation of the masters programs developed in the Bologna ECTS framework at the Faculty of Managerial and Technological Engineering from University of Oradea. I set up and I am coordinator of a postgraduate course in the field of Engineering and Management (The management and the risk assessment in the work security field and health). Also in the Engineering and Management field I have guided students to national professional competitions carried out under CIER (Consortium of Economic Engineering in Romania). At an international level I provide the management for the University of Oradea in a CEEPUS network in the industrial engineering field.

In the **scientific/research** area I obtained results based on scientific publications and implementation of grants/research projects on three directions with interdisciplinary topics, such as:

- a. Lean techniques applied in the operational management of the production;
- b. The integration of components within MUCN (CNC Machine Tools) and FMS (flexible manufacturing systems);
- c. Research with applications in university educational management.

The Lean technique used in operational management involves the use of specific tools for each application. Thus, after a perfect knowledge of the process in terms of technical and economical characteristics, there are established one or more "targets" that lead to the increase of economic efficiency. The indicators which define the economic efficiency are specific to each process or application, and in many cases are based on identifying and reducing losses (MUDA).

Thus, based on LEAN fundamental theory, I approached applied research that used different Lean tools: VSM, 5S, A3 Analysis, TPM, SMED, Kaizen, fructified through scientific publications in journals or sustained within the professional conferences.

The integration of the components and the growth of MUCN and FMS productivity, are concerns materialized in the retrofitting activity and development of rotary-tilting tables for machining in 5 CNC axis. To support this research I have received EU funding within the FP7 Programme, coordinating the research for the design, development and manufacture of rotary-tilting tables for machining on MUCN in 5 axis (MANUNET Project, RTT-5). The studies are focused on structure, kinematics and precision of these tables.

The performance in education and university management are newer concerns and are aiming analyzes, studies and approaches that implemented in the academic activity leading to superior quality indicators. Thereby I approached the quality management in higher education,

the development of skills in the field of sustainability for master studies, the development of ethics in research, the development of counselling activity, the promotion of internships.

I should mention that the approach of the three research directions above mention was based on the promotion and integration of the concept of sustainable development, actions also promoted through scientific publications in this field.

Besides scientific research in this area I have been involved in the POS-DRU projects that address the matter of efficiency in training students from a technical profile and also the support of scientific development at a doctoral and postdoctoral level (CV).

The acknowledgement and the impact of my scientific activity are embodied by the association with and the participation in the editorial staff or scientific committees of journals (4) and scientific manifestations (8) most important at national level (according to the A.3 sheet - habilitation conditions). The quality of founder member of AMIER (Romanian Managers and Economical Engineers Association) and holding the position of general secretary within the CIER (Consortium of Economic Engineering in Romania), (since 2008), gives me the opportunity of contributing to the consolidation of the Engineering and Management field.

Also the expertise gained in my teaching career allowed the cooptation and my involvement in national assessments of research projects (CNCSIS, ANCS, AMCSIT).

The direct involvement in university management activities (head of department, dean, rector) gives me the opportunity to promote the scientific activity in this area through studies and published research papers but also to support and coordinate at an institutional level of many educational and research projects.

All the research were carried in collaboration with researchers from the same fields or connected fields (project management, quality management, fuzzy logic, marketing, robotics, artificial intelligence, etc.), colleagues mentioned as coauthors in scientific papers specified in references.

In the **second section** (chapter C) of the habilitation thesis I present the evolution and research plan of my professional, scientific and academic career.

So regarding my professional career I intend to obtain the scientific coordinator of PhD thesis in and I will involve myself and participate in the accreditation and consolidation processes of the PhD field at the University of Oradea. I will also have in the forefront the national development of the Engineering and Management field by boosting and strengthening of the CIER (Consortium of Economic Engineering in Romania) and AMIER (Romanian Managers and Economical Engineers Association), as well as by involvement for the creation of a international network of this field.

The research directions developed until now, will be continued, deepened and exploited, and the new directions (Six Sigma, Intelligence Human-machine interface, Advanced Manufacturing and Processing) will be linked to current ones. Targeting the “smart research” is a priority generated also by the „Horizon 2020” program. It will be mandatory to direct the applied research towards socio-economic beneficiaries from the region and nationally.

The **third section** of habilitation thesis presents the references associated with the first two sections.

REZUMAT

Teza de abilitare realizată la 12 ani de la susținerea tezei de doctorat prezintă în mod documentat realizările mele profesionale și contribuțiile științifice de-a lungul acestei perioade de timp în domeniul inginerie și management.

O scurtă descriere a realizărilor se poate face sumativ atât pe linie **academică/învațământ** cât și pe linie **științifică/cercetare**. Acestea sunt descrise în **prima secțiune** (capitolul B) a tezei de abilitare.

Pe linie **academică/învațământ** am susținut în calitate de titular și coordonator disciplinele: “Ingineria Sistemelor de Producție”, „Mașini Unelte” și „Tehnici Avansate de Management Operațional” (curs, laborator și proiect), licența și master. Am fost coordonator de proiecte de diplomă (peste 80 proiecte), dizertații (peste 60) dar și membru în 14 comisii pentru susținerea tezelor de doctorat în domeniul Inginerie și Management sau Inginerie Industrială.

Am dezvoltat în calitate de coordonator masteratele desfășurate sub cadrul ECTS Bologna la Facultatea de Inginerie Managerială și Tehnologică de la Universitatea din Oradea. Am înființat și coordonez cursul postuniversitar în domeniul Inginerie și Management (Managementul și evaluarea riscurilor în domeniul securității muncii și sănătate). Tot în domeniul Inginerie și Management am îndrumat studenți la concursurile naționale profesionale desfășurate sub egida CIER (Consortiul de Inginerie Economică din România). La nivel internațional asigur managementul aferent Universității din Oradea pentru o rețea CEEPUS în domeniul ingineresc.

Pe linia **științifică/a cercetării** am obținut rezultate bazate pe publicații științifice și implementarea de granturi/proiecte de cercetare pe trei direcții cu tematici interdisciplinare, astfel:

- a. Tehnici Lean aplicate în managementul operațional al producției;
- b. Integrarea componentelor în cadrul MUCN (Mașini Unelte cu Comandă Numerică) și FMS (Sisteme Flexibile de Fabricație);
- c. Cercetări cu aplicații în managementul educațional universitar.

Tehnica Lean utilizată în managementul operațional implică utilizarea de instrumente specifice fiecărei aplicații. Astfel, după o cunoaștere perfectă a procesului din punct de vedere tehnic dar și economic, se stabilesc una sau mai multe “ținte” care duc la creșterea eficienței economice. Indicatorii care definesc eficiența economică sunt specifici fiecărui proces sau aplicații, în multe cazuri bazându-se pe identificarea și reducerea pierderilor (MUDA).

Astfel, bazându-mă pe teoria fundamentală LEAN, am abordat cercetări aplicative ce au utilizat diferite instrumente Lean: VSM, 5S, Analiza A3, TPM, SMED, Kaizen fructificate prin publicații științifice în reviste sau susținute în cadrul conferințelor de specialitate.

Integrarea componentelor și creșterea productivității MUCN și a FMS sunt preocupări concretizate în activitatea de retrofitting și dezvoltarea de mese roto-basculante (RTT) pentru fabricația/manufacturarea în 5 axe CNC. Pentru susținerea acestor cercetări am beneficiat de finanțare europeană în cadrul Programului FP7, coordonând cercetarea pentru concepția, dezvoltarea și fabricația meselor roto-basculante pentru mașinarea pe MUCN în 5 axe (Proiect MANUNET, RTT-5). Studiile sau focalizat pe structuri, cinematică și precizia acestor mese.

Performanța în educație și management universitar sunt preocupări mai noi și vizează analize, studii și abordări care implementate în activitatea universitară conduc la indicatori de calitate superiori. Am abordat astfel managementul calității în învățământul superior, dezvoltarea

competențelor în domeniul sustenabilității la studiile de master, dezvoltarea etici în cercetare, dezvoltarea activității de consiliere, promovarea intershipurilor.

Trebuie să menționez că abordarea celor 3 direcții de cercetare mai sus menționate a avut la bază și promovarea și integrarea conceptului de dezvoltare sustenabilă sau durabilă, acțiuni promovate și prin publicații științifice în acest domeniu.

Pe lângă cercetări științifice în acest domeniu m-am implicat și în cadrul proiectelor POS-DRU care abordează eficiența pregătirii studenților de la profilul tehnic dar și susținerea dezvoltării științifice la nivel de doctorat și postdoc.

Recunoașterea și impactul activității mele științifice sunt concretizate prin cooptarea și participarea în colectivele de redacție sau comitetele științifice al revistelor (în număr de 4) și manifestărilor științifice (în număr de 8) celor mai importante la nivel național (conform fișei A.3 - condiții de abilitare).

Calitatea de membru fondator al AMIER (Asociația Managerilor și Inginerilor Economiști din România) și deținerea funcției de secretar general în cadrul CIER (Consortiul de Inginerie Economică din România), din anul 2008, îmi conferă prilejul de a contribui la consolidarea domeniului Inginerie și Management.

Totodată expertiza dobândită în cariera didactică a permis cooptarea și implicarea mea în cadrul evaluărilor la nivel național a proiectelor de cercetare (CNCSIS, ANCS, AMCSIT).

Implicarea directă în activități de management universitar (șef catedră, decan, rector) îmi oferă posibilitatea să promovez activitate științifică și în acest domeniu prin studii și cercetări publicate dar și susținerea și coordonarea la nivel instituțional a multor proiecte educaționale și de cercetare.

Toate cercetările au fost realizate în colaborare cu cercetători din aceleași domenii de activitate sau din domenii conexe (managementul proiectelor, managementul calității, logica fuzzy, marketing, robotică, inteligența artificială etc), colegi menționați ca și coautori în lucrările științifice din cadrul bibliografiei dar și cu specialiști în cadrul firmelor de profil.

În a doua secțiune (capitolul C) a tezei de abilitare prezint planul de evoluție și cercetare a propriei cariere profesionale, științifice și academice.

Astfel pe plan profesional îmi propun conducerea de teze de doctorat în domeniul Inginerie și Management, implicarea și participarea la acreditarea și consolidarea acestui domeniu de doctorat la Universitatea din Oradea. Totodată voi avea în prim plan dezvoltarea la nivel național a domeniului Inginerie și Management prin dinamizarea și consolidarea CIER (Consortiul de Inginerie Economică din România) și a AMIER (Asociația Managerilor și Inginerilor Economiști din România) precum și implicarea pentru creerea unui network al acestui domeniu pe plan internațional.

Direcțiile de cercetare dezvoltate până acum vor fi continuate, aprofundate și valorificate, iar noile direcții (Six Sigma, Interfața Inteligentă Om-Mașina Unealta, Advanced Manufacturing and Processing) vor fi în conexiune cu cele actuale. Direcționarea către cercetarea inteligență este o prioritate generată și de programul “Orizont 2020”. Obligatoriu cercetarea aplicativă va fi direcționată către beneficiarii din mediul socio-economic din regiune și pe plan național.

În a treia secțiune a tezei de abilitare prezint referințele bibliografice asociate primelor două secțiuni.

B. SCIENTIFIC AND PROFESSIONAL ACHIEVEMENTS

1. LEAN MANUFACTURING TECHNIQUES APPLIED IN THE OPERATIONAL MANAGEMENT OF PRODUCTION

Increased competitiveness has also led to a significant increase in new production technology that has enabled a flexible production. Because of the flexible production has been converting traditional industry in an industry based on demand, reducing waste and energy consumption, which means reducing losses within the manufacturing process [16].

One of the most common operational management systems to help reduce these losses is Lean Manufacturing, which has developed within the Toyota Production System (Toyota Production System) [2], [57].

To transform a company based on a classical system in a Lean enterprise, must implement a set of advanced series operational management, and also necessary management commitment and involvement of all employees of the organization through the creation a structure to coordinate efforts for knowledge, analysis and synthesis of existing data to find and implement specific solutions to improve that actually means implementing a business system that organizes, manages and develops relationships with customers and suppliers [104], [88], [119].

The basic principles of Lean business system are focused on the following technical and economic aspects: customer satisfaction, continuous improvement (kaizen), eliminating waste (muda in Japanese) and achieve a continuous flow in production [3], [4], [81], [82].

The Lean focuses specifically on identifying and eliminating waste to increase profits, compared to the classic that focuses on identifying and increasing profit (those activities that create value), without taking into account the establishment of strategies to eliminate losses, dealing with the value-creating activities from within the operational flow [30].

Because of this classical system, often to increase profit increase stocks of raw materials, space, human resources and also the time, while Lean Management is to produce more with fewer or the same inputs, [105].

Using Lean techniques, is analyzed whole process step by step, identifying losses, then bring solutions to improve operations, increase efficiency and reduce costs [13], [42].

Losses are identified during a technological process (activities which create value) in general are found in 95%, only 5% being profit (value-creating activity - an activity for which the customer pays), which is based on operational flow analysis [16].

The operational management into the production is aimed the achieving of a high performance in terms of quality, time of realization product, is also a process of short-term targeting, interacting with the objectives and business strategies of long term, using human and material resources efficiently to achieve the goal [13].

Visual management plays an important role in this regard because it offers an overview of all components of the operating system, making it a real understanding of the activities within an enterprise, identifying value creating activities, also and losses [45].

One of the most popular advanced operational management is Lean Manufacturing, which is based on a combination of advanced techniques of operational management based [104], [88].

The fundamental principles underlying the whole lean philosophy is: customer satisfaction, eliminating waste (muda in Japanese), achieving a continuous flow in production and continuous improvement (kaizen) [64].

Due to fierce competition, many companies around the world have implemented Lean Manufacturing techniques, achieving a remarkable success proved by the results obtained [4], [57].

The main objective of Lean Manufacturing is to eliminating the waste (muda), which results in better use of working time, in other words, an increase of the total value-creating activities workflow [16], [84], [119].

Any activity that increases the value creating activities, improves working conditions, which is why Lean Manufacturing focuses on increasing labor productivity (value added activities), by identifying their losses in order to eliminate [16], [81], [105].

Losses occurring during a technological process (activities that do not create value) are found in 95%, only 5% is tax (value-creating activity - an activity for which the customer pays - Figure 1.1), [16], [63].

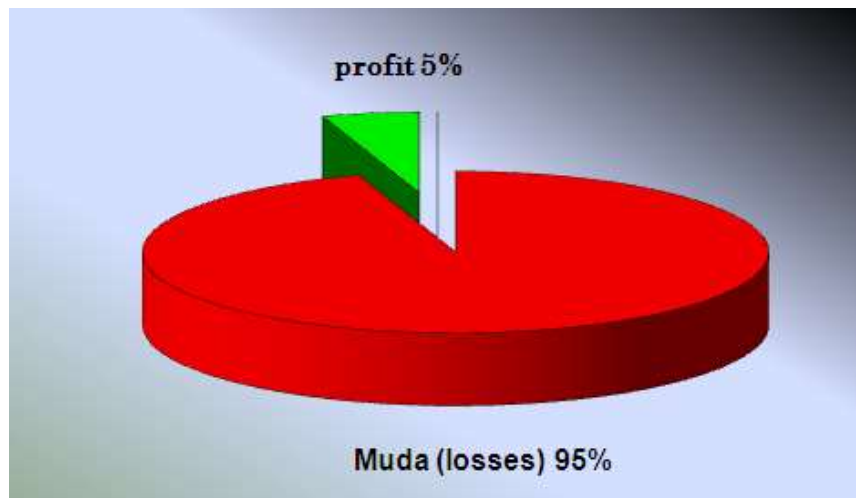

Figure 1.1 The percentage of the losses and profit [15]

These losses are found in seven forms in an operational flow, as motion, transport, over – production, waiting, defects, inventory and over – processing (figure 1.2) [16].



Figure 1.2 The seven losses (muda) identified in an operational flow [16]

The identification of these losses is performed using a visual management techniques, used in the Lean Manufacturing system, known as Value Stream Mapping [25], [100].

One of the most popular visual management techniques implemented in Lean Manufacturing is the 5S (6S) [5], [30], (Figure 1.3).

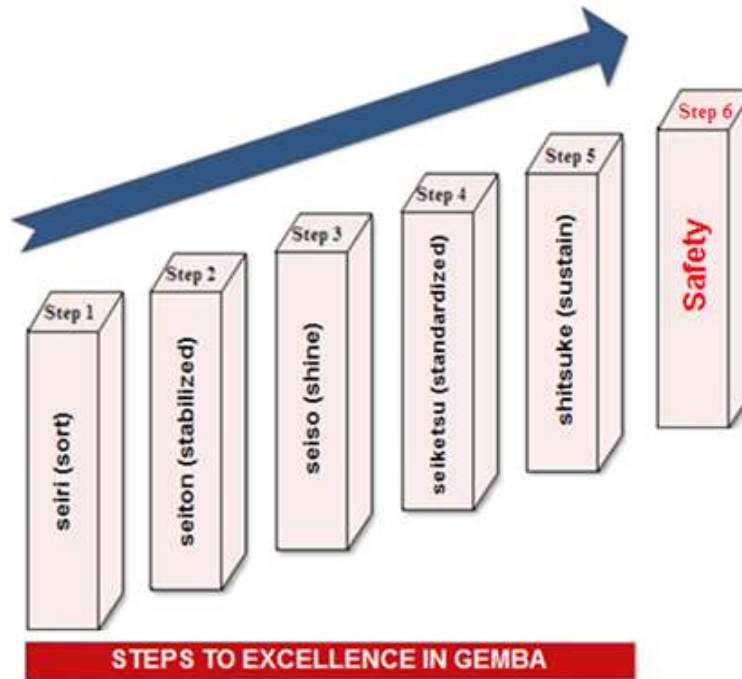

Figure 1.3 Steps of 5S implementation [16]

The 5S (6S) method is a structured program for implementation the standardization and organization in the workplace, simplifies the environment of the workplace (Gemba), reduce losses and unnecessarily activities , improves quality, efficiency and safety, being developed by Taiichi Ohno after second World War mondial [13], [14], [83].

The 6th "S" that is **safety** (6S) or secure workplace, depends on the following processes [16]:

- use of adequate tools / adequately marked;
- use of protective equipment where necessary;
- maintaining free access corridors;
- storage of protective equipment in predetermined locations and easily accessible.

A proper view which is obtained by proper cleaning and organization, is the starting point for solving problems at work that can not be clearly seen if there is a disruption or no cleaning [16].

5S (6S) is a method that can be implemented successfully both in the production (manufacturing) and office areas [16].

Keeping the workplace clean, providing a good working environment and promotes increased productivity, reduce costs, ensure security and removes all types of losses. Losses referred in this case are essentially economic loss (financial) and loss of time, once they are removed can be invested (managed) in research and development [16].

In conclusion, the 5S (6S) is to keep those things necessary for the proper conduct of the workplace and the elimination of useless things [16].

Implementation of 5S (6S) is closely linked to the principle of PDCA (Plan-Do-Check-Action - Figure 1.4). This principle was developed by William Edwards Deming. The first step is cleaning, which seeks to determine job status. This phase, specifically, can be exploited for planning activities, setting of objectives (Plan), together with the workers (employees). Actions are materialized (Do), after which the results are checked (Check). Finally, evaluate what has been found between the effort and objectives (Action), then redefine the new shares (Plan) and is assigned to individuals [16].

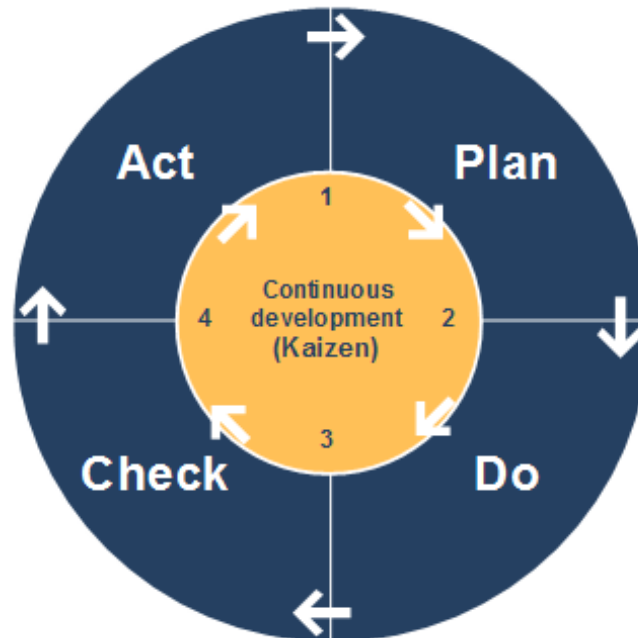

Figure 1.4 Deming Cycle Principle [16]

The key terminology used in Lean Manufacturing, which reduced losses by them implementing are: Kaizen, Kanban, Just in Time, gemba, ABC analysis, the 4M, the 5S, single minute exchange of die technique, Deming cycle (PDCA) product family, jidoka, Total Productive Maintenance -TPM, Poka Yoke, PUSH and PULL production system, etc [14].

Kaizen is a continuous improvement strategy which is given significance, so economically, but political and social also. This strategy envisages gradual improvement (with small steps) and continuous quality products and services and the productivity and competitiveness, involving all staff. In Japan is called kaizen. (Kai - change or improvement, zen - good, well [1].

Value stream mapping is one of the main tool used to identify the opportunities for various lean techniques. The most effective techniques used in Lean Management is Value Stream Mapping (VSM), which showed a remarkable efficiency to increase productivity [45].

Value stream mapping also is called the map of material and information flows, which proved to be an effective tool because of it example of flow through operational or manufacturing cycle, identifying both those losses and value creating activities [111]. Value stream mapping it was implemented in offices, in order to make new products or for submitting financial reports, sometimes to determine leadership, the behavior, beliefs or skills [63].

Value Stream Mapping (VSM) is an advanced technique operational management, which connects the information flow and material flow, aiming to identify existing losses in a business system based on Lean thinking [63].







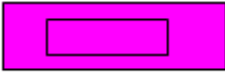

1.1. Lean tools – Value stream mapping [15]

We analyzed the manufacturing process of a tire manufacturing companies in Hungary, by exemplifying the stages Value Stream Mapping, which is an advanced operational management technique [15].

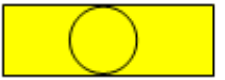
Based on video recordings we analyzed the technological process to identify losses, and then we use advanced techniques to eliminating them. Through this work i wanted to prove effective implementation of Value Stream Mapping in a manufacturing process, for which i have developed a detailed research work [15].

By carrying value stream map these losses are highlighted by using different colors specific of the technological process (table 1.1.1), [15].

Table 1.1.1 Value Stream Mapping symbols [15]

VSM symbols	Significance
	logistics
	control
	activity
	defect
	creative activity values
	stocks
	Proposal
	Limit of process
*	Estimated value
	Easy interventions
	Operating plan

The central aim is to analyze a process, to exemplify the value stream map (VSM), and to implement various techniques of operational Management for eliminating the losses incurred in process [15].

As with any lean management toolset the principle aim of Value Stream Mapping is to improve processes. This is achieved by highlighting areas of waste within a process and therefore enable businesses to eliminate these activities. Value Stream Mapping also has the benefit of categorising process activity into three main areas - value add, Non value add and waste [15].

The value stream includes the value-adding and non value-adding activities that are required to bring a product from raw material through delivery to the customer [15].

Methodology

For using this tool we have to implemented a set of rules [15]:

- map should include all actions (both value added, as well as non-value added) currently required to make the product to cover specific key processes.
- usually use a pencil and paper to draw a value stream map. But this is just the first step - next step concerns the current state analysis, the embedded solutions to improve the future state map, to prepare and implement an improvement action plan (with timelines, responsibilities, resources required and targets, established as clear).
- to implement only those steps which are considered important
- to establish the value stream map is designed so the flow of materials, as well as information flow, process of making specific product or service considered, from downstream to upstream process.
- being a cross-sectional approach is usually necessary to work in a multifunctional team to understand and figure the situation observed.
- the result sought is to determine the proportion of working time that adds value to the total time required for product or providing a service, from customer order receipt until delivery.

Knowing the real situation can begin analyzing the problems found, to find causes that give rise to losses that prevent a steady stream, found that the following questions [15]:

- 1) It complies with the flow during the cycle?
- 2) Workstations are balanced in terms of work load?
- 3) How to ensure a continuous flow of materials? What is the minimum possible batch?
- 4) How to simplify the flow of information?
- 5) How to reduce redundant information flow?

And proposed solutions to the causes of these problems fall into an action plan for improvement to enable the transition to a new situation, described by a future value stream map. Along with viewing the entire process can clearly see that there are losses during the unfolding of the entire process [15].

VSM may apply if you want to analyze a set of activities, from customer order to satisfying the client, but can also apply if you want to look at some stage part (phase) of a set of activities. In this case, i have examined a process, that road that you travel a worker to make a semi. This analysis was carried out in a tire manufacturing company in Hungary. Based on a video made inside the company, I watched every stage by the operator, starting from a blank registration barcode to obtain the finished product [15].

Value-stream maps can be drawn for different points in time as a way to raise consciousness of opportunities for improvement [57], [63], [15].

It is important to mention that this development of the value stream map (Value Stream Map), is analyzed in the perimeter of a single production cycle, from registration activities to obtain the finished product [15].

After implementation of VSM (present VSM) for technological process we obtained (figure 1.1.1), [15]:

- Percentage of losses (Muda): 92,42 %;
- Percentage of profits (value-creating activities): 7,57 %;
- Lost time: 67,08 minutes;

- Profitable time: 5,50 minutes.

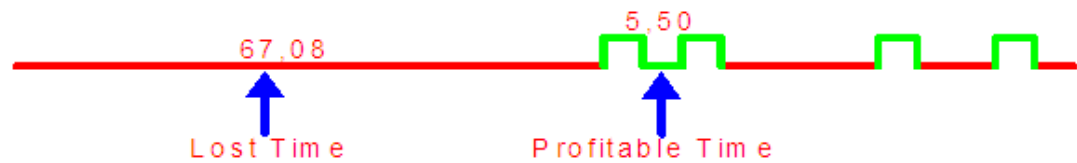

Figure 1.1.1 The lost and profitable time in the present Value Stream Mapping [15]

The lost time: 67,08 minute (for this the customer does not pay), [15];

The profitable time: 5,50 minute. (for this the customer pay), [15].

After identifying the losses that occur in this process, we created an ideal value stream map, which will eliminate light losses, implementing several techniques used in Lean Manufacturing (Total Productive Maintenance, Just in time, Kaizen, etc.), [15].

Losses we can eliminate in this process are [15]:

- 1 Stacker absence 13 min 20 sec;
- 2 No note the stacker 1min, 20sec;
- 3 Missing rubber band 34 min 51 sec;
- 4 Wrong Fixing Of Band 7sec;
- 5 Failure, Fell one sensor part, Maintenance delays 3 min and 30 sec 20m;
- 6 Other side fell sensor 1 min 20 sec;
- 7 Fall sensor 44 sec 20m.

After eliminating these losses we obtained (future VSM, figure 1.1.2), [15]:

- Percentage of losses (Muda): 68,35 %;
- Percentage of profits (value-creating activities): 31,65%;
- Lost time: 55,2 minutes;
- Profitable time: 5,50 minutes.

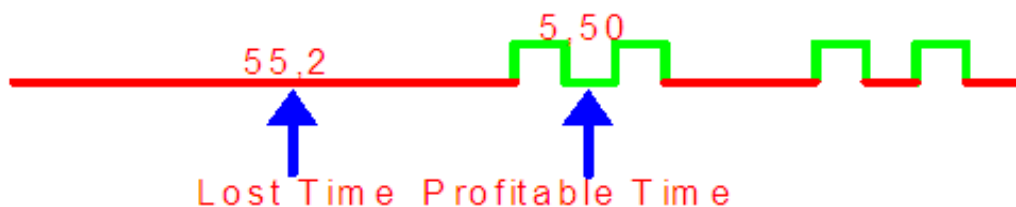

Figure 1.1.2. The lost and profitable time in the future Value Stream Mapping [15]

The lost time: 55,2 minute (for this the customer does not pay) [15];

The profitable time: 5,50 minute. (for this the customer pay) [15].

From the research i have done in this process, using Value Stream Mapping to exemplify the process i constat following conclusions [15]:

- The percentage and time of losses in present Value Stream Mapping is 92,42 %, this means 67,08 minutes.
- The percentage and time of losses in future Value Stream Mapping is 68,35 %, this means 55,2 minutes.
- The percentage and time of profits in present Value Stream Mapping is 7,57 %, this means 5,50 minutes.

- The percentage and time of profits in future Value Stream Mapping is 31,65%, this means 5,50 minutes.
- The data mentioned above we see that I have gained with 24.08% profit after implementing VSM and Lean techniques.

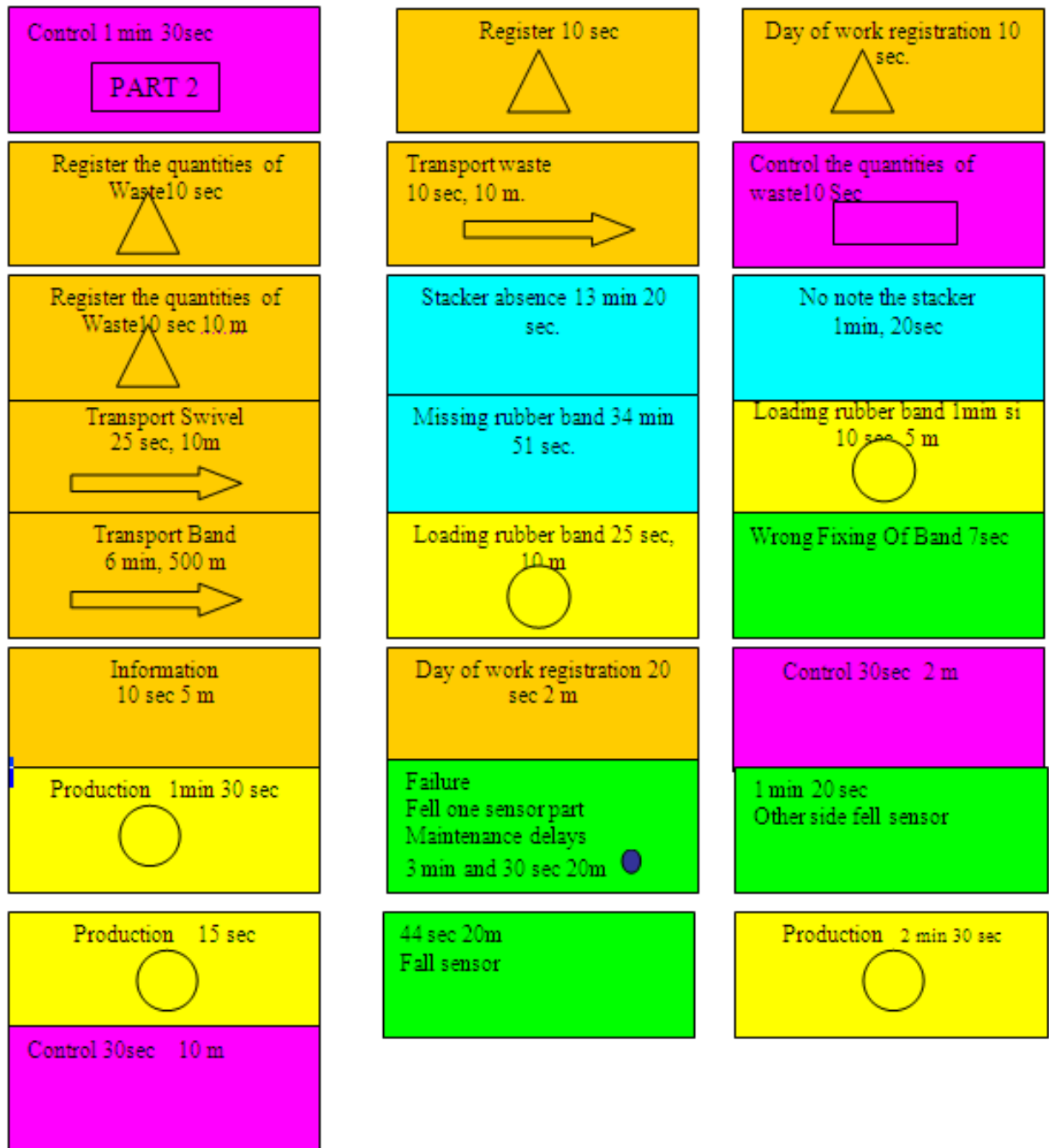

Figure 1.1.3. Unfolding Value Stream Mapping [15]

1.2. Lean tools – 5S [16], [17]

The 5S is an advanced operational management technique, which is achieved by implementing simplified the environment of workplace, reduce waste and pointless activities (ineffective), the chroming of quality, efficiency and safety work. The 5S technique consists in selecting, arranging, cleansing, standardizing and sustaining of the workplace, so that specific activities to manufacture a product to achieve in optimal conditions [16].

The purpose of the implementation of 5S is to identify and remove dirt and disorder in the area of employment [16].

Implementation of this principle must take into account the respect of advice and logical sequences. Implementation of 5S should be done in the following order: Seiri, Seiton, Seiso, Seiketsu, Shitsuke [16].

The next application [174] made in a company which producing carcass type parts for electronic components, using a computerized microprogram for implementation of 5S.

In this case the 5S is implemented to achieve the following results [16]:

- Improve efficiency;
- Basis for improvement;
- Support the positive motivation of the operators;
- The build company image;
- Fewer quality problems.

5S Implementation involves the driving of the following steps:

1. Preparation [16]

- The company culture;
- Core team;
- The purpose and seriousness of the project;
- Pilot project;
- The implementation plan & resources;
- Intern communication of the project.

2. Initial Audit [16]

- Witness the current situation;
- Multidisciplinary Team.

3. Education [16]

- All persons involved;
- Use the best of company;
- Proposals received improvements;
- Solving problems before starting;
- Presentation of implementation plan.

4. The five steps of 5S principle [16]

Figure 5 shows the 5S Audit interface, using a computerized management system in Excel, which has driven the steps in the implementation of 5S, also explains each step of implementation, results and targets achieved [16].

Steps to achieve better results [16]:

Sorting

Remove everything pointless / which is not needed.

Defines the method (apply red tag).

Result: the search falls, increase safety, increase efficiency.

Examples of production: cabinets, components, documentation, test systems, packaging materials, shelving, work tables, scrap.

Set in order

Definition of fixed locations for materials, components, documentation, test systems, packaging materials, personal property.

Use shelves, areas dedicated / marked, cabinets, garbage cans.

Put everything in order:

- finding / placement of things easier;
- By frequency of use.

Use the markings on the floor to define the crossing walk.

The presentation explained.

The result is to create a visual flow that abnormal situations are detected by everyone.

Shine

Initial cleaning.

Now dirty points are visible to cleaning .

Provides enough material for cleaning.

Cleaning purpose: it tends on (floor, benches, cabinets, test systems, shelving) to prevent dust and stains should be removed.

Standardized

Tracking department work standardizing the method (mode test systems, organizing scrap).

Using a standard equipment on all bench (tools, boxes, etc.).

Creating a standard procedure.

Implementation of the standard procedure.

Sustain

Maintain all improvements implemented.

Implemented kaizen.

Involve all employees in the department.

Results should be visible to the audit results and actions.

Periodic review of implementation:

- Heads of Department: daily;
- Q.A.: Monthly.

The action plan resulting after audit contain the necessary actions as a result of nonconformities found during the audit, the responsible of action and the deadline for taking action [16].

Using computerized management system, using the computerized microprogram for implementing 5S, 5S audit was presented with the work associated with each "S" (step) basis [16].

It analyzes each "S", based on specific questions, highlighting the real state of the workplace (Gemba), offering to improve an overview of those elements that have achieved a low result [16].

According to the responses for each "S", is obtained a score, which eventually is gathered from each "S", achieving a final score, which has reached or not the proposed target [16].

After analyzing the initial state of Audit is carried out a new action plan aimed at improving those "S" who obtained low results [16].

Quantification of 5S is achieved by means of questions (number 10) specific of each 'S', as presented in the tables below [16].

1. It highlights the quantification of "S1", answering the following questions (Table 1.2.1) [16], [17]:

Table 1.2.1. Questions and comments to quantification of the "S1" [16], [17]

"S1" (Seiri = sort)	"Separation the necessary things of the useless/unused things"		Remarks, comments
	The followed action	yes	
1. Are separate in department the useless things, that can disturb the workplace?			x
2. Instructions, drawings, old procedures are removed from work areas?			x
3. There are tools, materials, components / spare parts removed from the floor, near the equipments?			x
4. Are all the items / tools used frequently sorted, arranged, stored and / or labeled?			x
5. Are all instruments / devices for measuring sorted, arranged, stored and / or labeled?	x		
6. There is one person responsible for sorting things useless / non-use?			x
7. Are removed machinery / equipment wich are not longer used?			x
8. Are removed from around tools, parts or other objects that are not longer used?	x		
9. All items considered useless were sorted?			x
10. Implementation of 5S led to the discovery and removal of outdated standards?	x		
Final score		3	7

Total score achieved by ticking "yes" to questions can be maximum 10 [16], [17].

On the right side of the table, for "S1" audit team can make the following remarks or observations, depending on each case, such as [16], [17]:

- empty boxes stored above table and under worktable;
- documentation is scattered in the work zone / are not properly sorted and distributed;
- boxes on the lane access;
- mixed components at worktable;
- lack of clamps for documentation attaching;
- mixed projects / unidentified at worktable (listed individually);
- incomplete documentation.

2. It highlights the quantification of "S2", answering the following questions (Table 1.2.2) [16], [17]:

Table 1.2.2 Questions and comments to quantification of the „S2” [16], [17]

"S2" (Seiton = Set in order)	"Creating and maintaining conditions that ensure easy access to the necessary"		Remarks, comments
	The followed action	yes	
1. Accessories and tools are arranged rationally, so that they can easily be taken and put in place, depending on how much is used?			
2. Are production units, workshops, equipment, production lines and processes clearly identified?		x	

3. There are tools, devices, the sorted tools , organized, arranged by category?		x
4. Are the containers, containers with different solutions and pallets stored under appropriate conditions?	x	
5. Access to fire extinguisher is easy?		x
6. Is the floor without cracks, breaks, scratches?		x
7. Are marked all areas, shelves and storage locations?		x
8. Are marked the all boxes with forms to indicate the made of last phase?		x
9. Are shelves used properly, according to their identification?		x
10. The access routes are clearly identified and free? Outputs are clearly labeled and free?		x
Final scor	2	8

On the right side of the table, for "S2" audit team can make the following remarks or observations, depending on each case, such as [16], [17]:

- unidentified components at worktable;
- blocked access aisle;
- boxes used another purpose at workplace;
- unidentified projects at workplace;
- unidentified plates at workplace;
- project on the lane;
- workbenches blocked.

3. It highlights the quantification of "S3", answering the following questions (Table 1.2.3) [16], [17]:

Table 1.2.3. Questions and comments to quantification of the „S3” [16], [17]

"S3" (seiso = shine) "By cleaning can identify and solve some problems. Clean dirt and dust to keep away."			
The followed action	yes	no	Remarks, comments
1. Are all cleaning equipment is stored in an appropriate place?	x		
2. Are the equipment / machines clean? Are removed traces of oil, dust, debris materials, waste?	x		
3. It is obvious the place where are stored the cleaning equipment?		x	
4. The drainage systems for oil and waste of cars are dirt (partial or total)?		x	
5. The lighting sistem are working properly? Lamps, lighting and windows are clean?	x		
6. The floor area is clean, shiny, free of oil or other solutions?	x		
7. Machinery and equipment are cleaned periodically to keep clean, free of oil and scrap?		x	
8. Inspection equipment is combined with the maintenance of them?	x		
9. There is one person responsible for verification of cleaning?	x		
10. Operators used to clean the floor and machinery / equipment without being told?	x		
Final Scor	7	3	

4. It highlights the quantification of "S4", answering the following questions (Table 1.2.4) [16], [17]:

Table 1.2.4. Questions and comments to quantification of the „S4” [16], [17]

(S4 = Seiketsu = Standardized)		"Standardization leads to the observation of anomalies by a simple visual inspection."		
The followed action	yes	no	Remarks, comments	
1. People have adequate clothing and clean?	x			
2. The work environment provides adequate light and ventilation?	x			
3. Work areas are protected from noise, vibration, heat / cold?	x			
4. Is ensured a proper ventilation?	x			
5. There are designated areas for lunch break and smoking?	x			
6. There are first aid kits easily accessible and completed with the periodic requirements?	x			
7. Fire hoses, fire extinguishers and other emergency equipment are marked and have free access?	x			
8. Procedures / work instructions are well / clearly formulated and enforced?	x			
9. Audit action plans are clearly defines, delegating responsibility for achieving the objectives?	x			
10. Are the first three steps of the 5S system implemented and respected in time?		x		
Final Scor	9	1		

On the right side of the table, for "S4" audit team can make the following remarks or observations, depending on each case, such as [16], [17]:

Ex:

- Project with missing improperly identified;
- Previous audit actions are open.

5. It highlights the quantification of "S4", answering the following questions (Table 1.2.5) [16], [17]:

Table 1.2.5 Questions and comments to quantification of the „S5” [16], [17]

(S5 = Shitsuke = Sustain)		"Usual for rules respect"		
The followed action	yes	no	Remarks, comments	
1. Is performed a daily checks of the cleaning?	x			
2. Daily reports are completed correctly and timely?	x			
3. Wear suitable protective clothing?	x			
4. There are special equipment (ex. goggles, gloves) when needed?	x			
5. There is a regular 5S audits to check the all departments compliance?	x			
6. Are the all employees adequately trained in the procedures work?	x			
7. The telephone number is displayed in an emergency and easy to identified if necessary?		x		
8. Are visible the STOP buttons in case of danger and arranged for easy access?	x			

9. The procedures are updated and checked regularly?	x
10. Are the activity tables updated and checked regularly?	x
Final Score	9 1

The result of research

With the computerized management system, using the computerized micriprogram to implement the 5S, it was presented the 5S audit with the associated activity for each "S" (step) [16], [17].

According to the obtained positive responses to each "S", has abstained final score wich is centralized in a spider diagram, representing the initial audit state. The proposed target for each "S" is 9, so each "S" must obtain a minimum score of 9 and a total score of 45, for all 5S. In case of the questions which received a negative response, has take action to obtain an affirmative answer, which increases the target, the "S" that was proposed for improvements [16], [17].

According to the first table in figure 1.2.1, can identify the baseline audit (a total score of 30), for each "S" in part, as follows [16], [17]:

- For "S1" the score is 3 (table 2.1);
- For "S2" the score is 2 (table 2.2);
- For "S3" the score is 7 (table 2.3);
- For "S4" the score is 9 (table 2.4);
- For "S5" the score is 9 (table 2.5).

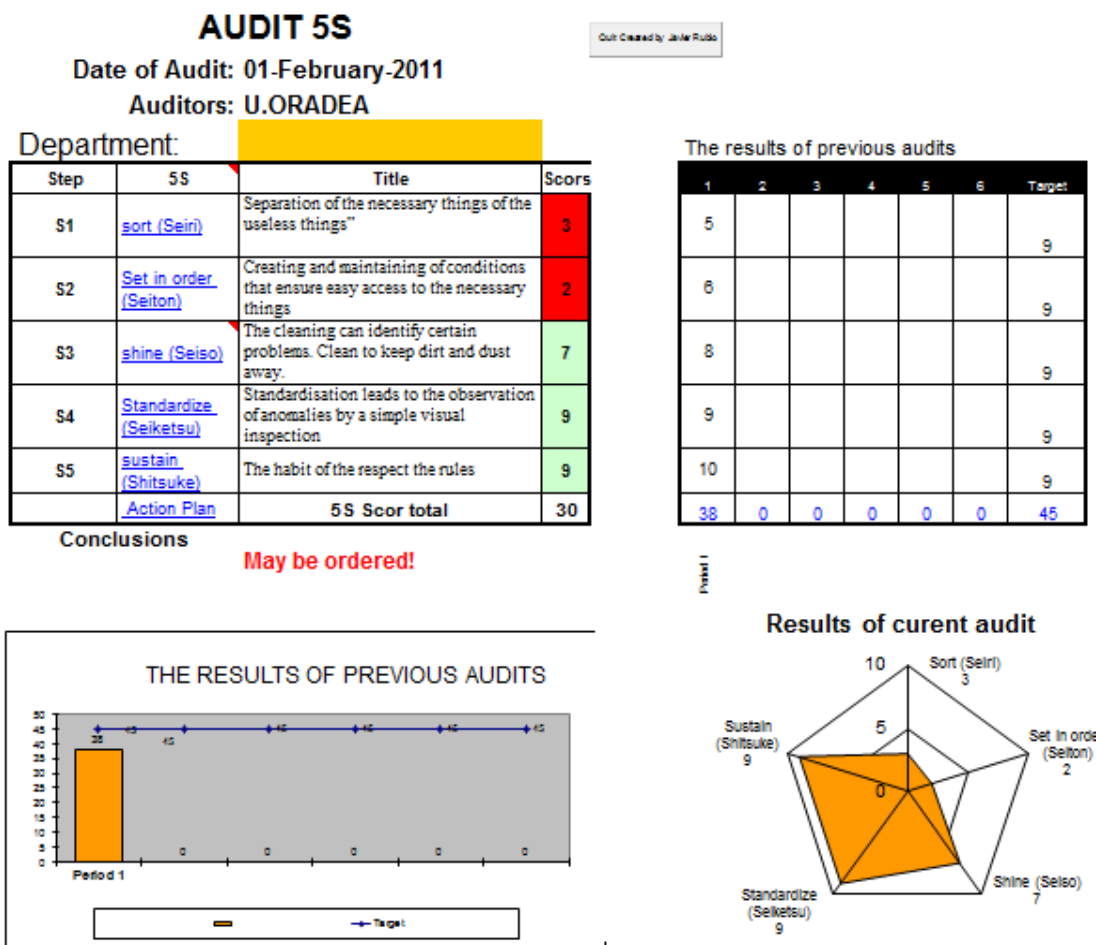

Figure 1.2.1. Initial state after first implementation of Audit [16], [17]

After first implementation of the 5S achieved a total score of 38 (Figure 1.2.2 - the results of previous auditors) [16], [17].

Proposed target was 45 (a target of 9 for each "S"), the diagram of the results of previous audits, so these targets were not achieved only by "S4", which remained the same (the original) and "S5" which increased from 9 to 10 (exceeded a proposed target with one) [16], [17].

Also have been improved the first three "S", but has not reached the proposed target for each "S", achieving the following scores [16], [17]:

- For "S1" the score is 5 (the initial audit <5 <target proposed);
- For "S2" the score is 6 (the initial audit <6 <target proposed);
- For "S3" the score is 8 (the initial audit <8 <target proposed).

Following this improvement "S4" remained constant, but the proposed target was surpassed "S5", with 1 [16], [17].

According to the spider diagram (Figure 1.2.2) can be identified increasing of each "S" obtained from improved, compared with the spider diagram from figure 1.2.1, [16], [17].

Results from the first implementation of the 5S

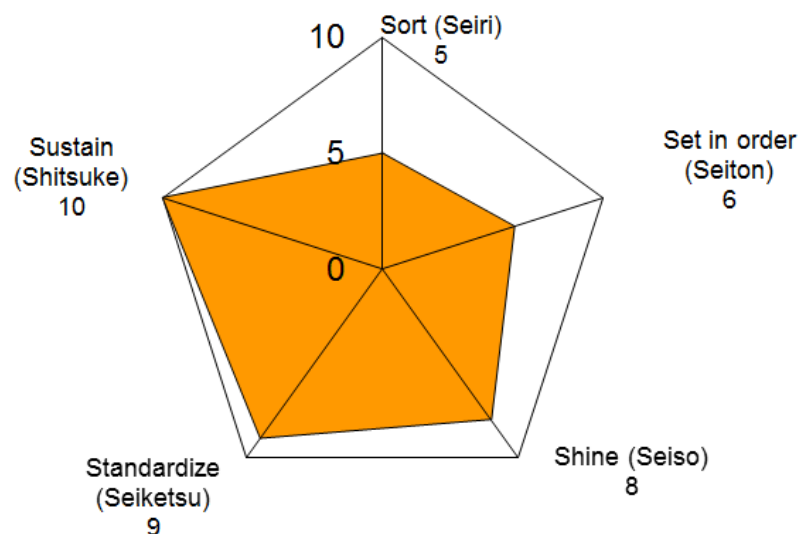

Figure 1.2.2. Spider diagram after first implementation of the 5S [16], [17]

So in the following period, in order to achieve the proposed targets will improve the next "S" [16], [17]:

- "S1" (sorting);
- "S2" (set in order);
- "S3" (shine).

According to research first period of implementation of the 5S, has developed a new action plan, which was proposed to improve those "S" (the first three "S") who have not reached the intended target [16], [17].

Following improvements implemented have achieved the following results (Figure 1.2.3 - period 2 for implementing the 5S) [16], [17]:

- For "S1" the score is 8 (Period 1 <8 <target proposed);
- For "S2" the score is 7 (Period 1 <7 <target proposed);
- For "S3" the score is 9 (Period 1 <9 = target proposed);
- For "S4" the score is 9 (Period 1 <9 = target proposed);
- For "S5" the score is 10 (Period 1 <10> proposed target).

According to the spider diagram (Figure 1.2.4) may identify increased the each "S" obtained from improved compared with the spider diagram in figure 1.2.2 (first period of implementation) [16], [17].



Figura 1.2.3. Initial state of audit after the second and third periods of implementation [16], [17]

So during the second period, in order to achieve the proposed targets after the first period, has improved the following "S" [16], [17]:

- "S1" (sorting);
- "S2" (set in order);
- "S3" (shine).

"S4" and "S5" remained constant over the first period of implementation [16], [17].

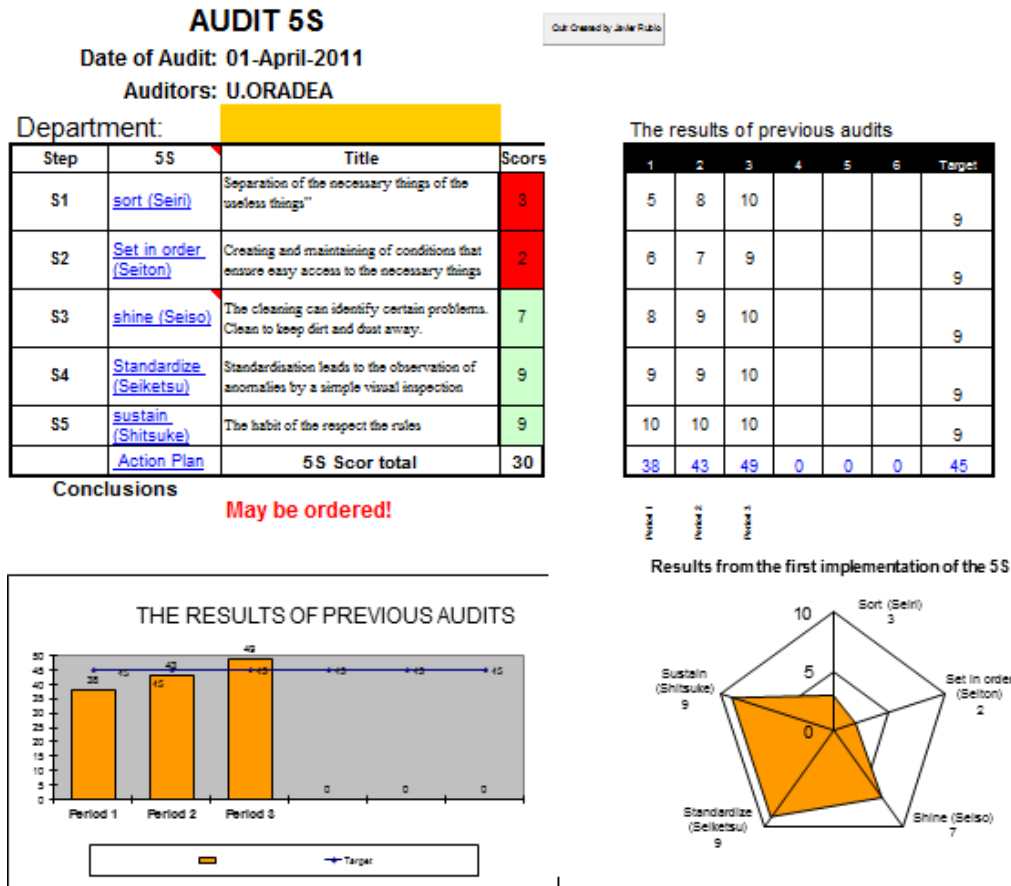
Total score obtained during the implementation of the 5S is 43 > first period, but less than the total proposed target [16], [17].

According to the research of the second period for implementing the 5S saw a new action plan, which was proposed to improve those "S" (first two "S") who have not reached the intended target [16], [17].

Following improvements implemented have achieved the following results (Figure 1.2.3 - period 3 for implementing the 5S) [16], [17]:

- For "S1" the score is 10 (Period 2 <10> target proposed);
- For "S2" the score is 9 (Period 2 <9 = target proposed);
- For "S3" the score is 10 (Period 2 <10> target proposed);
- For "S4" the score is 10 (Period 2 <10> target proposed);
- For "S5" the score is 10 (Period 2 <10> proposed target).

According to the spider diagram (Figure 1.2.5) may identify increased the each "S" obtained from improved compared with the spider diagram in Figure 1.2.4 (second period of implementation) [16], [17].

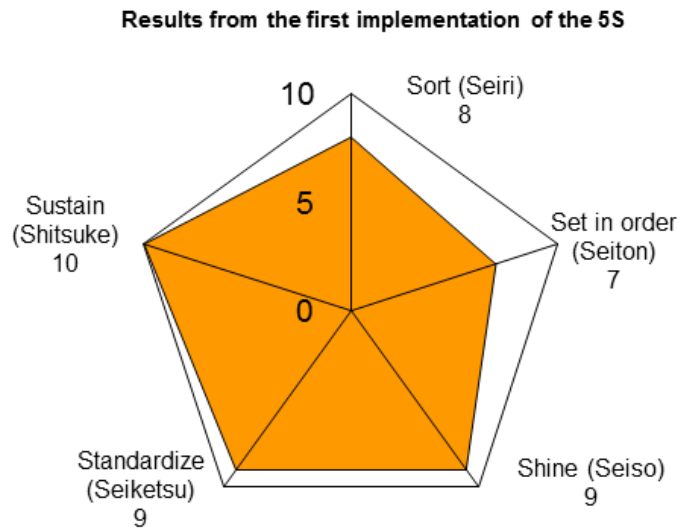

Figure 1.2.4 Spider diagram after second implementation of 5S [16], [17]



Figura 1.2.5. Spider diagram after third period of the 5S implementation [16], [17]

So in order to achieve the proposed targets after the second period of implementation of the 5S, in 3-rd period it was improved the next "S" [16], [17]:

- "S1" (sorting);
- "S2" (set in order);
- "S3" (shine) ;
- "S4" (standardized);
- "S5" (sustain).

"S2" has reached the intended target, and "S1", "S3", "S4" and "S5" exceeded the proposed target ("S5" exceeded the proposed target ever since the first implementation of the 5S) [16], [17].

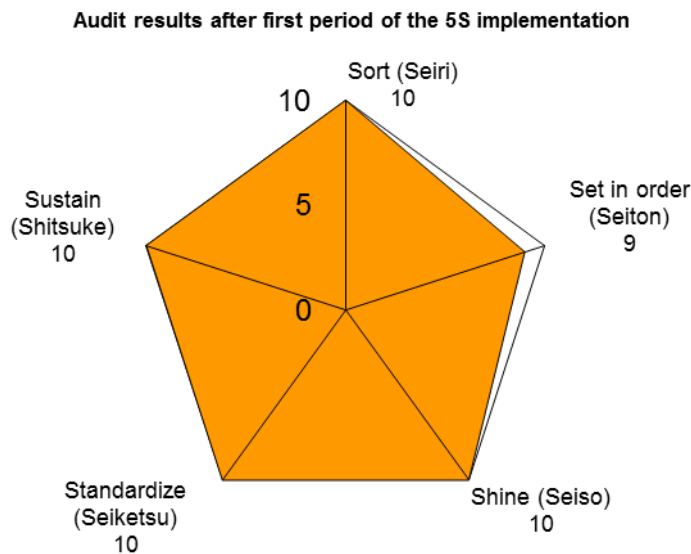
5S audit is conducted every two calendar months scheduled, also whenever required by auditors appointed unscheduled (quality engineers) in the quality department [16], [17].

1.3. Lean tools – kaizen [18]

The basic principles of Lean business system are focused on the following technical and economic aspects: customer satisfaction, continuous improvement (kaizen), eliminating waste (muda in Japanese) and achieve a continuous flow in production [18].

Kaizen focuses specifically on identifying and eliminating waste to increase profits, compared to the classic that focuses on identifying and increasing profit (those activities that create value), without taking into account the establishment of strategies to eliminate losses, dealing with the value-creating activities from within the operational flow [18]. [83].

To implement the kaizen technique in a cutting operation process, has been used one of the most important lean tools, under the name of Value Stream Mapping (VSM) [63].

Continuous improvement for the workplace "guillotine" [18]

Putting it into practice Lean techniques will improve a work area called Guillotine G1 (figure 4.1), within the manufacturing cycle [18].

The G1 Guillotine (Figure 1.3.1) is used to cut rubber bales from 500 to 850 mm wide and 150-700 mm high. Thickness of cut manually adjustable între 100 mm and 350 mm [18].



Figure 1.3.1. The G1 Guillotine [18]

For this action has made a statement showing [18]:

- objectives;
- contribute to the improvement team;
- indicators;
- improve the starting date;
- initial state;
- resources necessary for the action.

Manufacturing cycle analysis [18]

The manufacturing cycle analysis were obtained according to operational time of each operation separately. Using Value stream mapping was graphically exemplified operational timing sequence of this manufacturing cycle [18].

In order to simplify the flow of the value stream mapping, have gathered all of the operational timing operation, because the production cycle is repeated a wide selection of similar surgery. The purpose of value stream mapping illustrate in this case is to emphasize the production cycle as a whole, which identified opportunities for improvement by reducing the operational timing of certain operations [18].

The total operational time are presents in table 1.3.1 [18].

Table 1.3.1. Totality of operational time [18]

No.	Name of operation	Time/operation [min]	Period
1	Arranged on foil G1 pieces	16	Primary
2	G1 loading	69	
3	G1 evacuation	180	
4	Cushion adjustment	16	
5	Move the label	2	
6	Worked in manual at guillotine	16	
7	Led the cushion unprocessed from supply to evacuation	6	
8	Prepared station	7	Secondary
9	Arrange empty pallet	3	
10	Supplied with foil and foil cut in pieces	22	
11	Cleaning	12	
12	Waiting cycle	39	Waiting
13	Professional discussion	1	
14	Waiting for supply Stacker	22	
15	Waiting stacker for evacuation	2	Auxiliary
16	Irregularity to G1 evacuation	1	
17	Micro fault at the sensor	10	Break
18	Drinking water	2	
19	The biological needs	5	
20	Break for lunch	46	
21	Break for 5 minutes	8	
	Total	485	

As presented in table as identified operations, they are structured in five categories, namely periods (primary, secondary, waiting, auxiliary and break), the first seven operations, which are included in the main category, which are operations that added the value of product. In the below diagram can identify the operational time of each operation, expressed in minutes (Figure 1.3.2), [18].

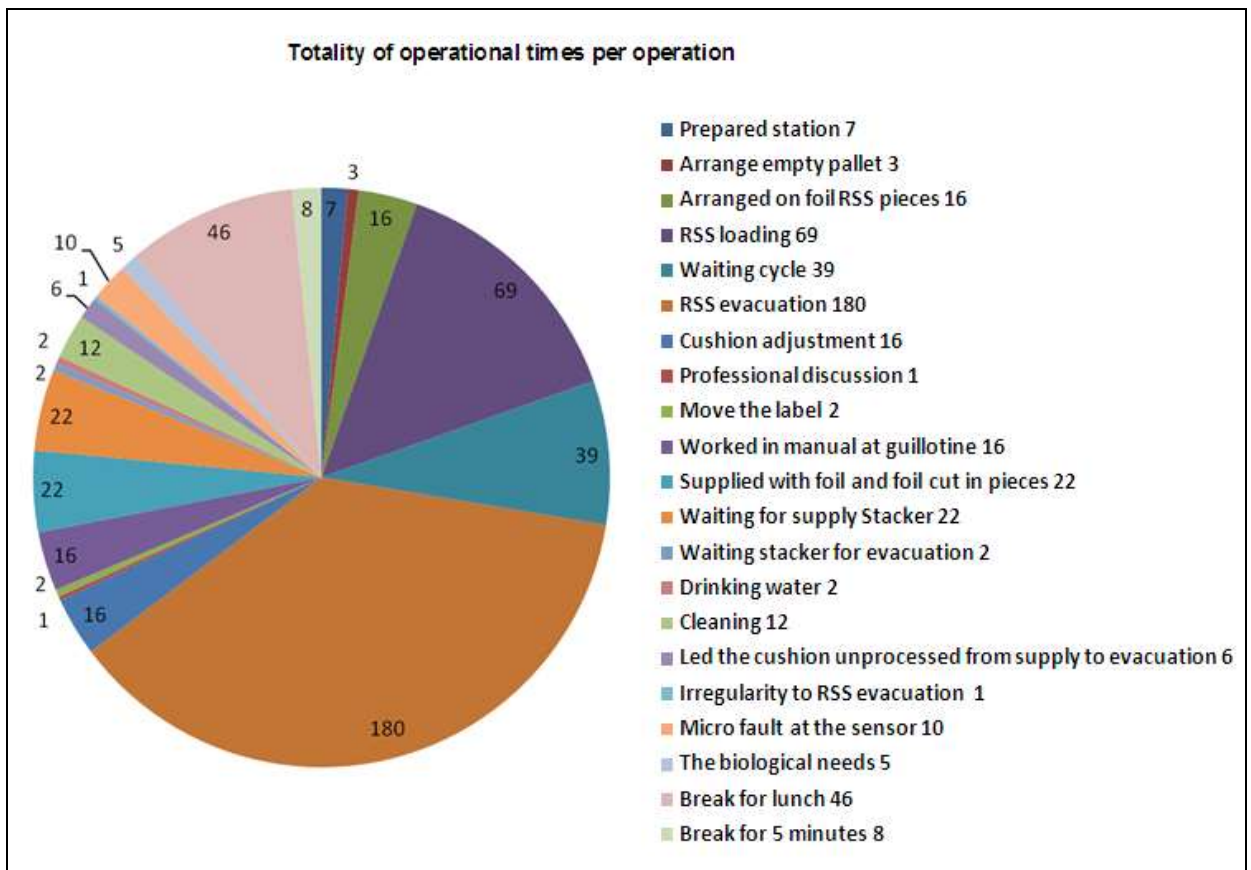

Figure 1.3.2. Diagram of operational times [18]

According to the 21 operations listed in Table 1.3.1, the the value stream map was built using the colors of each period, the respective operations. Total time of this cycle of production is of 485 minutes, from which time profitably (value creating activities) is 305 minutes, which reprizinta 63% of full cycle, and 37% non-values representing activities (according to data presented in chart the percentage of structured operations five times before implementing VSM, figure 1.3.3), which are actually loss (*muda* in Japanese). Through continuous improvement (*kaizen* in Japanese) will search for solutions to eliminate those losses [18].

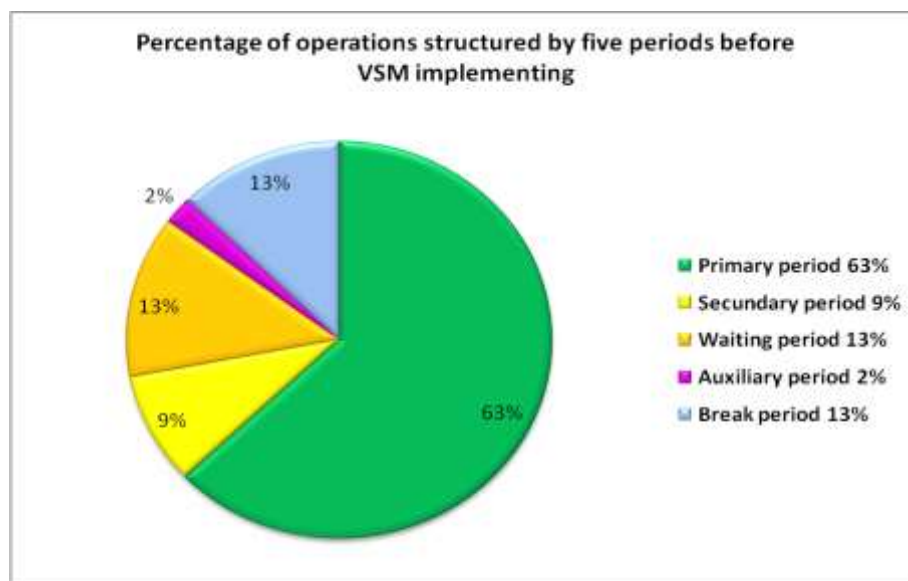

Figure 1.3.3. Diagram of operations structured on five periods before implementing VSM [18]

The graphical view the whole production cycle, implementing the value stream mapping (Figure 1.3.4), were also identified activities and non-values and possible improvements, which is done focused on eliminating waste (muda), by various advanced techniques operational management [18].

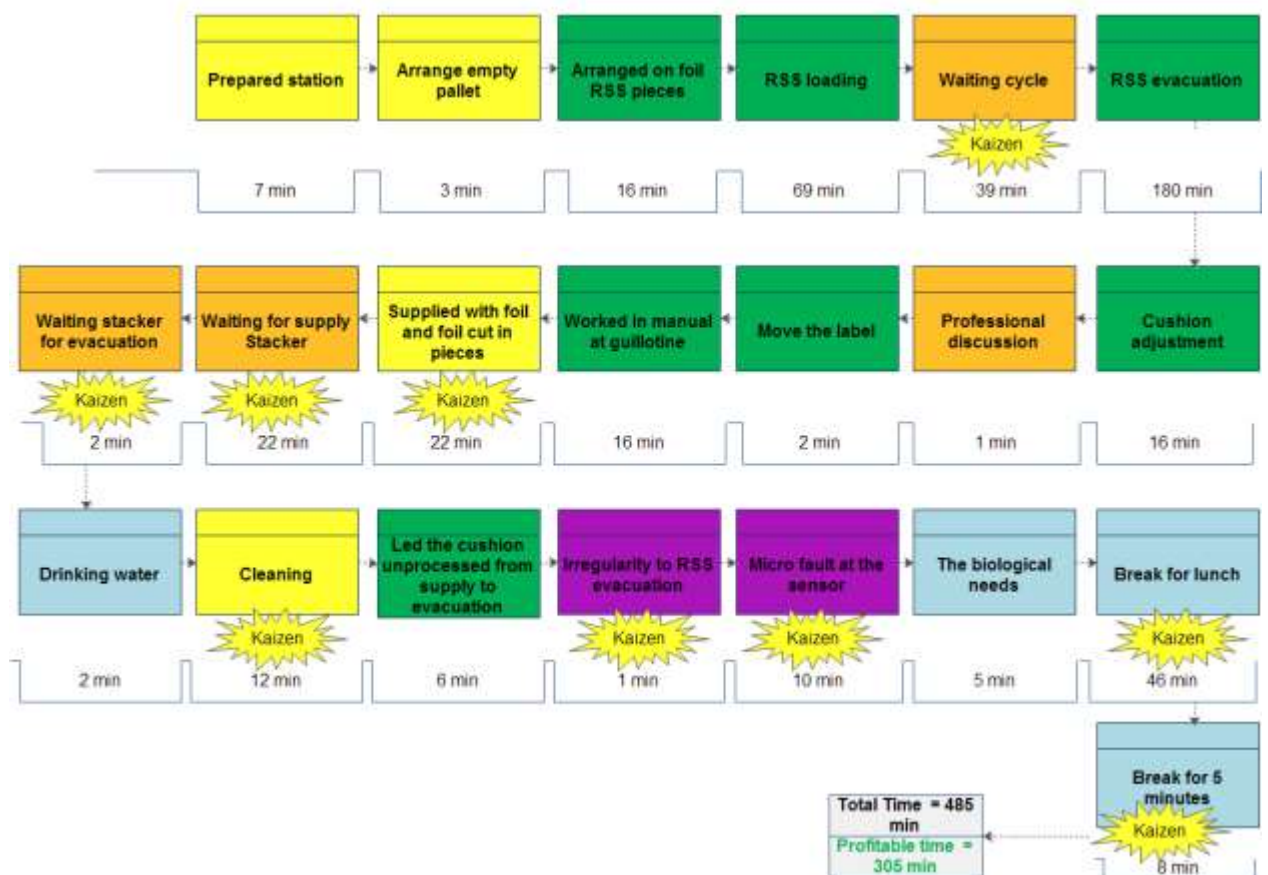

Figure 1.3.4 The present value stream mapping [18]

To increase the profit, Manufacturing Lean techniques focus on eliminating of as many losses in other words the dead time of the production cycle [18].

After analyzing the production cycle and especially the losses and made some improvements, reducing the operational time to the following operations [18]:

- Waiting production cycle;
- Waiting stacker for evacuation;
- Waiting for supply Stacker;
- Supplied with foil and foil cut in pieces;
- Cleaning;
- Irregularity to G1 evacuation;
- Micro fault at the sensor;
- Break for lunch;
- Break for 5 minutes.

In figure 1.3.5 we can see a growing percentage of the main period, due to the operational times of certain operations and even the complete elimination of auxiliary period by remedying the technical faults [18].

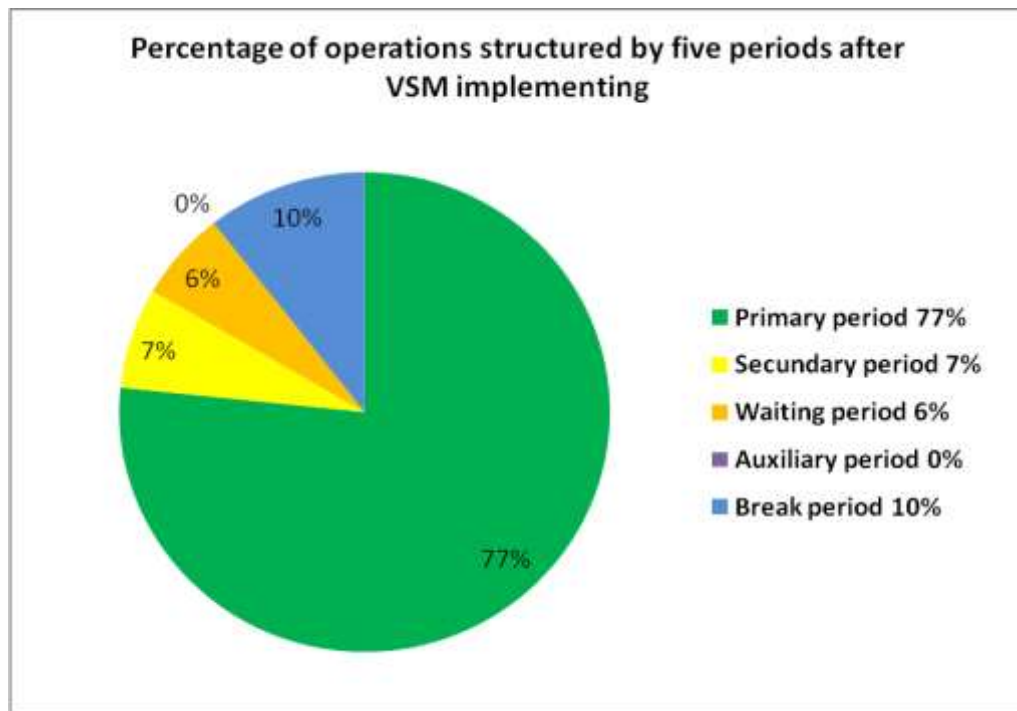

Figure 1.3.5. Diagram of operations structured on five periods after implementing VSM [18]

After made improvements to through elimination of losses mentioned above, it was built the current value stream map (Figure 1.3.6), [18].

After value stream map illustrated has identify value-creating activities, which are 63% from operational flow , represented 305 minutes from total of 485 minutes, and 37% are losses (muda), which represented 180 minutes [18].

After improvements, through implementation of advanced management techniques operational, value creating activities increased from 63% to 77%, an increase of 14% of the value creating activities, which represents a reduction of 14% of the losses [18].

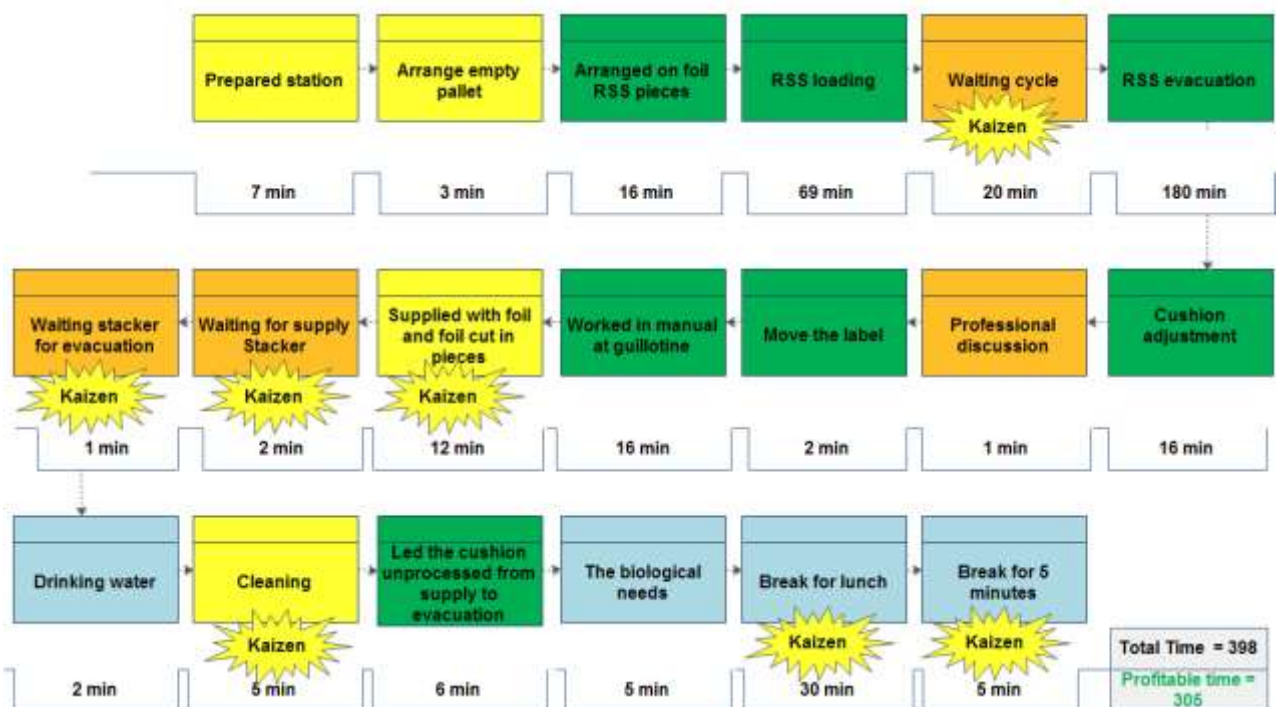

Figure 1.3.6. Current value stream mapping [18]

1.4. Lean tools – (kaizen) „A3 report” [19]

To analyze the production process of "driver control board" piece, achieving two A3 reports, each report separately using an instrument to achieve the proposed objective. In the first report, the Fishbone diagram was used in order to eliminate the “yellow foil”, and in the second report the Spaghetti diagram was used in order to reduce the transportation time of the product within the section [19] [174].

The results of the kaizen implementation consist of costs reduction, shortening of the routes for the products during fabrication process, more efficient organization of the storage zones [19].

Research Methodology

The research is carried out for the “driver control board” fabrication process, taking into account the increase of the economical efficiency and the elimination of risks, by means of losses identification and elimination [19].

In this case, these losses are caused by [18]:

- The “paper traveler” costs at assembly, necessary for the product identification;
- The transportation time of product within the section.

Two „A3 report” were made. In the first report, the Fishbone diagram was used in order to eliminate the “yellow foil”, and in the second report the Spaghetti diagram was used in order to reduce the transportation time of the product within the section. Thus, the first „A3 report” was aimed to reduce the costs by elimination of the yellow foil. These “yellow foils” are allocated to each product unit, which represented a high cost. These foils indicate the process that has to be carried out for each product unit. The total cost of the foils, the time spent for printing them and the costs of the printing cartridges are very high [19].

By means of the Fishbone diagram (figure 1.4.1) [19], the following negative aspects were identified [19]:

1. Human resource:
 - Supplementary costs for the filling operator.
2. Methods:
 - An automated tracking system is not allocated, for each unit it is necessary to print a “yellow foil”;
 - Complete the traveler for each process step.
3. Materials:
 - Cartridges are used to print the yellow foils;
 - Paper is consumed;
 - ESD foils are consumed.
4. Time evaluation:
 - Work time is lost because of foil filling.

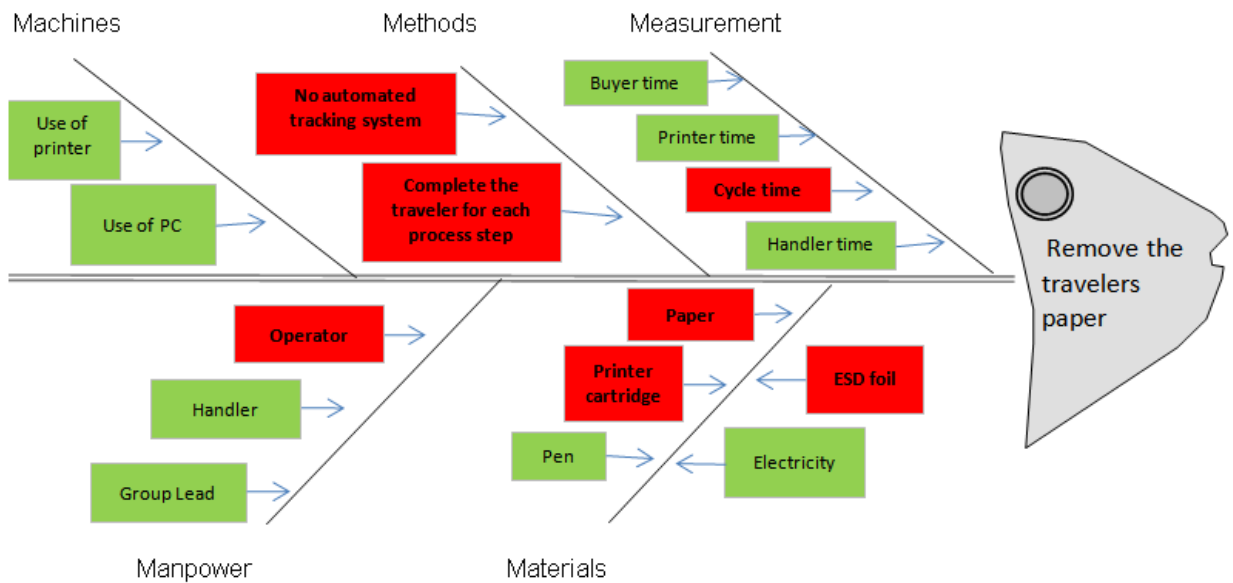

Figure 1.4.1. Fishbone diagram for the “travelers paper” analysis [19]

About this improvement action, one can distinguish the elimination of some tracking documents and product history along the fabrication process. The elimination of papers was made based on scanning of the respective information directly from the code marked on the product and on the administration by means of electronic product monitoring [19].

Figure 1.4.2 shows the practical way to organize the process, using an accompanying document for each plate (process before implementation of kaizen in area layout) [19].

The second „A3 report” was aimed to reduce the transportation time of product within section, by means of Spaghetti diagram, and the reduction of risks of product identification at final delivery [19].



Figure 1.4.2. Assembling process before kaizen, using “paper traveler” [19]

Figure 1.4.3 shows the process after the implementation of kaizen in order to eliminate “yellow foils” in area layout. All the units are now stored on the trays without using any Traveler. The automatic tracking system will help us to identify if the unit is at right operation or not [19].



Figure 1.4.3. Area layout after kaizen process [19]

Figure 1.4.4 shows, by means of Spaghetti diagram, the route of the packed product within section. It can be seen that there are two routes towards the checkpoint for three plate types. Also, the same storage areas are used to store various types of materials, which yields to the risk of mixing materials [19].

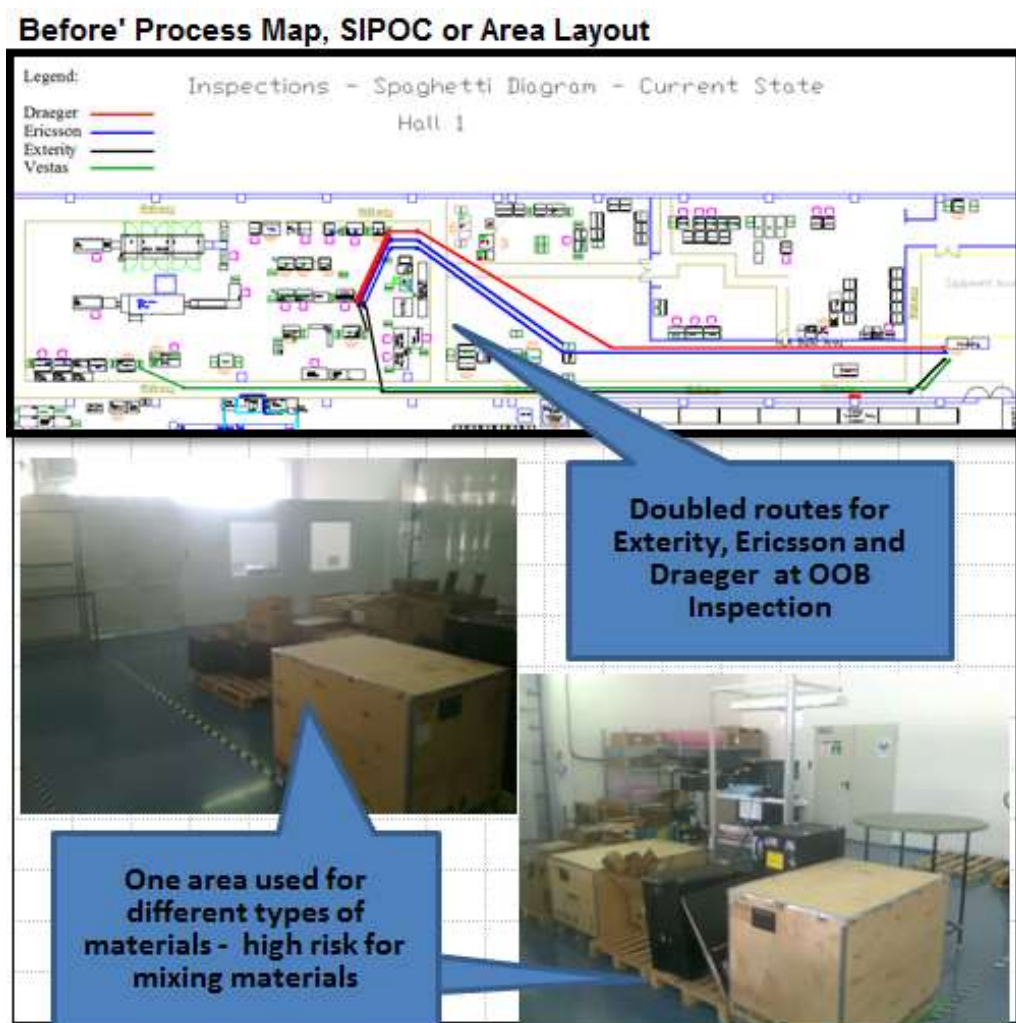

Figure 1.4.4. Spaghetti diagram, the initial route of the product within section [19]

Figure 1.4.5 shows the Spaghetti diagram after the implementation of kaizen procedure. The routes of the products in the fabrication process have been reduced. Also, storage zones have been settled for each type of material [19].

The implementation of kaizen procedure in the studied case implied [19]:

- Remove the all the travelers;
- Implement the automatically traceability system;
- Training for all the operators on how to use the new traceability system;
- Training for all the handlers on how many travelers need to be printed after this action.

Are presented the revenues and costs before and after kaizen implementation, as follows:

Cost reduction / year / soft [19]:

Before: 0 euro

After: 651,72 euro

Operator efficiency/year [19]:

Before: 156 days

After: 0 days

Financial Impact/year (Hard Savings) [19]:

Before: 0 euro

After: 5394,96 euro

The results of the kaizen implementation consist of costs reduction, shortening of the routes for the products during fabrication process, more efficient organization of the storage zones [19].

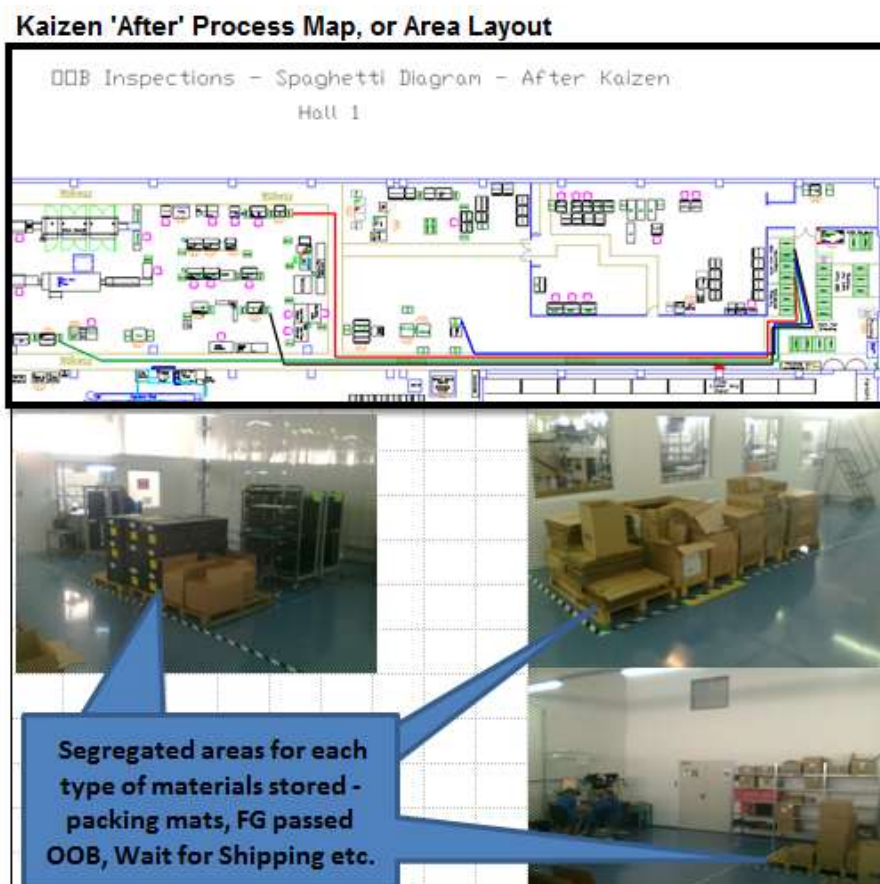

Figure 1.4.5. Spaghetti diagram, route of the product within section after kaizen implementation [19]

1.5. The optimization of decisions

The decision in modern activity of management industrial production is based on optimal solutions. The possibility of determining optimal solutions involving mathematical modeling of the problem and mathematical programming [11].

The research that I discussed, targeting optimization methods based on linear programming and fuzzy logic [11].

1.5.1 Optimization through linear programming [11]

In general in the scheduling technique from the operational management production field, the mathematical programming problem is a problem of maximizing or minimizing to a function (or several functions) of several variables, called goal function or objective whose variables satisfy a set restrictions expressed by equality or inequality [11].

The Matlab environment is composed of a series of standard programs written for mathematical calculations, modeling and numerical simulation, statistical data processing, computer-aided graphical representations. In addition it contains a mathematical optimization program group called "Optimum" [11].

The solving problems of minimal is made by „fmin” or „constr”. functions [11].

The "fmin" function is used for determine the minimum point for a function of a variable, with restrictions for the variable marginal [11].

The “constr” function determines the minimum point for a function of a several variables in a problem with restrictions over the variables. This function can be called according to the following options [11], [146]:

```
x = constr ('problema', x0);
[x, options] = constr ('problema', x0, options);
[x, options] = constr ('problema', x0, options, VMI,VMS);
```

The "Problema" is a Matlab file that returns two components: the objective function and the restrictions vector in the form [11]:

```
[F,G] = problema (x)
F – objective function;
G – restrictions [11], [146].
```

An order without ";" Will be interpreted and its result will be receive on screen [11].

It should be noted that Matlab solves only minimal problems [11].

To solve a maximum problem must be solved as a minimum problem, so the optimal value of the objective function will be opposite value to the displayed by Matlab [11].

Restrictions are interpreted as " \leq ". Therefore, all restrictions on the type or greater must be brought to canonical form more than or equal.. If there are restrictions of equality type then they must be first described in the coefficient matrix system of restrictions and their number is given by "options (13)" [11].

Application in the calculation of capacity production [11]

For an industrial company that produces two products P1 and P2 are required to be set per month the production capacity so as to cover the maximum available resources. To be made the two products are required three operations whose normal time and resources available are shown in Table 1.5.1, [11].

Table. 1.5.1 Data about production mix [11]

Operation	Norm of time needed to produce a unit of product [hours]		Available resources [hours]
	P1	P2	
Op 1	0.4	0.5	316
Op 2	0.5	0.3	354
Op 3	0.05	0.1	62

Optimization problem, mathematical model is [11]:

$$\text{Max}Z = 0.95 \cdot x_1 + 0.9 \cdot x_2 \quad (1.5.1)$$

where Z - the objective function;

x_1 - the quantity of products P1 that can be manufactured;

x_2 - the quantity of products P2 that can be manufactured.

With the following conditions [11]:

$$0.4 \cdot x_1 + 0.5 \cdot x_2 \leq 316 \quad (1.5.2)$$

$$0.5 \cdot x_1 + 0.3 \cdot x_2 \leq 354 \quad (1.5.3)$$

$$0.05 \cdot x_1 + 0.1 \cdot x_2 \leq 62 \quad (1.5.4)$$

$$x_1 > 0 \quad (1.5.5)$$

$$x_2 > 0 \quad (1.5.6)$$

```

1 function[f,g]=cp(x);
2 f=-0.95*x(1)-0.9*x(2);
3 g=[0.4*x(1)+0.5*x(2)-316,0.5*x(1)-0.3*x(2)-354,0.05*x(1)+0.1*x(2)-62,-x(1),-x(2)];

```

Figure 1.5.1. The "cp" file executed in Matlab [11]

Application designed in Matlab, function purpose and associated conditions are represented in Figure 1.5.1. The solving problem and sequences with related commands are represented in Figure 1.5.2, [11].

The results indicate a production of 708 products P1 and 65 products P2 covering 731 hours out of a total of 732 available hours [11].

```

File Edit View Web Window Help
Current Directory: C:\My Documents\costell\lucrari stiint

Command History
x=constr('cp',x0)
x0=[0,0]
x=constr('cp',x0)
cp(x)
x=constr('cp',x0)
x=fmincon('cp',x0)
help fmincon
x=fmincon('cp',x0)
x=constr('cp',x0)
cp(x)
x=constr('cp',x0)
cp(x)
x0=[0,0];
x=constr('cp',x0)
cp(x)

Command Window
>> x0=[0,0];
>> x=constr('cp',x0)

x =

    708.0000    65.6000

>> cp(x)

ans =

   -731.6400
  
```

Figure 1.5.2 Results of the optimization calculation [11]

We believe that this study may be helpful for decision makers, for those dealing with management, engineers or people from an organization that believes optimization problems that using mathematical programming that can facilitate the work to carrying out the complex tasks they have to perform [11].

From our experience draw the attention in solving problems with a large number of unknowns that computer system (PC) must possess a working frequency and enough memory, necessary of calculations from program [11].

1.5.2 Optimizing decisions using the fuzzy logic [12]

The conception and manufacturing process management are two aspects of integrated engineering have a definite contribution to this new approach to production in general and manufacturing in particular [12].

The classical approach of the issues related to authorization manufacture resort to two main categories [12]:

- Priority rules;
- The optimization criteria they ultimately causing objective (target) authorizing process.

Schematically, the classical decision making is described in Figure 1.5.3 [12].

Decisions which refers to authorizing considering technical objectives - economic (optimization criteria: C_1, C_2, \dots, C_k) - targets of the authorizing process. These objectives can be achieved using, in most cases one rule of priority [12].

This research proposes a procedure for authorizing the manufacture that uses a multiattribute decicizional type built with the help of fuzzy sets [12].

1.5.2.1. Classification of priority rules [12]

a. Notations used [12]

T- planning horizon (available production time);

t - time when the decision must be made;

n - number of product (orders) within system;

i - product index (order);

j - the index operation;

j (t) - immediately operation (below) for the "i" product, provided that the all operations j, where $1 \leq j < j(t)$, has been carried out;

TP_{ij} - The processing time at the "j" operation of "i" product;

TO_i - the total number of operations required execution of "i" product ($1 \leq j \leq TO_i, \forall i$);

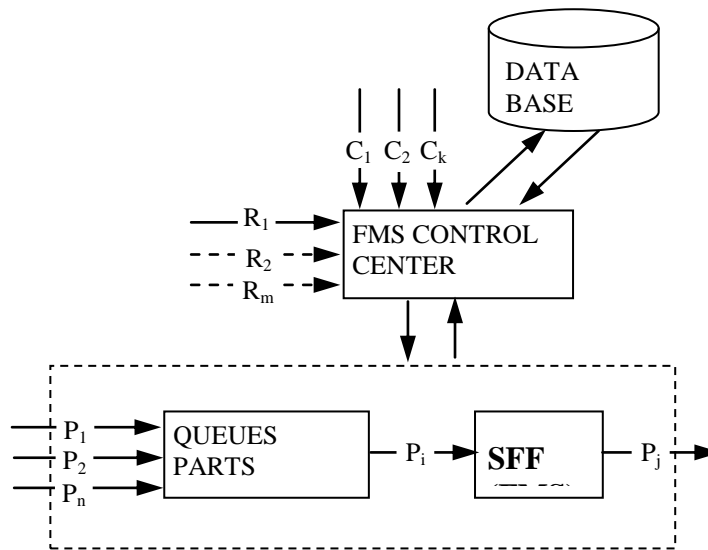

Figure 1.5.3 Classical decision making process [12]

TT_i - The total processing time of the "i" task;

$$TT_i = \sum_j TP_{ij}, \quad j=1, TO_i ; \tag{1.5.1}$$

$RO_i(t)$ - number of remaining operations for processing of the "i" product, at the "t" moment;

$RP_i(t)$ - Remaining processing time at the "t" moment, in the case of "i" product;

R_{ij} - the moment when the "i" product is ready for execution of the "j" operation;

R_{i1} - the moment when the product arrives in the system;

C_i - the moment when the "i" product was processed completely and leaves the system;

d_i - the deadline for the "i" product;

L_i - delay of the "i" product:

$$L_i = C_i - d_i \tag{1.5.2}$$

T_i - the delay of the product over delivery term:

$$T_i = \max(0, L_i) \tag{1.5.3}$$

F_i - the time interval that the product spends in the system (Flowtime):

$$F_i = C_i - R_{i1} \tag{1.5.4}$$

$S_i(t)$ - SLACK rule (reservation time):

$$S_i(t) = d_i - R_{ij} - TT_i \quad (1.5.5)$$

s_i - static reserves time:

$$s_i = d_i - R_{i1} - TT_i \quad (1.5.6)$$

b. Level I - piece selection [12]

At this decision making level will appeal to the priority rules used in authorizing problems approached in the classic way. These rules are grouped in three categories [12], [86]:

- I.a) Priority rules that depend on the product;
- I.b) Priority rules that depend on the operation;
- I.c) Priority rules that depend on some variable moment in time.

I.a) Priority rules that depend on the product (a.1- a.7):

I.a.1) Are selected the piece with the nearest delivery time - SDD (Shortest Due Date), that is [12]:

$$\min Z_i, \text{unde } Z_i = d_i \quad (1.5.7)$$

I.a.2) Are selected the product with the lowest initial of backup time (the lowest value of the static reserve) SSLACK, that is [12]:

$$\min Z_i, \text{unde } Z_i = s_i \quad (1.5.8)$$

I.a.3) Are selected the product with lowest of the ratios between the total time that the product spends in the system and initial reserve [12]:

$$\min Z_i, \text{unde } Z_i = \frac{d_i - R_{i,1}}{TT_i} \quad (1.5.9)$$

I.a.4) Are selected the product with the largest total processing time [12]:

$$\max Z_i, \text{unde } Z_i = TT_i \quad (1.5.10)$$

I.a.5) Are selected the product with the lowest total processing time [12]:

$$\min Z_i, \text{unde } Z_i = TT_i \quad (1.5.11)$$

I.a.6) Are selected the product that is the first ready for execution - FASFO (First At Shop, First Out) [12]:

$$\min Z_i, \text{unde } Z_i = R_{i,1}, i \in N_{i,j} \quad (1.5.12)$$

I.a.7) Are selected the most expensive product [12]:

$$\max Z_i, \text{unde } Z_i = VP_i \quad (1.5.13)$$

I.b) Priority rules that depend on the operation (b.1-b.14)[12]:

I.b.1) Are selected the product with the shortest imminent operation time –SIO (Shortest Imminent Operation time)

$$\min Z_i, \text{unde } Z_i = TP_{ij} \quad (1.5.14)$$

I.b.2) Are selected the product with the longest imminent operation time –LIO (Longest Imminent Operation time):

$$\max Z_i, \text{unde } Z_i = TP_{ij} \quad (1.5.15)$$

I.b.3) Are selected the product with the shortest remaining processing time –SRPT (Shortest Remaining Processing Time):

$$\min Z_i, \text{unde } Z_i = RP_i \quad (1.5.16)$$

I.b.4) Are selected the product with the longest remaining processing time –LRPT (Longest Remaining Processing Time):

$$\max Z_i, \text{unde } Z_i = RP_i \quad (1.5.17)$$

I.b.5) Are selected the product with the smallest value obtained by dividing the processing time of the imminent operation by the total processing time -SDT (Smallest value obtained by Dividing the processing time of the imminent operation by the total processing time).

$$\min Z_i, \text{unde } Z_i = \frac{TP_{ij}}{TT_i} \quad (1.5.18)$$

I.b.6) Are selected the product with the smallest value obtained by multiplying the processing time of the imminent operation by the total processing time - SMT (Smallest value obtained by Multiplying the processing time of the imminent operation by the Total processing time):

$$\min Z_i, \text{unde } Z_i = TP_{ij} TT_i \quad (1.5.19)$$

I.b.7) Are selected the product with the largest value obtained by dividing the processing time of the imminent operation by the total processing time - LDT (Largest value obtained by Dividing the processing time of the imminent operation by the Total processing time):

$$\max Z_i, \text{unde } Z_i = \frac{TP_{ij}}{TT_i} \quad (1.5.20)$$

I.b.8) Are selected the product with the largest value obtained by multiplying the processing time of the imminent operation by the total processing time - LMT (Largest value obtained by Multiplying the processing time of the imminent operation by the Total processing time):

$$\max Z_i, \text{unde } Z_i = TP_{ij} TT_i \quad (1.5.21)$$

I.b.9) Are selected the product with the fewest number of remaining operations - FRO (Fewest number of Remaining Operations):

$$\min Z_i, \text{unde } Z_i = RO_i \quad (1.5.22)$$

I.b.10) Are selected the product with the largest number of remaining operations - LRO (Largest number of Remaining Operations):

$$\max Z_i, \text{unde } Z_i = RO_i \quad (1.5.23)$$

I.b.11) Are selected the product with the least amount of slack - SLACK (least amount of slack):

$$\min Z_i, \text{unde } Z_i = S_i \quad (1.5.24)$$

I.b.12) Are selected the product with the smallest ratio of slack time to the number of remaining operations - SLACK/RO (smallest ratio of slack time to the number of remaining operations):

$$\min Z_i, \text{unde } Z_i = \frac{S_i}{RO_i} \quad (1.5.25)$$

I.b.13) Are selected the product with the smallest ratio of job slack time to the total processing time (smallest ratio of job slack time to the Total processing Time):

$$\min Z_i, \text{unde } Z_i = \frac{S_i}{TT_i} \quad (1.5.26)$$

I.b.14) Are selected the product with smallest ratio of job slack time to the remaining processing time SLACK/RP (smallest ratio of job slack time to the Remaining Processing time):

$$\min Z_i, \text{unde } Z_i = \frac{S_i}{RP_i} \quad (1.5.27)$$

I.c) Priority rules that depend on some variable moments in time [12]

I.c.1) Are selected the product which entered first into the standby machine system - FIFO(First In, First Out):

$$\min Z_i, \text{unde } Z_i = R_{ij}, i \in N_{ij} \quad (1.5.28)$$

1.5.2.2. Decision-making procedures [12]

a. Stages of decision-making procedure [12]

Overall decision process is described in figure 1.5.4 [12].

The highlight the next steps-specific both the level I and level II)

- i-determined inputs;
- ii-fuzificare;
- iii- fuzificate entries (vague);
- iv-inference scheme;
- v-conclusion (vague);
- vi-defuzzification;
- vii - determined output.

b. Priority rules. Criteria for the assessment [12]

The peculiarities ordering based of fuzzy sets would be follows [12]:

- Can be discussed at some point, several priority rules. These rules will define them as inputs into decision-making system (Figure 1.5.4).
- Entry into the decision making reflects the state of the manufacturing system when it comes to determining the order-processing, in fact characterize each product that requires processing system. For the case of a decision making based on fuzzy entries called evaluation criteria.

c. Linguistic variables. Linguistic degrees [12]

The products that require processing on a particular machine will be treated as possible options [12].

Each criterion is assigned a linguistic variable that will designate "Evaluation of "i" version in the "j" criterion" j "." [12].

For each linguistic variable is defined the linguistic degrees or linguistic terms. These will serve to characterize the "vague" of determined information [12].

d. Membership functions [12]

Correlation between determined value and linguistic variable and the linguistic levels considered is accomplished through membership functions. These may have different forms of representation [12], [96], [110].

The determined values they will correspond to certain degrees of membership values based on the level language (linguistic term) in which they are reported. Establishing the degree of belonging is done through the process of fuzificare [12].

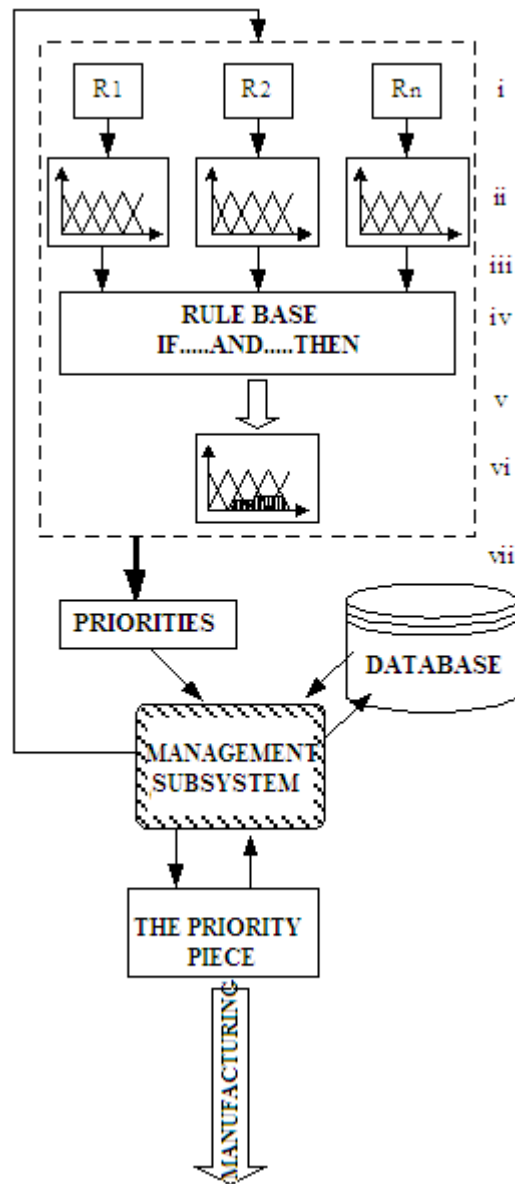

Figure 1.5.4 Decision making process with fuzzy sets [12]

e. Establish the method for connect different values of membership functions [12]

By this stage it was revealed how the determined values of the input quantities characteristic of a product respectively a car can be fuzificate [12].

Next will need these values of the degrees of membership (entry fuzificate) may be aggregated. Inference is done using a rule base. The rules, called inference rules have the general form [12]:

$$\mathbf{IF} \text{ (premise) } \mathbf{THEN} \text{ (conclusion)} \quad (1.5.29)$$

The conclusion is a vague information expressed through the *linguistic degrees (linguistic terms)* that are associated to the linguistic variable describing vague the exit from fuzificare system if the premise is satisfied [12].

After evaluating the current rules will move to the connect of values of the membership functions derived from an assessment of each active rules. The result of inference is the vague value of the output quantity [12].

The connection method is the MAX-MIN method . In general this method is defined as:

Or R_1 and R_2 two fuzzy relations, where [12]:

$$R1 : X \times Y \rightarrow [0,1]; \tag{1.5.30}$$

$$R2 : Y \times Z \rightarrow [0,1]; \tag{1.5.31}$$

Connecting (composing) the vague relations R1 and R2 in the form [12]:

$$R1 \circ R2 : X \times Z \rightarrow [0,1] \tag{1.5.32}$$

The evaluation through the MAX-MIN product according to the relationship [12]:

$$\mu_{R1 \circ R2}(x, z) = \text{MAX}(\text{MIN}(\mu_{R1}(x, y), \mu_{R2}(y, z))), \tag{1.5.33}$$

cu $(x, z) \in X \times Z$ si $y \in Y$

f. Defuzzification [12]

The variable output of the inference process will have a value that depends on the values of input variables. But the values of input variables were fuzificate (are vague), so the values of the output variables will be vague [12].

For defuzzification is used one of the presented methods in [12], [96], [110].

Between defuzzification methods is proposed using the centroid method. Shall apply the next formula [12]:

$$A_{Rez} = \frac{\sum_{i=1}^r w_i c_i I_i}{\sum_{i=1}^r w_i I_i} \tag{1.5.34}$$

where:

A_{Rez} - the final appreciation; r - number of active rules; w_i - the share (credibility) of "i" rule; I_i - output fuzzy surface area to corresponding to the "i" rule; c_i - abscissa of the center of gravity of the output fuzzy surface corresponding to the "i" rule [12].

g. Interpretation of results

For the products pending will applied the procedure above described, which results from the procedure described results in a number of priorities for each of the rows representing the time priority of a pending items of the resulting string is ordered to obtain the order of entry product in the system [12].

1.5.2.3. Case study

a. The input data in the decisional process [12]

The authorizing procedure will be explained to the processing of two pieces types for each of the three flexible manufacturing system machine [12].

The Information that entering in the decision process are summarized in Table 1.5.2. These relate to processing times on each machine of each type of piece [12].

Table 1.5.2 The processing times on each machine of each type of piece [12]

Processing time (PT) [min]	Machine - M1	Machine - M2	Machine - M3
Piece-P1	20	15	30
Piece-P2	15	35	20

b. The value ranges of criteria (rules) relative is carried out to authorization [12]

For the processing time, the longest of a piece to the next operation, the adopted value is [12]:

$$LIO = [10; 40] \text{ [min];}$$

For the longest remaining processing time (LRPT) the value domain is:

$$LRPT = [20 \ 100] \text{ [min]}$$

c. The linguistic variables used [12]

It will adopt the following linguistic variables [12]:

- Maximum processing time (LIO);
- Maximum remaining processing time (LRPT).

d. The procedure for calculating the parameters input in the decisional process [12]

To calculate the parameters that are used in decision-making through the steps [12]:

- Calculation of the total processing time;
- Calculation parameters LIO and LRPT at the M1 and M2 machine
- Carrying the decision making process itself.

e. The decisional procedure [12]

The decisional procedure itself is done using the Fuzzy toolbox of Matlab programming environment. In Figure 1.5.5 is presented the inference system [12].

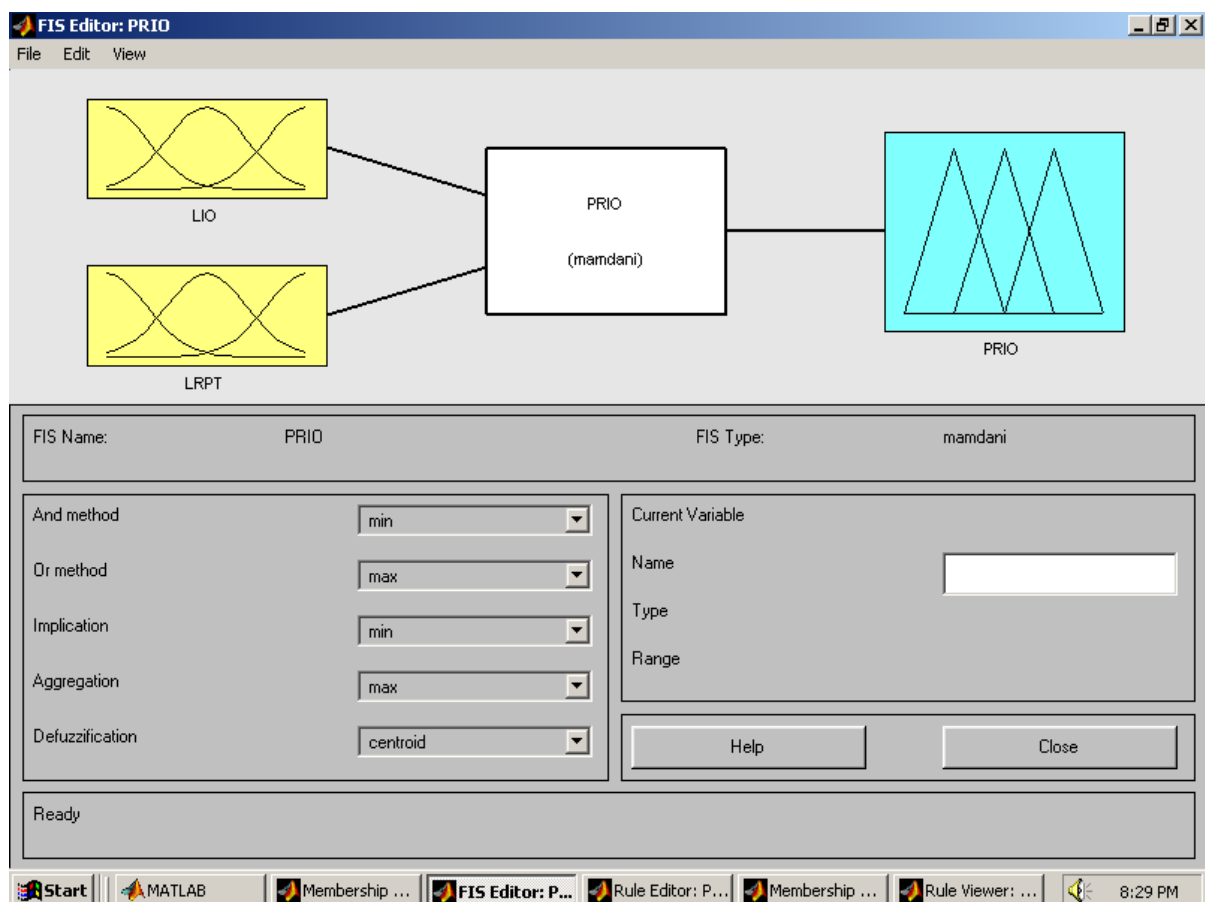

Figure 1.5.5 Fuzzy inference system [12]

In the figure 1.5.6 are presents the inference rules as membership functions assigned to each linguistic degree corresponding to the two input variables, namely the output variable [12].

f. Results interpretation [12]

Looking at the results in Table 1.5.3 it is found the following [12]:

- On machines M1 and M3 the highest priority have the P1 pieces;
- At the M2 machine the highest priority have the P2 pieces.

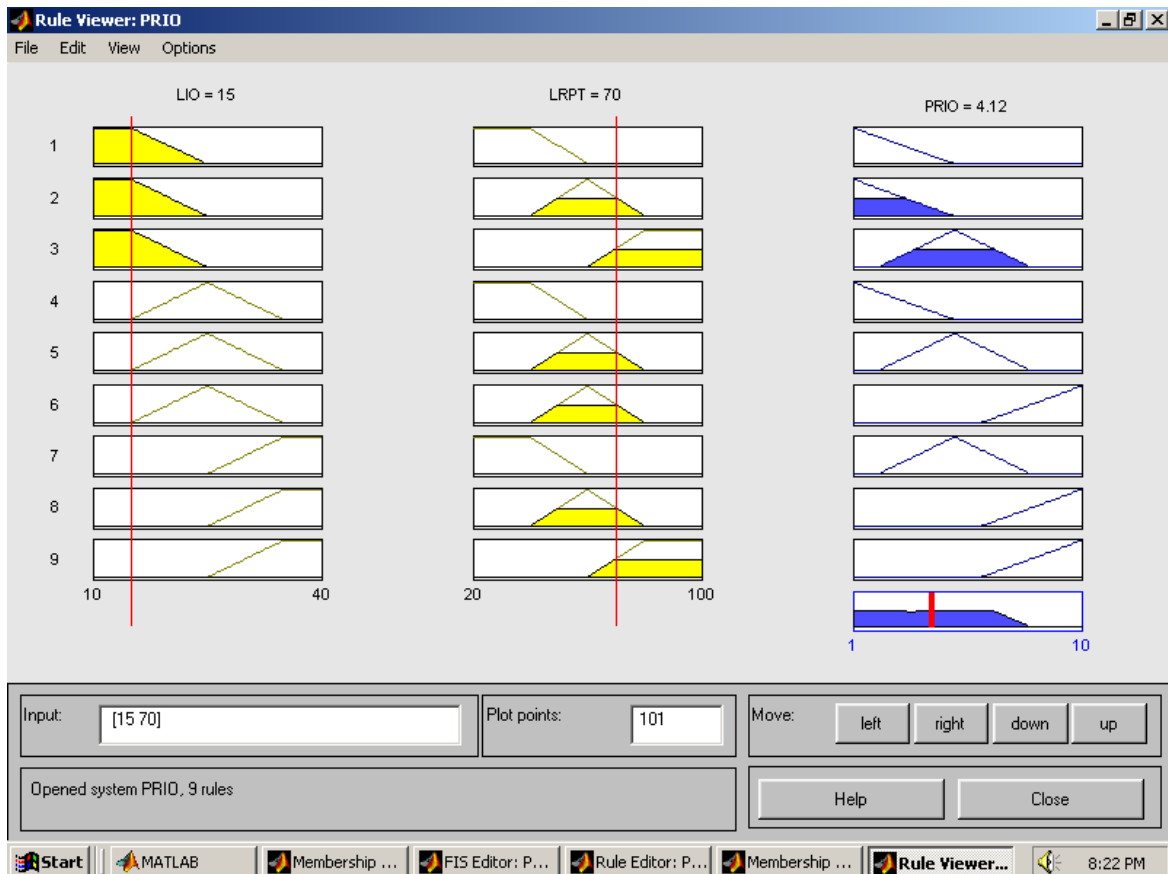

Figure 1.5.6 Inference rules [12]

Table 1.5.3 The results of processing times on each machine of each type of piece [12]

PIECES	PARAMETER	Machine M1	Machine M2	Machine M3
P1	LIO [min]	20	15	30
	LRPT [min]	65	45	30
	PRIO	5,45	2,38	4,12
P2	LIO [min]	15	35	20
	LRPT [min]	70	55	20
	PRIO	4,12	7,16	2,53

Use of multiattribute decision making based on fuzzy type procedures, in the authorizing the manufacture offers new opportunities for development. These possibilities relate to the simultaneous use of a number of criteria in relation to make prioritization of processing parts and the selection of the machines that will be done the processing [12].

2. CONTRIBUTIONS TO INCREASE THE PRODUCTIVITY OF PROCESSES AND WORKING MACHINES

2.1. Contributions and research in MUCN retrofitting

There are three possibilities to intervene on an existing machine tools, so it will acquire the higher productivity and quality parameters, as follows:

- A. Rebuilding the machine;
- B. Remanufacturing the machine;
- C. Retrofitting the machine.

A. Rebuilding means repairing broken elements, even replacing them by disassembling the machine and reassembling it. This brings it to at least the initial parameters, if not better ones. Some operations are done in collaboration, such as the correction of commands. This is usually about the mechanical rebuilding of the machine [53].

B. Remanufacturing is about building a new machine on the framework of an existing one. The parameters of the new machine will be better than those of the old one. The costs of such an operation are very high, reaching 70-75% of the price for a new machine. Remanufacturing also includes the refitting of smaller elements and may need re-designing some subassemblies. In some cases, the numerical commands of these machines are replaced, which may take up to one year. Some numerical commands may be replaced with better ones [53].

C. Retrofitting means an improvement of controlled elements (CNC), main drives, advance and accessory drives, such as ball screws, their drives, measurement elements (rulers, converters etc.), electrical and electronic commands connected to the newest CNC equipment. Retrofitting is done on the location where the machine is found, so the machine subassemblies do not need to be moved. Its duration and costs are much lower than for the previous two methods [53].

The Faculty of Management and Tehnological Engineering (IMT) from University of Oradea are trying to develop on own forces the newest and most modern laboratory of computer integration manufacturing, based on retrofitting activities [53].

This laboratory will cover all the study levels (bachelor, master and PhD), having the main technical characteristics of the most advanced technological concepts as follows: five axes machining, computer assisted of the main technological flow, CAD-CAM, etc [53].

The laboratory will contains one Flexible Manufacturing Cell (FMC), two Robots, one special Conveyor, Regal Lager, Load-Unload Station for parts and tools, all these computer assisted and survived by the students, using one hierarchic net [53].

The undertaken research shows the main aspects of the resources flow, which will be installed over the FMC, in order to assures the automatic regime [53].

The automatic regime at the FMC is based on resources flow, having the possibilities to adapt, to organize, to modify, to simulate all the virtual situations on the working place before the starting into manufacturing process. The resources flow need to be assured at the entry into the FMC, regarding the following resources objects: load-unload of different working parts (depending the manufacturing request), load-unload of different tools, load-unload of different CNC programs, load-unload of different other materials [53].

The main resources flow components in the case of the FMC for the prismatic parts

machining are [53]:

- 1) Working parts fixed on the fixtures, which are introduced together into the machining/cutting process, but on the base of manufacturing request and computer ordering/launching;
- 2) Tool-set of each working part, prepared before the machining start up;
- 3) CNC programs launching into the run process, on the base of the CAPP simulation (Computer Aided Production Planing)
- 4) Other materials as: cooling liquid, chip evacuation, liquid for washing, etc.

The Flexible Manufacturing Cell UO-01 FMC is developed by retrofitting from one horizontal machining centre (produced by UCIMU-Italy, UO-01 FMC) on own forces of the IMT Faculty [53].

The retrofitting activity at this machine regards the following main parts/ activities /functions [53]:

- the changing of the CNC unit from Siemens 3M to Fanuc 30i – five axes;
- the changing of the motors/servomotors and drives with the newest AC-digital generation from Fanuc;
- the integration of 2 CNC axes rotary-tilting table as complementary 2 axes and as detachable manufacturing unit of the basic machine working table (on the board of the machine pallet system);
- the integration of one modular automatic fixture system, able to be loaded-unloaded assisted by robots as AWPC (Automatic Work piece Changing) function supplementary against the actual APC (Automatic Pallet Changing) function;
- the integration of one modular tooling system in order to assures the ATR function.



Figure. 2.1.1 The general view on the actual laboratory [53],



Figure 2.1.2 – (left over) -The APC at the UO-01 FMC machine, [53],



Figure 2.1.3 – (left) - The old CNC unit Siemens Sinumerik 3M, [53],



Figure 2.1.4 – (over) - The ATC unit chain type and hydraulic manipulator, [53],

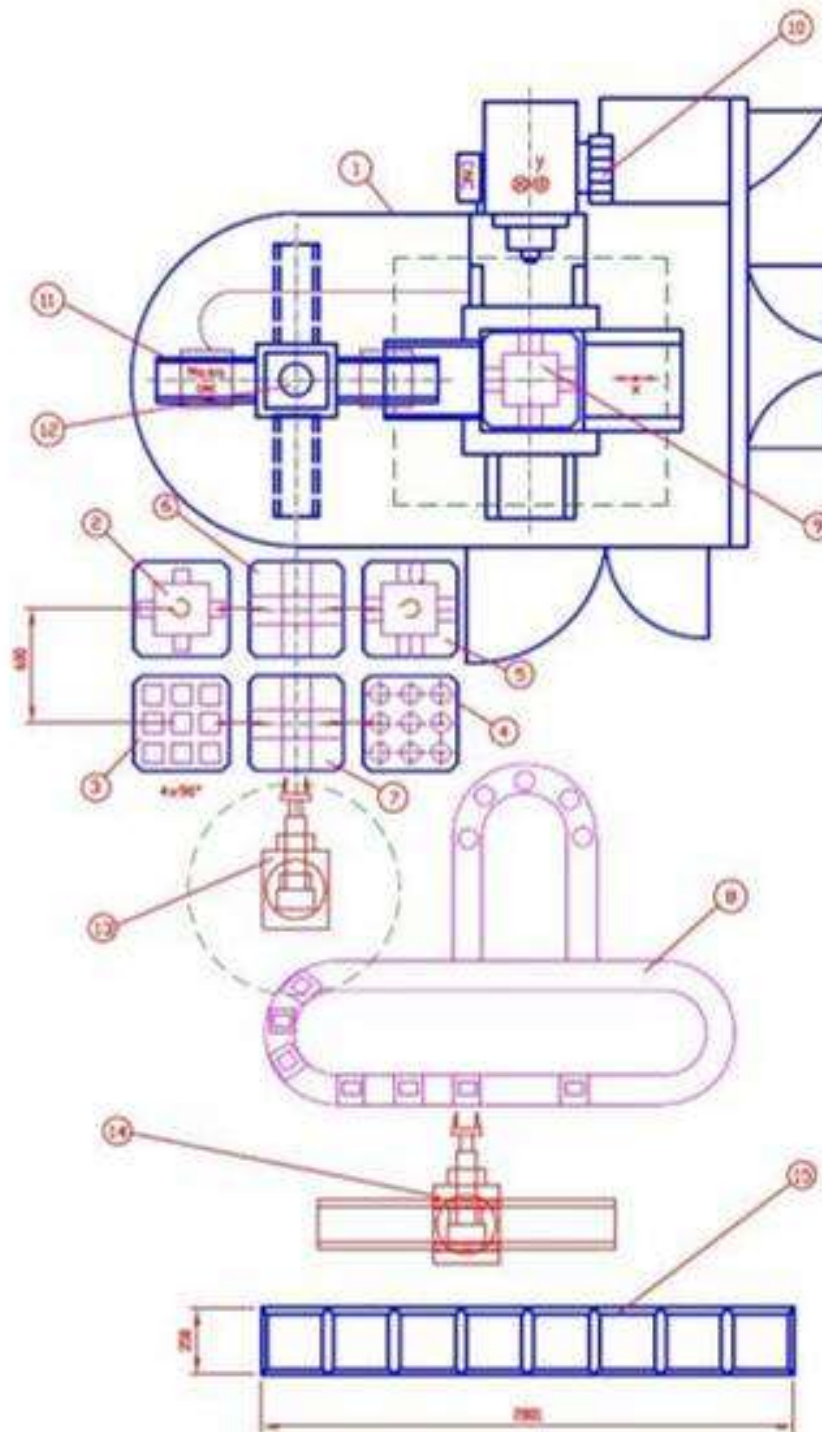

Legend

- 1-Flexible manufacturing cell TMA-AL550
- 2-Tombstone Fixture Load station
- 3-AVPC temporary magazine
- 4-ATR temporary magazine
- 5-ATR Tool support Load station
- 6-Pallet Load/Unload station
- 7- Tool offset caption station

- 8-Conveyor
- 9-Working table
- 10-Automatic tool changing
- 11-2 axes rotary table as detachable unit
- 12-Automatic pallet changing
- 13,14-Robot
- 15-Regal Lager

Figure 2.1.5 – The new layout regarding the future UO-01 Flexible Manufacturing Systems (FMS developed by retrofitting, [52], [53])

The basic machine center (1) will be equipped with FANUC CNC control, APC with four

positions, load station for working parts on tombstone fixture (2), load station for tools on detachable support (5), pallet station with the access to APC (6), working parts support (3), tool support (4), off-set caption station (7), robot (13) and (14), conveyor (8), regal lager (15), [53].

On the second pallet of the machine APC is disposed the 2-axes CNC rotary table as detachable unit [53].

(Automatic Tool Readjustment), supplementary at the actual ATC (Automatic Tool Changing) function, [50], [51], [53], [91].

It can be find some detailed pictures over the actual machine as in the figures 2.1.1 to 2.1.4, and respectively the new layout at the entire future FMC from this laboratory [53].

Regarding the resources flow at the FMC, the following components of this flow can be showed [53]:

1. The working parts flow from Regal lager (15) to FMC (for not machined parts) is: Regal lager (15)– Robot nr.1 (14) - conveyor (8) – robot nr.2 (13) – part temporary support (3) – robot nr.2 (13) – tombstone fixture (2) – pallet on load station (6) – APC (12) – machine working table (9), and respectively the back way to the Regal lager (for the finished parts): machine working table (9) – APC (12) – pallet on unload station (6) – tombstone fixture at unloading (2) – robot nr.2 (13) – conveyor (8) – robot nr.1 (14) – Regal lager (15).

2. The tools flow for ATR function: Regal lager (15) – Robot nr.1 (14) – conveyor (8) – robot nr.2 (13) – tool temporary support (4) – robot nr.2 (13) – off-set station (7) – tool detachable support (5) – pallet load station (6) – APC (12) – machine working table (9) – machine main spindle – ATC manipulator (10) – ATC magazine (10), and respectively the back way to the Regal lager (for unused tools): ATC magazine (10) – ATC manipulator (10)– machine main spindle – detachable tool support on working table (9) – APC (12) – pallet unload station (6) – tool unload station (5) – robot nr.2 (13) – conveyor (8) – robot nr.1 (14) – Regal lager (15).

3. The programs flow is separate flow between DNC hierarchic computer and the other control units (CNC of the FMC, PLC of the robots, PLC of the conveyor, PLC of the load-unload station conveyor. All the programs are resident on which control unit; the orders to run will be done selectively depending the current stage of the machining, on the base of the CAPP function at the DNC level.

4. Other material flow (cooling liquid, chip evacuation, liquid for washing, etc) will be introduced on programmable selection from which part program.

The reduction of the consumption of material used for the building of the machine creates sustainable effects in the machine industry, starting from: ore extraction (negative impact upon the underground resources), melting ore to obtain steel or crude iron (energy consumption), casting or iron (energy consumption), mechanical processing upon the chassis or the composing elements (energy consumption), transport to beneficiary (energy consumption), [21].

Increasing the processing accuracy (quality) has effects in reducing environmental impact and creating a more sustainable industry by diminishing waste (additional consumption of energy, of materials) both for the producer and for the beneficiary [21].

The increase in productivity determines sustainable effects such as the reduction of the number of machines that are necessary for production (material consumption), [21].

Last but not least, a higher exploitation safety and the fact that the operator's work becomes easier also contribute to a more sustainable result [21].

In the table 2.1.1 is presented centralized the pozitiv sustainable impact obtained after retrofitting [21].

Table 2.1.1 The benefits in terms of sustainability when the retrofiting is applies [21]

No.	Retrofitted sub- assembly	Operation	Positive impact Sustainable result (SR)	Obs.
1	Chassis	Touching up conductors + rebuilding of the table setting surface	Cost reduction for making a new chassis; SR: - reduction in energy consumption (necessary for the chassis casting) and saving ferrous material;	Positive impact
2	Automation on the axes: X,Y,Z,W, A, B	Replacing classical feed-screws with ball screws and screws with adjustable nut	Increase in productivity and quality (higher processing speeds); SR: - decrease of energy consumption and material consumption, by reducing the add-ons;	Positive impact
3	Electrical commands	Rebuilding of the electrical cabinets, using command elements of high performance	Increase in productivity and quality; SR: - increase in the service period; - the machine is not damaged so often; - more safety in exploitation;	Positive impact
4	CNC command	Replacing numerical command (NC) with the newest CNC	Increased precision, productivity and quality; SR: - fewer possibilities of damage, usage of performance elements;	Positive impact
5	Introducing closed loops (negative reaction loops) in the machine drives	Systems with self-Diagnose of MUCN, by automatically adjusted circuits that use: moving transducers, pressure transducers, temperature detectors, rotary transducers.	Improvement of the processing accuracy at high chipping speeds. The traditional method of increasing the stiffness is solved, from a constructive point of view, by an increase in the chassis mass or hydraulic compensation. SR: - reducing the weight of the machine, which is necessary for an adequate stiffness to work for mechanical processing, therefore determining a lower material consumption. - reduction of scrap caused by low precision	Positive impact

2.2. The precision studies of the cnc machining centers

2.2.1. The precision analysis of the CNC machining center in static conditions

In order to achieve high accuracy within the CNC machine tools, as sample: the lathes and milling machines, by using of various methods of verification and control, one important role is the checking of the positioning accuracy on the 3 linear axes. This linearity is associated with the machine horizontality because the measurement instrument can be spirit leveling device. [20], , , , .

This measurement of linearity is followed by checking the accuracy of the positioning with laser and the errors compensation. [20], [75], [89], [101].

For the determination of the linear displacement on X, Y, Z axes at machining centers are used conventional and unconventional methods of control [20].

a. Conventional methods of checking the linearity and flatness deviations at the machining centers

Bellow are presented a few conventional methods for the determining of the linearity deviations of axes at machining centres such as: determination by spirit leveling device, wire collimator, wire auto-collimator and yardstick ruler. On the measurements realized with spirit leveling device, wire collimator, wire auto-collimator and yardstick ruler, the standard step is either 200 mm. On the figure 2.2.1 is presented a conventional measurement realized with spirit leveling device on Z axes at the horizontal machining centre UO-01 FMC. [20], [49], , .

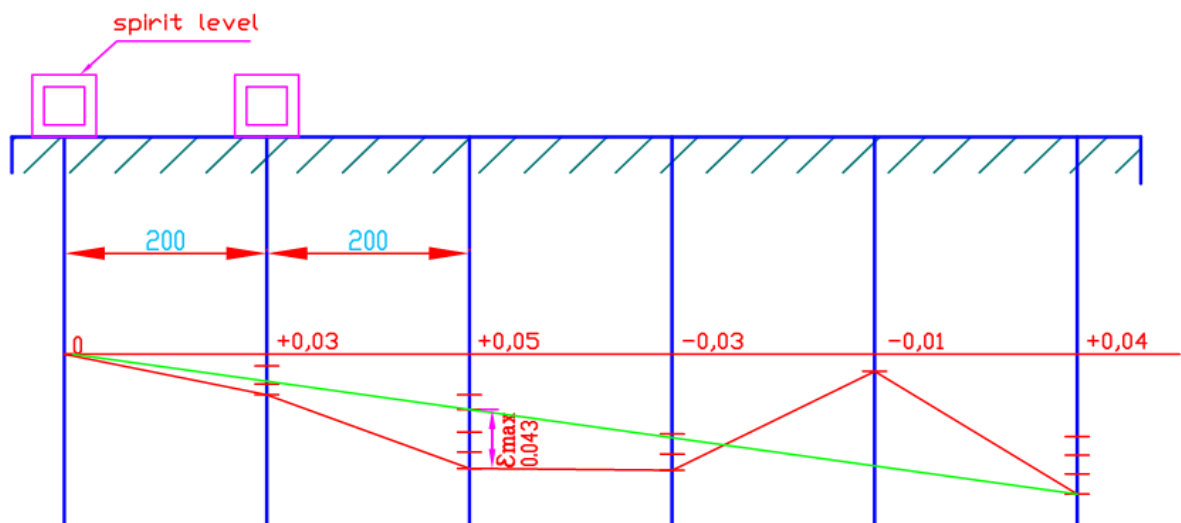

Figure 2.2.1 Linear measurement on Z-axis at the horizontal machining centre UO-01 FMC realized with spirit leveling device [20], [49]

On the figure 2.2.2 [20] is presented a conventional measurement method based on wire collimator and applied on Z axes at the horizontal machining centre UO-01 FMC.

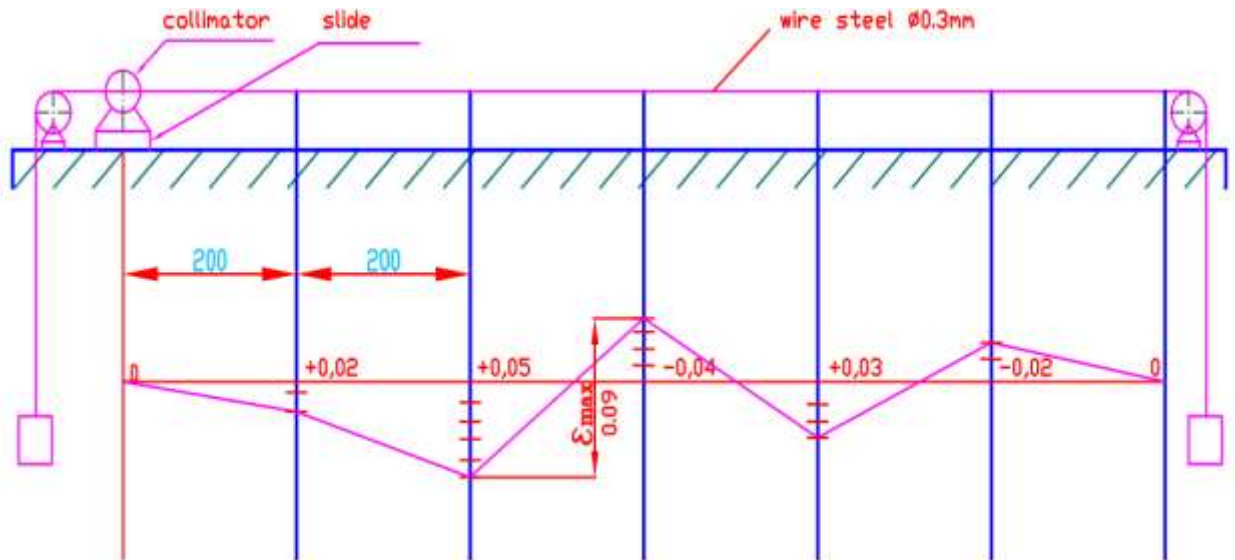

Figure 2.2.2 Linear measurement on Z-axis at the horizontal machining centre UO-01 FMC realized with wire collimator [20], [49]

On the figure 2.2.3 [20] is presented a conventional measurement for the linear measurement on Z axes at the horizontal machining centre UO-01 FMC realized with auto-collimator.

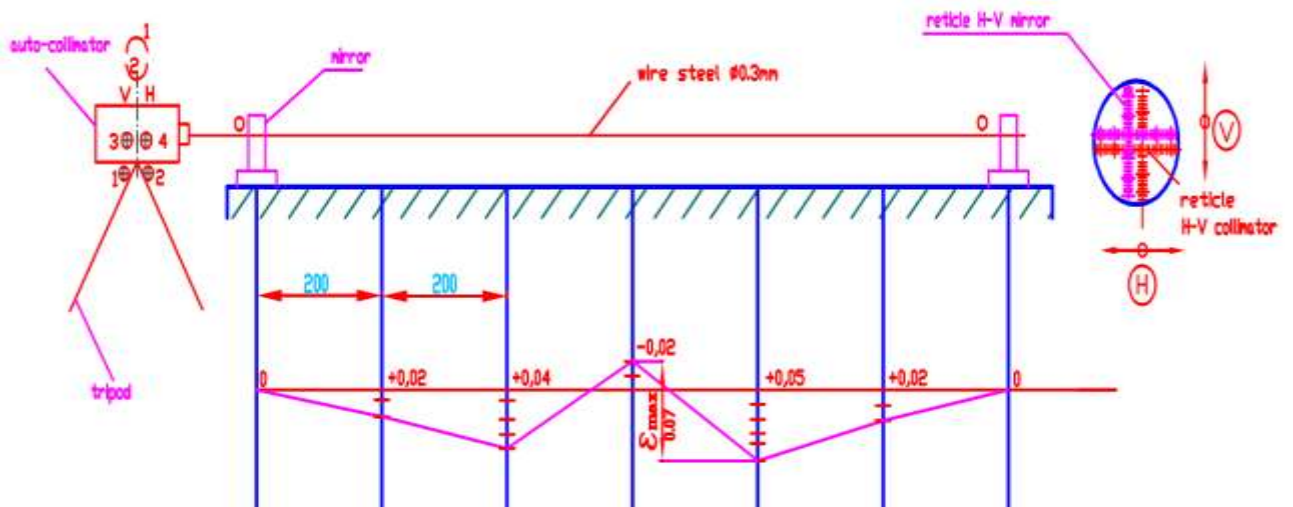

Figure 2.2.3. Linear measurement on Z-axis at the horizontal machining centre UO-01 FMC realized with wire auto-collimator [20], [49]

On the figure 2.2.4 [20] is presented a conventional measurement for the linear measurement on Z axes at the horizontal machining centre UO-01 FMC realized with yardstick ruler.

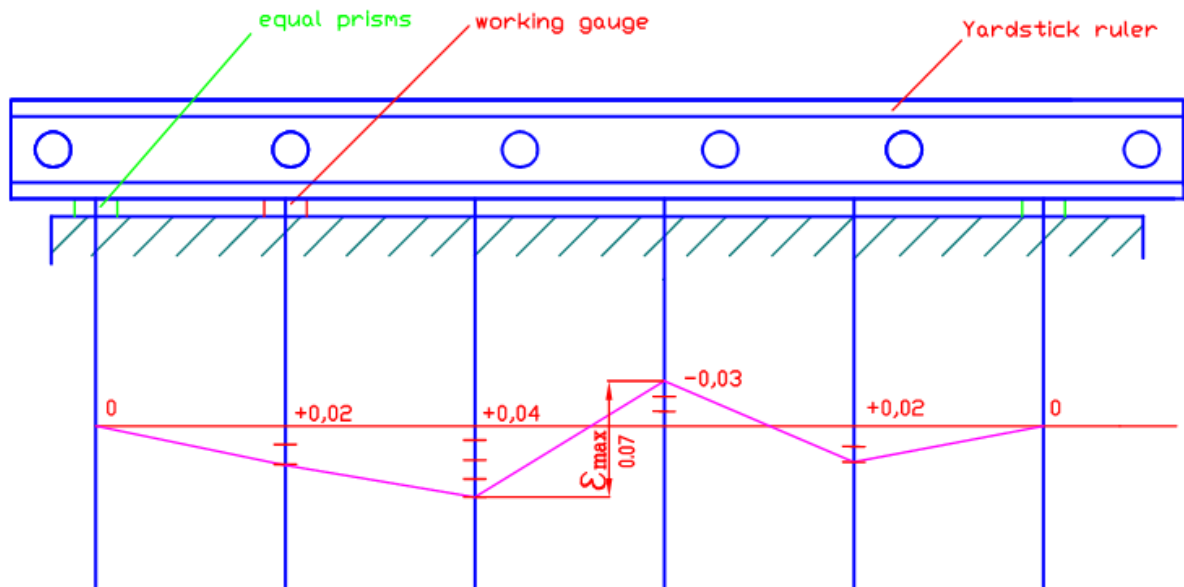

Figure 2.2.4 Linear measurement on Z-axis at the horizontal machining centre UO-01 FMC realized with yardstick ruler [20], [49]

b. Unconventional methods for determining the linearity at machining centers

Due to the use of the laser on increasing scale in industry, an application is for linearity and calibration measurements of machines tools. Figure 2.2.5 represents the XL 80 laser system realized by Renishaw who provides an accuracy of ± 0.5 ppm which is constant for the entire range of operating conditions by variations in temperature, pressure and humidity. The figure 2.2.6 presents the optic elements used for linear measurement composed by: linear reflector, beam splitter and targets. [20], [127], [128], [129].



Figure 2.2.5. Laser XL 80 with tripod and support [20], [127]



Figure 2.2.6. Optic elements for linear measurement [20], [128]

c. Case Study on the achievement of linear measurements on Z axis at the horizontal machining center UO-01 FMC.

By means of this laser which is found in the equipping of the machine tools laboratory from University of Oradea, we made the experimental research to determine the linear positioning at horizontal machining center UO-01 FMC [20].

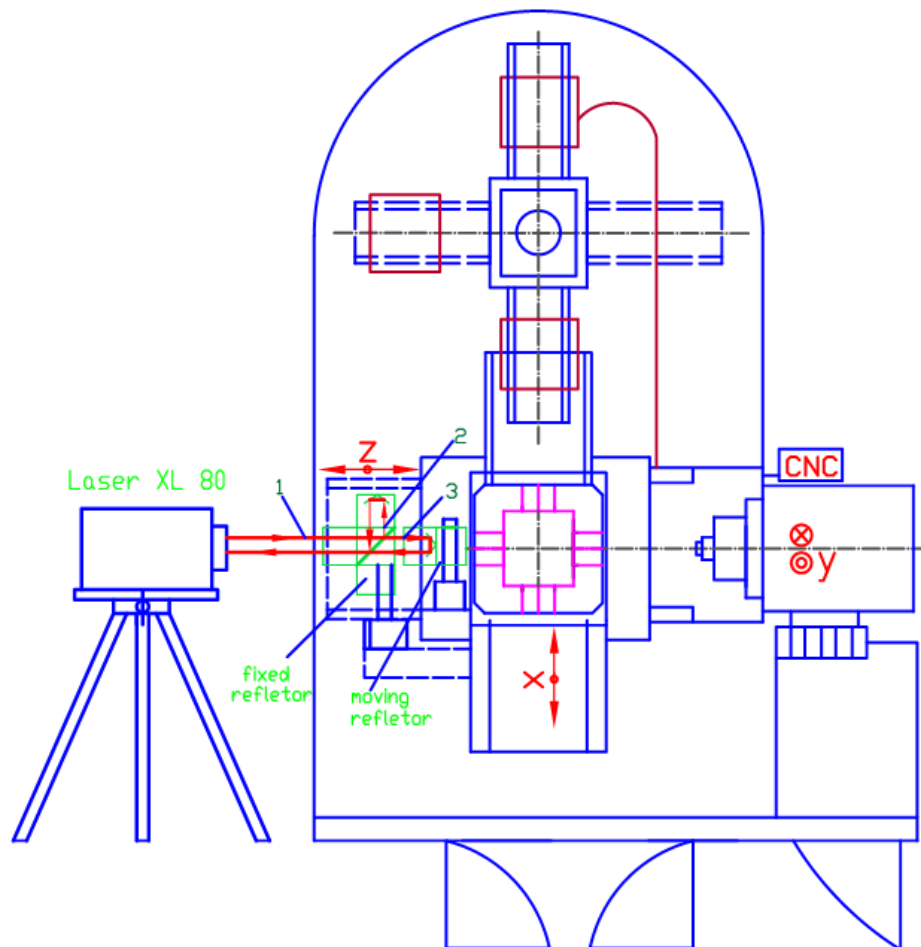

Figure 2.2.7 Principle of linear measurement on Z Axis with Renishaw laser XL 80 at the horizontal machining centre UO-01 FMC [20] [128]

On the figure 2.2.7 [20] is presented the view layout of the principle of linear measurement realized at the horizontal machining centre UO-01 FMC by the XL 80 laser interferometer on Z axes, the laser beam (1) start from the head of the XL 80 laser and is moving to the beam splitter where is split in two components:

-the reflected beam (2) is a vertically light who is transmited to the beam (3) which is a horizontally light [20].

These two reflectors reflect the beam (2) and (3) to the beam splitter, one reflector is fixed on the table of machining centre and the secod is moving bidirectionaly on Z axes as being at 0 mm to 350 mm [20].

To achieve the program for linear measurement is necessary to know the length of Z axis, which is 350 mm within the realized measurements having the established measuring range as being of 50 mm, and also the software will calculate automatically the number of targets.

In this case of measurement which are realized in both ways of displacement the number of targets is 8 [20].

The programme realized by the laser software is saved in Word Pad then is transmitted through memory stick to the CNC of the machine UO-01 FMC and the form represented on table 2.2.1. [129], [20].

Table 2.2.1 Part program for linear measurements on Z axes realized by Laser XL 80 software [20]

```
%
O0023
(ERROR COMPENSATION RENISHAW)
N0030 G01 G94
N0040 G90 F1000
#1=0
#2=1
N0070 (LOOP START)
G01 Z000.000
G04 X4.
G01 Z50.000
G04 X4.
G01 Z100.000
G04 X4.
G01 Z150.000
G04 X4.
G01 Z200.000
G04 X4.
G01 Z250.000
G04 X1.
G01 Z300.000
G04 X4.
G01 Z350.000
G04 X4.
G04 X4.
G01 Z350.000
```

```

G04 X4.
G01 Z300.000
G04 X4.
G01 Z250.000
G04 X4.
G01 Z200.000
G04 X4.
G01 Z150.000
G04 X4.
G01 Z100.000
G04 X4.
G01 Z50.000
G04 X4.
G01 Z000.000
G04 X4.
#1=#1+1
IF [#1 NE #2] GO 70
M30
%
```

In figure 2.2.8 [20] represents the head of XL 80 laser (1) with reflection mirrors (3), which are mounted on a magnetic support (5), one of the mirrors is fixed and the second (4) performs a movement in the direction of measurement, in this case on Z direction of the machine. With the help of spirit leveling device (2) we can check the horizontality for the laser and mirrors.

The linear measurement on Z axis at the Flexible Manufacturing Cells UO-01 FMC realized by XL 80 laser with interferometer is according to international standard ISO 230-2, [20], .



Figure 2.2.8. The linear measurement on Z Axis at the Flexible Manufacturing Cells UO-01 FMC realized by XL 80 laser [20]

After the measurements the software generate the graphic, which is presented in the figure 2.2.9 [20].

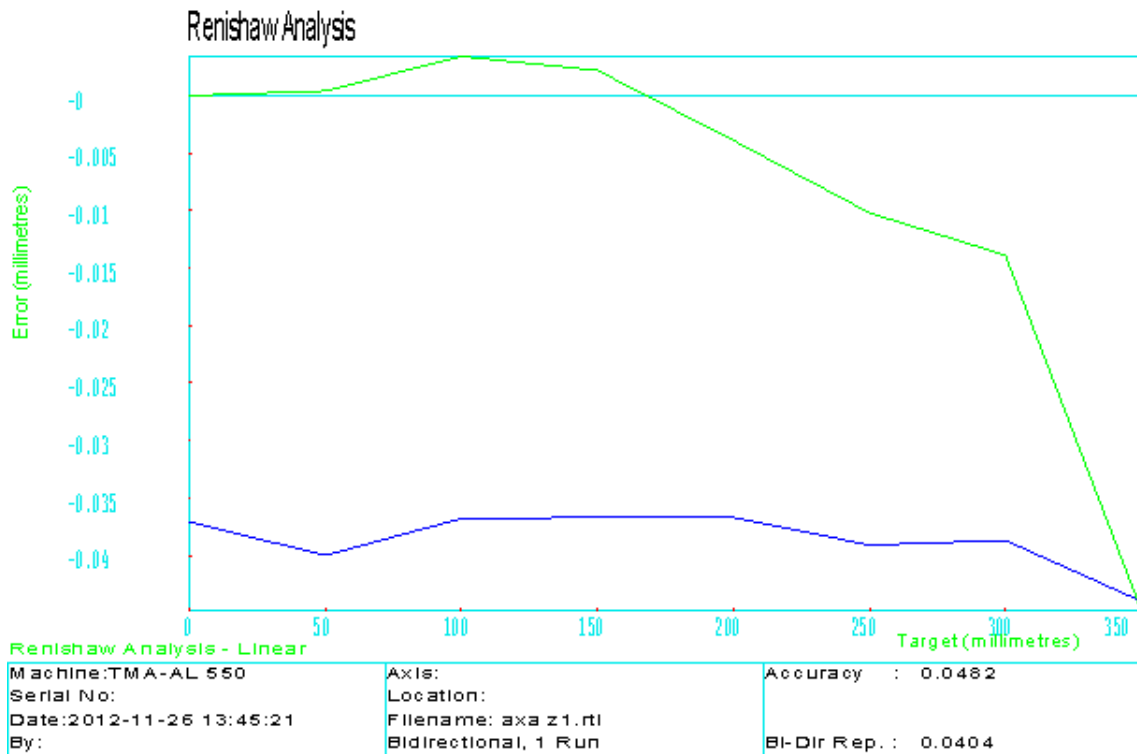

Figure 2.2.9. View of graphic positioning errors realized by Renishaw Analysis on Z axis at the Flexible Manufacturing Cells UO-01 FMC (TMA –AL 550) [20]

As it results of the measurements realized by laser XL 80, the positioning errors can be observed on the data table, presented in the figure 2.2.10 [20].

```

RENISHAW CALIBRATION INTERFEROMETER SYSTEM
CAPTURED DATA TABLE

Machine:TMA-AL 550          Serial No:
Date:2012-11-26 13:45:21   By:
Axis:                       Location:
TITLE:                      Filename: axa z1.rtl
    
```

Run	Dir	Target	Target value mm	Actual reading mm	Error mm
1	(+)	1	0.0000	-0.0371	-0.0371
1	(+)	2	50.0000	49.9600	-0.0400
1	(+)	3	100.0000	99.9632	-0.0368
1	(+)	4	150.0000	149.9633	-0.0367
1	(+)	5	200.0000	199.9633	-0.0367
1	(+)	6	250.0000	249.9609	-0.0391
1	(+)	7	300.0000	299.9613	-0.0387
1	(+)	8	350.0000	349.9560	-0.0440
2	(-)	8	350.0000	349.9552	-0.0448
2	(-)	7	300.0000	299.9861	-0.0139
2	(-)	6	250.0000	249.9898	-0.0102
2	(-)	5	200.0000	199.9961	-0.0039
2	(-)	4	150.0000	150.0022	0.0022
2	(-)	3	100.0000	100.0034	0.0034
2	(-)	2	50.0000	50.0004	0.0004
2	(-)	1	0.0000	0.0000	0.0000

Figure 2.2.10. View of table data for the measured positioning errors for UO-01 FMC (TMA –AL 550) [20]

With the laser XL 80 software we have the possibilities to view the error compensation table presented in figure 2.2.11, which is transmitted through the stick to CNC of machine UO-01 FMC (TMA-AL 550) [20].

RENISHAW CALIBRATION INTERFEROMETER SYSTEM ERROR COMPENSATION TABLE			
Machine:TMA-AL 550		Serial No:	
Date:2012-11-26 13:45:21		By:	
Axis:		Location:	
TITLE:		Filename: axa z1.rtl	
Table type		Separate forward and reverse tables	
Compensation type		Incremental	
Compensation resolution		0.001 mm	
Sign convention		As errors	
Reference position		0.0000 mm	
Compensation start		0.0000 mm	
Compensation end		350.0000 mm	
Compensation spacing		50.0000 mm	
Compensation values			
No.	Axis position (mm)	Forward direction (0.001 mm)	Reverse direction (0.001 mm)
1	0.0000	0	37
2	50.0000	-3	0
3	100.0000	3	3
4	150.0000	0	-1
5	200.0000	0	-6
6	250.0000	-2	-6
7	300.0000	0	-4
8	350.0000	-5	-31

Figure 2.2.11. View of error compensation table for UO-01 FMC (TMA –AL 550) [20]

With the help of laser software, we have the possibility to choose from analysis menu a report according to international standards ISO, ASME, VDI, JIS and achieving the compensation errors, which are transmitted to the CNC machine [20].

2.2.2. Precision evaluation of the CNC machining center in dinamic conditions

The progress of a company is given by the shortest possible product development and market output. In this context, digital manufacturing technologies have been on continuing development, an important role within them having working on CNC machine tools [33].

As is known, the pieces can not be processed at nominal dimensions, each piece having the own tolerances mentioned on the production drawing [33].

The main factors which influence the processing accuracy are [33], [68]:

- thermal deformations of the technological system (machine tool, device, tool part)
- elastic deformations of the technological system elements under the action of forces which are generated in the cutting process (machine tool, device, tool part);
- vibrations caused by various elements from the environment or vibrations due to the manufacturing process;
- runtime errors of the elements which form the technological system (machine-tool, device, tool part);
- wear of the elements which form the technological system (machine tool, device, tool part).

If you assume that measures are taken to prevent and reduce the errors caused by elastic and thermal deformations, and also vibrations regarding the tool and fixture device, it can be said that the precision of the machine tool directly influences the quality of parts, which it processes both from the point of dimensional errors view and in terms of surface quality (roughness) [33].

This accuracy is given by the accuracy of execution the component elements and by the precision of relative motion between them [33].

The machine tool precision is influenced by several factors. Accuracy depends on the errors of the execution of components, their wear, their fixation on the ground (foundation) and the ambient temperature, that is continuously changing [33].

Geometric errors are repeatable and have always have the same values during processing of different parts [33], [107].

In order to test the accuracy of the machine tool must be achieved a system that provides information regarding the precision movement of the component slides and spindle [33], [66].

A precision machine tool assumes maintaining the capacity to produce parts according to the requirements of their drawings documentation [33].

If accuracy is low, this implies additional costs to remedy defects, or, in some cases, it becomes necessary to rework the piece. It is therefore necessary that the machine to be properly maintained as long as possible [33], [67].

To verify the accuracy of machine tools it was used the QC20 W ballbar system from Renishaw Company (figure 2.2.12), [33].

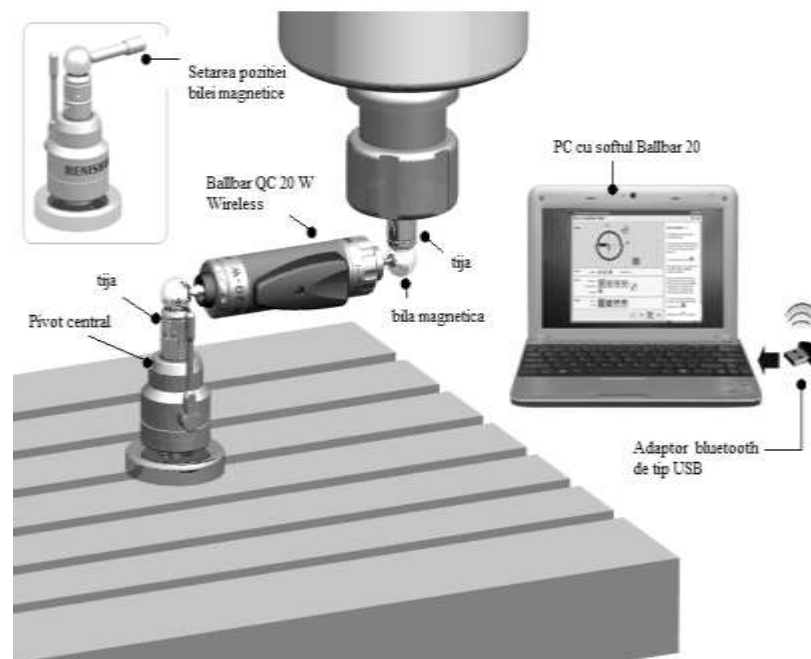

Figure 2.2.12. The QC 20 W ballbar system [33], [128]

The device consists of two very precise magnetic spheres made of steel connected together with a telescopic bar [33].

The measurement of errors is achieved by varying the distance between the two balls with a transducer mounted in telescopic bar [33].

The device is used to verify the interpolations errors on a circularly trajectory [33].

The Ballbar QC2-W system with its software is used to verify the geometric errors at CNC machine tools in order to detect the deviations that are introduced by CNC and driving systems [33], .

The standard kit contains a high precision linear transducer, a device Zerodur for calibrating and a central pivot that permits performing tests on a 220° arc [33].

The transducer emits electric signals which are processed and transmitted by wireless to a computer [33].

The errors are measured by the achievement of a circle or an arc of the circle by the machine tool and then the measured values are compared with the values imposed by documentation [33].

The deviation analysis is needed to highlight the machine imperfections which can be static and dynamic [33].

After the diagnosis was performed, they can be modified some parameters of the machine tool in order to increase its moving precision [33].

The Ballbar system QC 20 W has the capability to check the performance of CNC machining centers by verifying the circularity, perpendicularity, backlash, correlation the moving speed between the axes [33].

There are also the possibilities to check the absolute radius of the tool trajectory and to determine the deviations according to ISO 230-4 [33].

The results are analysed and there have been issued the reports which can be used to make corrections on the machine tool [33].

The ballbar system is used by the manufacturers and users and it has the possibility to identify 19 kinds of errors of machine tool [33].

The system allows the testing in XY YZ and ZX planes in a single configuration and testing at 220° in two planes (figure 2.2.13), [33] and also volume measurements.

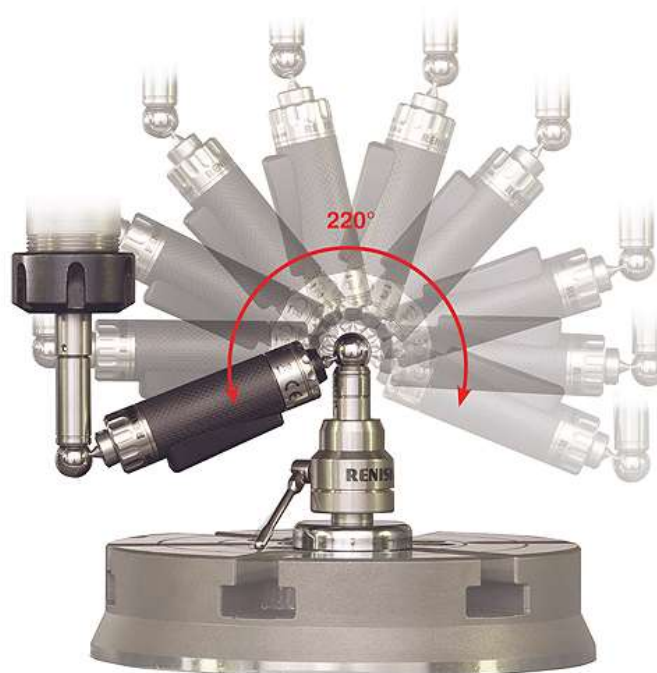

Figure 2.2.13 Testing at 220° in two planes [33], [128]

To achieve the measurements with the Ballbar, is needed in the first step to calibrate the system, and then to indicate the kind of machining center [33].

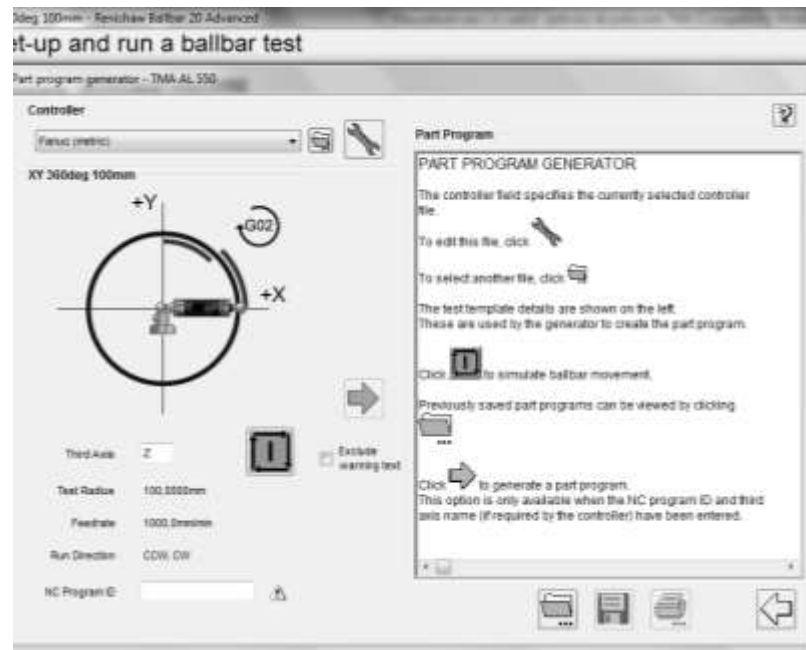

Figure 2.2.14 Specification the input data [33]

To perform the measurement program they must specify the CNC controller of the machine tool then the feed, the sense of rotation (figure 2.2.14) [33].

In our case the controller is Fanuc 30i, the feed is 1000 mm/min and the sense of rotation is clockwise in the first time and counter clockwise at the second time [33].

After performing all the needed steps it is obtained the CNC program for measurement in XY planes for UO-01 FMC machining center [33].

The obtained program is saved on CNC machining center and then is verified the path by a moving with no loads in order to prevent the collisions which can appear [33].

After the all measurements were done, the software of the Ballbar system generates an errors graph presented in figure 2.2.15 [33].



Figure 2.2.15 The central pivot mounted on the Tombstone device [33]

To achieve the measurements on UO-01 FMC machining center it was used a modular device Tombstone, which has been mounted the central pivot on (figure 2.2.16) [33].

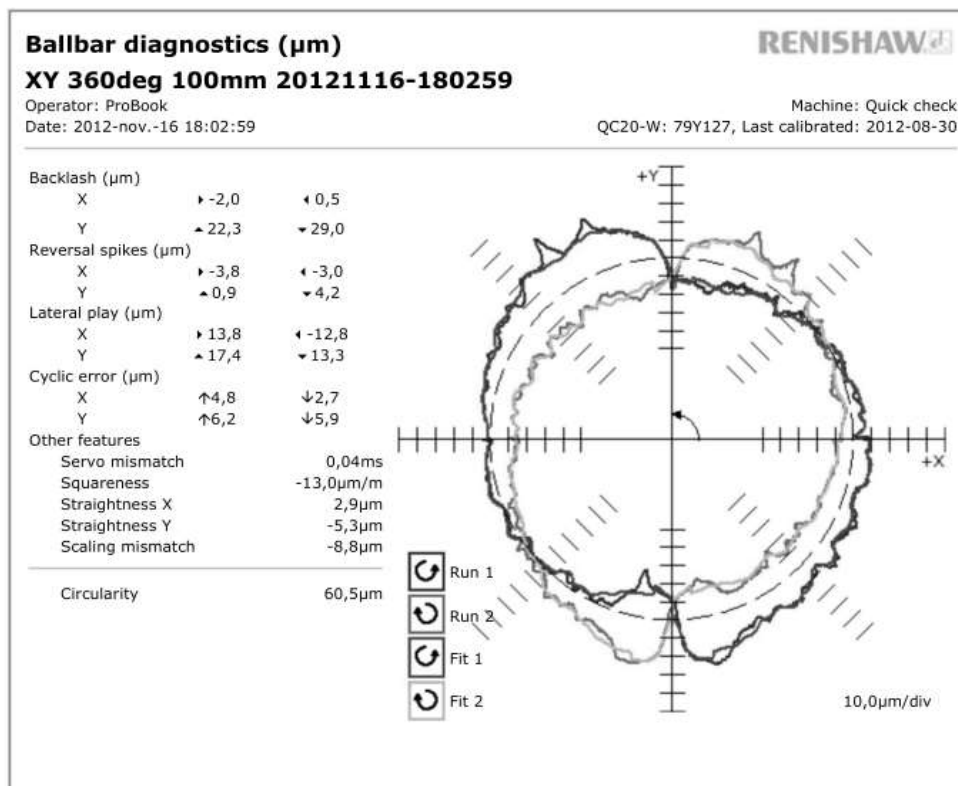
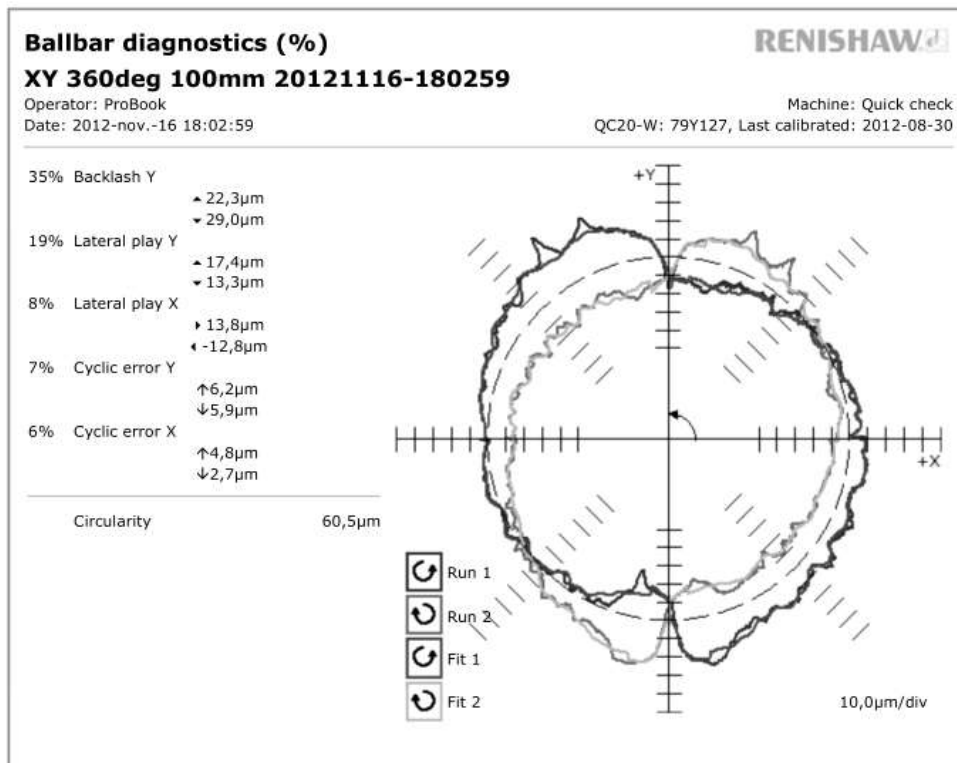

```

O11 (NC program ID)
Quick check: XY 360deg 100mm)
(XY, 360 degree test, 100 mm radius, 1000 mm/min feedrate)
(Work offset must be defined where the centre mount is positioned)
N10 G71 (input in mm)
N20 G54 (set origin position)
N30 G90 (absolute dimensions)
N40 G17 (XY plane)
N50 G64 (disable stopping between moves)
N60 M05 (extra header code)
N70 M19 (extra header code)
N80 G94 F1000 (feedrate in mm/min)
N90 G01 X103.500 Y0.000 Z0.000 (move to start point)
N100 M00 (stop to load ballbar)
N110 G01 X100.000 Y0.000 (in feed)
N120 G03 X100.000 Y0.000 I-100.000 J0.000 (CCW arc)
N130 G03 X0.000 Y100.000 I-100.000 J0.000 (CCW arc)
N140 G01 X0.000 Y103.500 (out feed)
N150 G04 X5 (pause between runs)
N160 G01 X0.000 Y100.000 (in feed)
N170 G02 X0.000 Y100.000 I0.000 J-100.000 (CW arc)
N180 G02 X100.000 Y0.000 I0.000 J-100.000 (CW arc)
N190 G01 X103.500 Y0.000 (out feed)
N200 M30 (end of program)
. %

```

Figure 2.2.16 The errors graph [33]

The diagnose of machine tools is needed in order to assure a higher reliability of the maintenance cycle and to avoid scraps, the result being an increase in work productivity [33].

Due to multiple influence factors, determination of the accuracy of machine tool implies a laborious work, special devices and computer software [33].

The quality of each manufactured part is dependent on the machine tool accuracy [33].

In this research was presented a modern method to check the accuracy of the motions of circular interpolation, by using the Ballbar system QC 20 W from RENISHAW [33], .

To conclude the research, there were interpreted the results and identified that cause of errors comes from hydraulic system. For the time being, it has been working on regulation of this system [33].

By analysing the errors graph was concluded that the problems are caused by the hydraulic equipment which were acting on the ball screw. Currently, this cause is being processed [33].

2.2.3. Thermographic diagnosis at machine tools

The thermography is science who is occupied with acquisition and analyze of thermal information obtain with infrared scanning equipment without contact [92].

The thermal cameras convert the infrared image in visible image for eyes [92].

Thermal Camera FLIR SC 640 [92] is a portable thermographic for scan, without cooling with the most powerful existing IR detector who had a resolution of 640x480 pixeli which shows

thermal sensitivity found only in cameras with cooling where the temperature are minimal 0.04 ° C, [92], [130].

The thermographic camera FLIR SC 640 dispose of new functions to overlay the thermal image into visible image (Picture-in-Picture) and have possibility to combine the thermal image with visible image (Thermal Fusion). [131], [133], [134].

In figure 2.2.17 is represented the component elements of Flir SC 640 thermal camera who is equipped with a laser pointer, germanium lens, SD card, USB and Video connector [92].

The thermographic views of the objects are realized in 2 modes: through a tilt-able viewfinder and through a large color LCD [92].

Scanning with Thermo camera FlirSc 640 presents advantages as follows [92]:

Allows scanning objects at a distance without contact, the testing is non-destructive against measured objects, provide predictive maintenance for equipments and defects in the early stages to reduce costs [92].



Figure 2.2.17. The component elements for Thermal Camera Flir SC 640 [92],

The main domains using of the thermal camera Flir SC 640 are follows [92]:

- In research and development the thermal camera Flir SC 640 is destined domain due the picture quality and the possibility of filming at 640x480 resolution;
- Manufacturing for prevention of defects via monitoring and inspection of the equipment;
- Electromechanics to verification of the overheating bearing for electric motors, checking operation in the thermals parameters at the bearings, axes, transmissions;
- Manufacturing industry for monitoring the cooling installations function at the machine tools, monitoring the machining process (milling, drilling, boring, etc.);
- Predictive maintenance for equipment in electrical field, buildings, mechanics, ovens and boilers, etc. [90], [108].

Case study regarding the thermography diagnosis at the Universal milling machine FUS 32

The present research shows the new and modern method to identify of the possible future damages at the automatic technological installations caused by the influence of the heating. As sample for advanced the research shows the thermographic diagnosis at universal milling machines FUS 32 which was analyzed at the stage of putting in function using the thermal camera Flir SC 640 for capture the image in infrared and the Flir Reporter 9.1 software for analyze, who was purchased by University of Oradea through project Intelbuild HURO 0802/155. [133], where the undersigned was the general manager of project.

In the figure 2.2.18 is presented the universal milling machines type FUS 32 manufactured by Stimin factory. This machine has two main spindles: Vertical (figure 2.2.18) and also horizontal milling spindle into the machine ram. [54], [135].



Figure 2.2.18. The universal milling machines FUS 32 in visible [54], [135]

In figure 2.2.19 is presented the infrared image realized with thermal camera Flir SC 640, and processed by Flir Reporter 9.1 software which is used to create reports in infrared based on pictures [92].

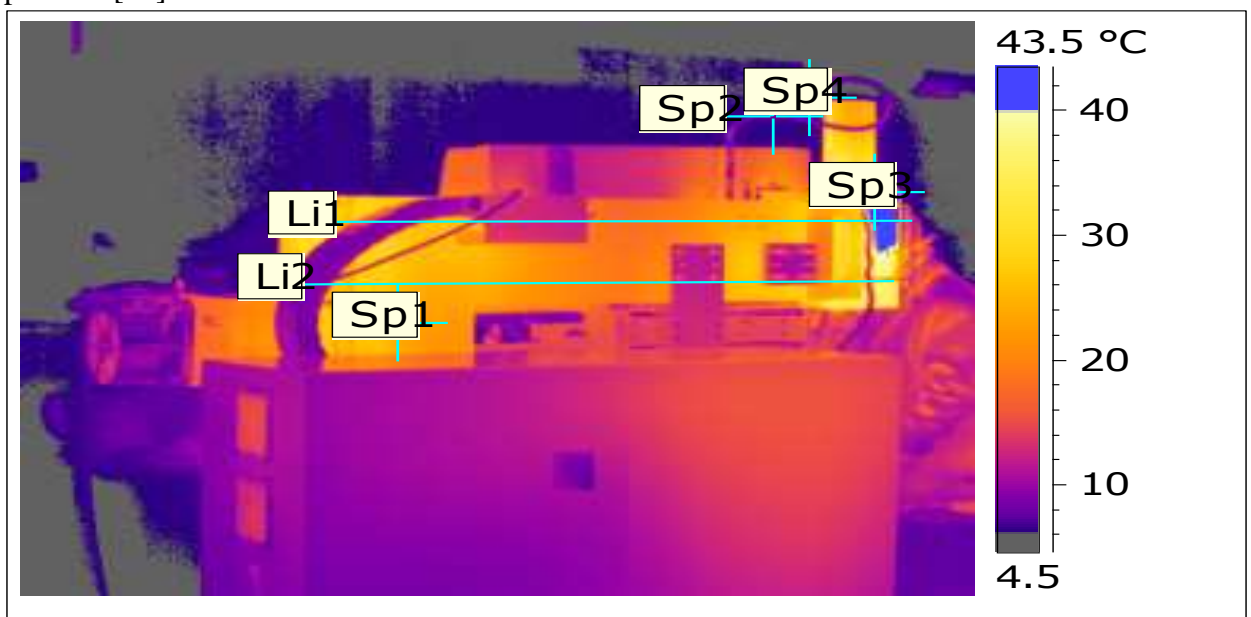

Figure 2.2.19 The universal milling machines FUS 32 on infrared [92]

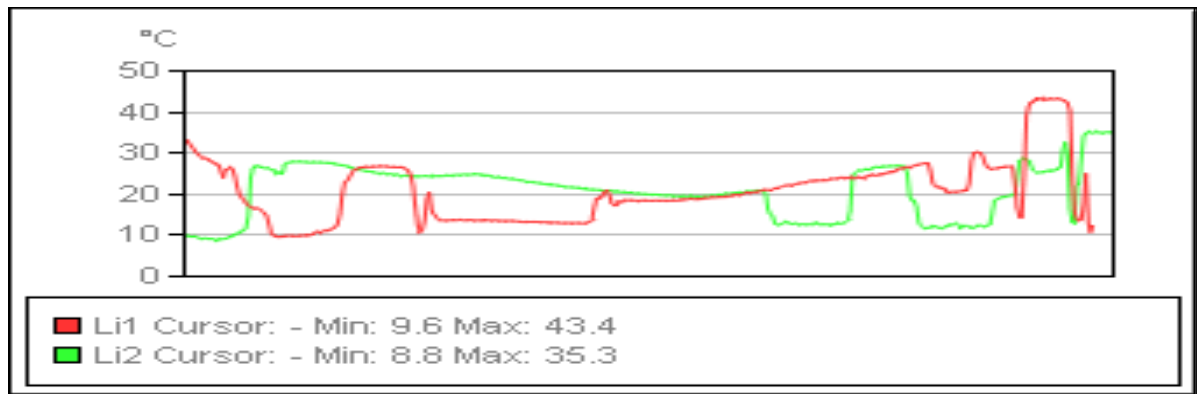

Figure 2.2.20. The variation of temperature emitted by universal milling machines along the lines Li1 and Li2 [92]

The temperature of point sp2 is 9.6 degrees and in the point Sp4 is 27.2 degrees who indicate a deflection of connection at the lubrication cable [92].

In figure 2.2.20 [92] is represented the variation of temperature emitted by the horizontal milling machines along the lines Li1 and Li2.

In the realized report using the isotherm represented with the colour blue we observed the temperature exceeds maximum limit of 40 degrees, and the isotherm represented with grey colour present the minimal temperature below 4.5 degrees [92].

We observed in figure 2.2.20 the temperature in spot Sp 3 is 48.5 degree who represents the main spindle high temperature [92].

In figure 2.2.21 [92] is represented the main spindle at the universal milling machines FUS 32.

In figure 2.2.22 [92] is represented the infrared picture with main spindle at the universal milling machine FUS 32 and with Li1 is represented the contour of spindle when it rotate in goal at 2000 rot/min.



Figure 2.2.21 Main spindle at universal milling machines Fus 32 in visible [92], [135]

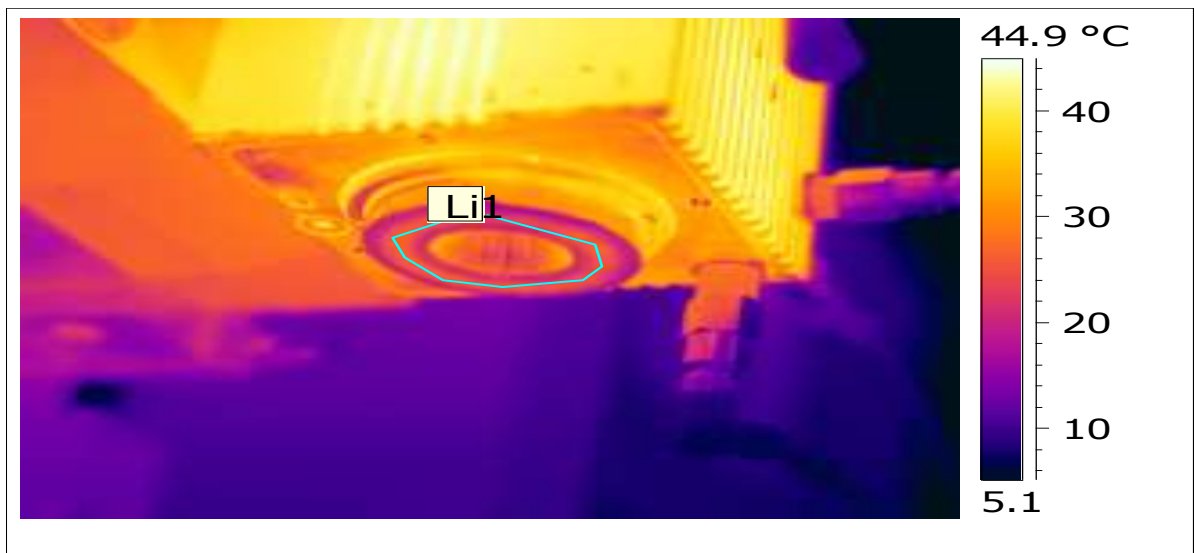

Figure 2.2.22 Main spindle at universal milling machines FUS 32 in infrared at the 2000 rot/min [92]

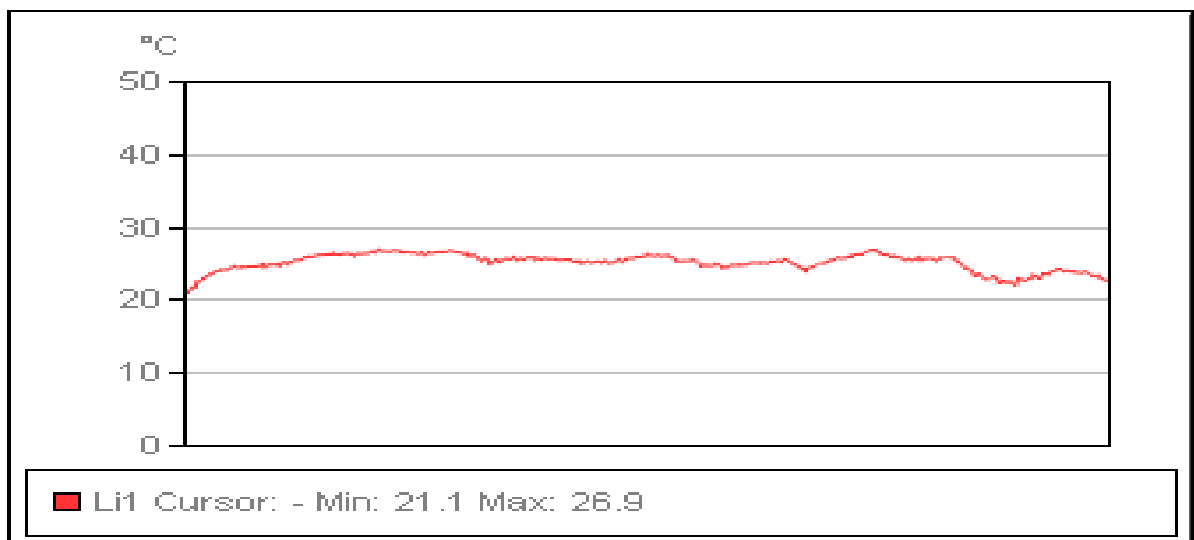

Figure 2.2.23. The variation of temperature at the vertical main spindle along the line Li2 at the 2000 rot/min [92]

The figure 2.2.23 [92] present evolution of temperature at the vertical main spindle when is rotate by 2000 rot/min.

The interval of temperature is below 20- 30 degrees, we observe at the beginning the minimal temperature is 21.1 degree and grows to maxim 26.9 degree [92].

In figure 2.2.24 is represent the infrared picture with vertical main spindle at the horizontal milling machine FUS 32 and with Li2 is represent the contour of spindle when it rotate in goal at 3000 rot/min [92].

The figure 2.2.25 present evolution of temperature at the vertical main spindle when is rotate by 3000 rot/min [92].

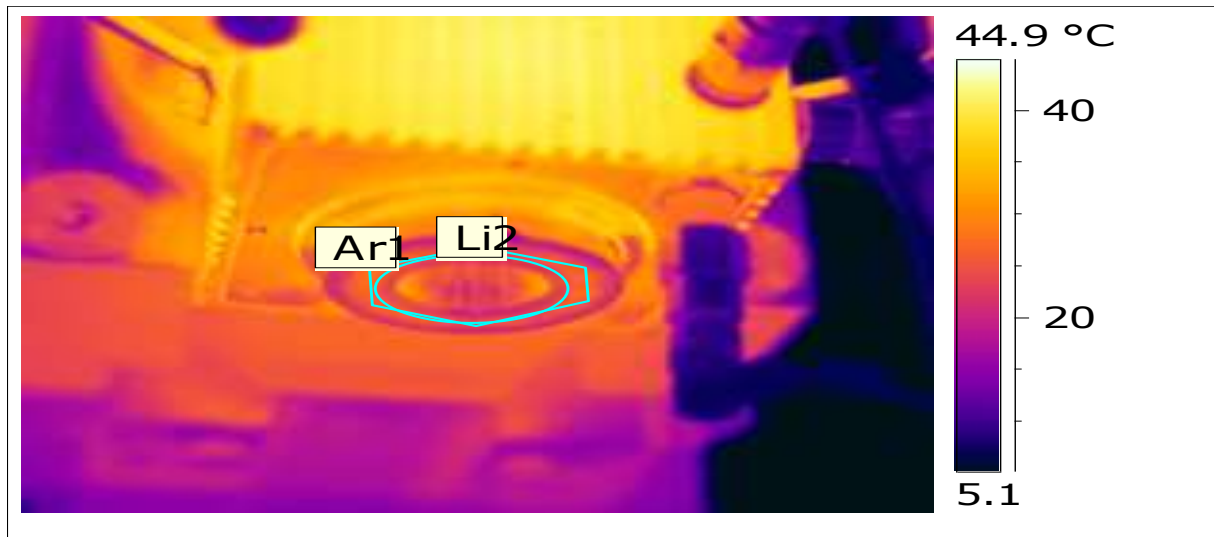

Figure 2.2.24 Vertical main spindle at universal milling machines FUS 32 in infrared at the 3000 rot/min [92]

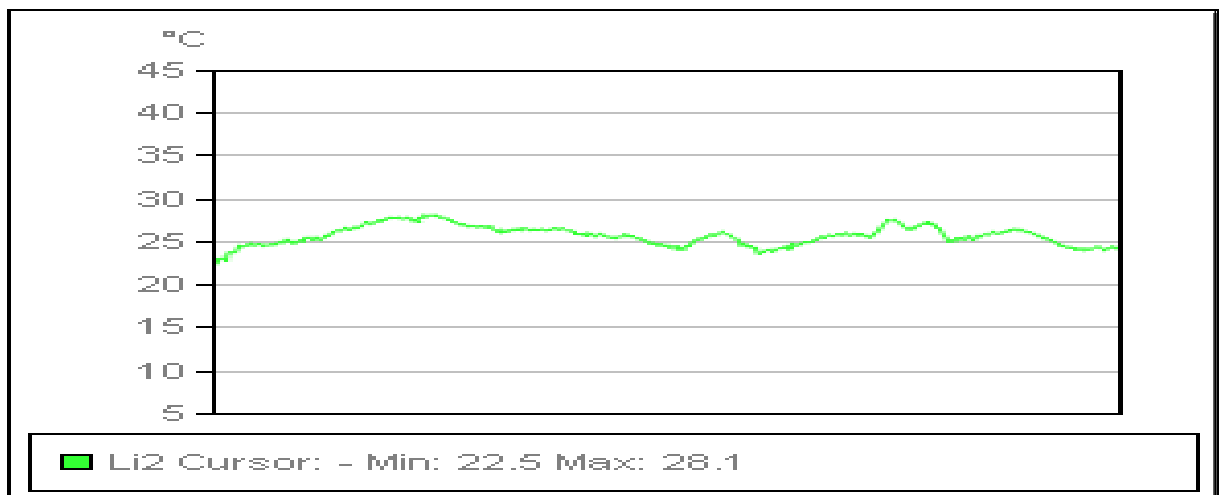

Figure 2.2.25 The variation of temperature at the vertical main spindle along the line Li2 at the 3000 rot/min [92]

The interval of temperature is below 20-30 degrees, we observe at the beginning the minimal temperature is 22.5 degree and grows at maxim 28.1 degree [92].

The termographic diagnosis is a new method able to identify the possible sources of heating which can evolve in time up to dangerous stage [92].

The cause of heating can be [92]: the missing of the cooling of spindle or gear box bearings, the preload of the bearing at to high value, mechanical errors in the spindle assembly or in the gear box producing mechanical friction, lubrication oil without thermal compensation, etc.

These sources of heating can increase the temperature of moving parts (especially the bearings) up to dangerous value producing the burning of grease and the blocking of the bearing. These is classical and the most dangerous case of failure caused by the heating [92].

Now the new method help at the identification of these heating source at the stage of the machine putting in function, it is necessary one better identification associated with vibration/ noises, power consumption of free load regime, all these contribute at the possible future failure. After the identification is compulsory necessary to improve the machine construction or the heating compensation installation in order to obtain one stable regime with constant temperature in the acceptable limits [92].

The method applied at the machine FUS 32 is a sample for non-destructive analyzes, quick and precise with good results [92].

2.3. Research in the rotary-tilting table (RTT) field [35]

The 5-axes milling machines have a large application field due to their possibilities to work complex surfaces with high accuracy and repeatability. The five axes can be found in various combinations of the worked piece and the tool. The 5-axes milling machines can be categorised by two criteria [7]:

- a) the number of axes associated to the worked piece or tool, as well as the succession of each axis in the cinematic chain, the places of the rotation axes in the work space or on the tool side; by this criterion, one can find 5-axes milling machines with two rotation axes associated to the tool, one rotation axis associated to the tool and one associated to the worked piece, and with two axes associated to the worked piece.
- b) the places of the rotation axes in the work space or on the tool side. Anyway, one principle is applied: the rotation axes are placed to the worked piece in the case of machines that work small pieces, and the rotation axes are placed to the tool in the case of big and heavy worked pieces. From the constructive point of view, there are machine tools with the rotation axes embedded in the machine structure, and 5-axes machines fitted with rotating and tilting tables or with detachable work heads with two rotation axes [7].

Among the machine producers, Ghildemeister has created a new series of machines with high accuracy working and high speed type HSC (High Speed Cutting), with simultaneous three or five axes. Each axis features accelerations greater than 2g and rotation speeds up to 42000 rpm. The surface quality is $R_a < 0.2 \mu\text{m}$ and the positioning accuracy is less than 5 μm [35], .

Also, the 5-axes high precision milling machines HURON K2X five allow simultaneously working in five axes of: active parts of the injection dies, aeronautic parts or precision engineering components. The association of dynamics and precision allows the attainment of high quality surfaces [35], .

As for the rotating and tilting independent tables, these are present on the market in a wide range. Thus, series TRNC of rotating and tilting tables are presented in , with the following features: plateau diameter 255+400 mm; maximum rotation speed 11.5+25 rpm; tilting angle 0-100°. Series CTL is presented in , with the following features: plateau diameter 165-254 mm; maximum rotation speed 10+20 rpm; tilting angle -5+ 100° [35].

The rotating advance of these tables must ensure the elimination of the return clearance, elimination of the vibrations during working, accurate positioning and high repeatability, and an advance speed of at least 20 rot/min. These problems must be solved taking into account the conditions of a required minimum size [35].

2.3.1. The constructive design of the RTT [34]

Another part of the research aimed to design the constructive rotary-tilting tables. The objective was the development / realization a family of rotary-tilting tables, used at transforming 3-axis CNC machining centers into 5-axis CNC machining centers [34].

The rotary feed of these tables must assure the elimination of rotary backlash, elimination of vibrations during processing, high positioning accuracy and high repeatability. In addition, an advance speed of at least 20 RPM [34], [121], [123].

Solving these problems in terms of a minimum required size is a problem that needs to be solved [34].

The solutions adopted for the advance mechanisms of the rotary-tilting tables are based on two main types [34]:

- feed mechanisms with gears, provided with various solutions to remove the backlash;
- torque, or built-in motor mechanisms, which do not have gears, the motor casing being in the frame of the rotary table.

Choosing a solution for the rotary feed mechanism was made taking into account both functionality and the associated costs. The Direct Drive solution with built-in motors, which although are recommended for these applications due to its functionality and reliability, was abandoned because of the high cost [138], [139], [140], [141].

Ensuring a high operating accuracy even under a considerably lower reliability, but with lower cost lead to equipping the rotary-tilting table family with duplex worm gears feed mechanisms [61], [36], [136], [137].

The kinematic schematic diagram of the rotary-tilting table is presented in Figure 2.3.1, [34].

To ensure a balanced load of the rotary feed mechanisms, two synchronously operated worm gears were used [34].

During the rotation of the table, due to the use of a gear provided with a worm wheel and two diametrically opposite wheels, to ensure the movement, the wheels will rotate in the opposite direction [34].

This can be done using a gear with spur gears and a transmission with a toothed belt, as in Figure 2.3.2, [34].

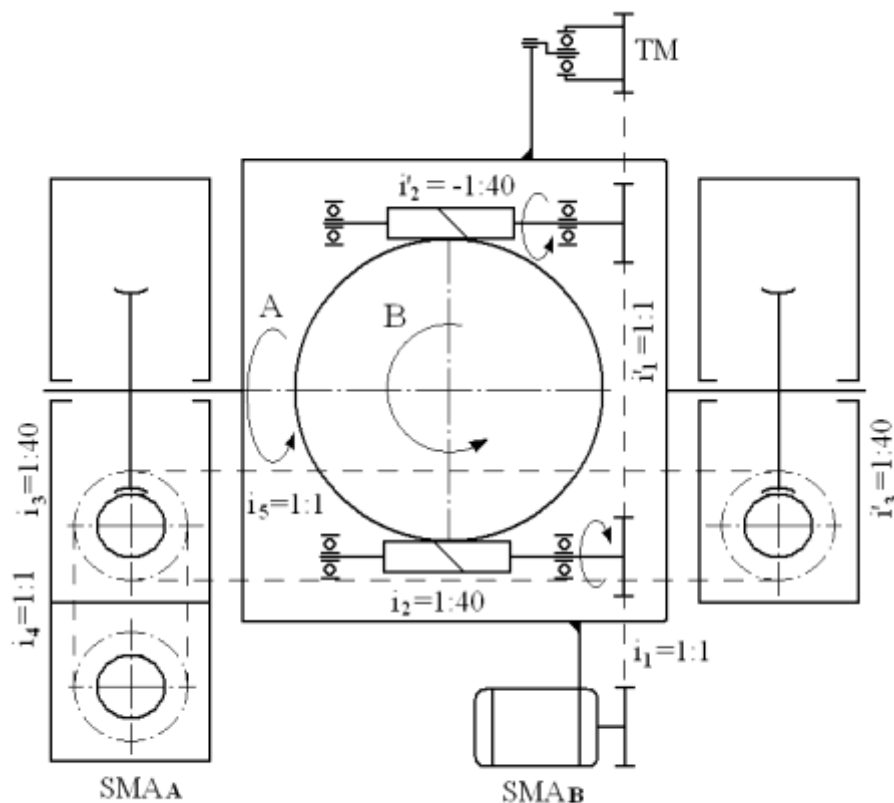

Figure 2.3.1. Kinematic schematic diagram of the rotary-tilting table family RTT-5 [34]

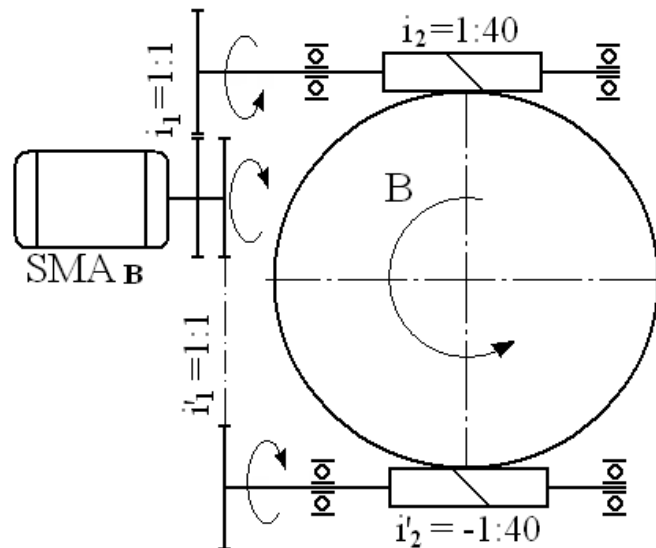

Figure 2.3.2. The kinematic schematic diagram for the spur gears and the toothed transmission belt [34]

Removing the backlash when changing the direction in the case of the spur gears is difficult and expensive. For this reason, the solution of driving the two worm gears with a single toothed belt was chosen [143], as shown in Fig.2.2.26. For this purpose, a synchronous twin toothed belt was used, manufactured by the Gates company, (Figure 2.3.3), [34].



Figure 2.3.3. TWIN POWER BELT – synchronous toothed belt [34], [143]

The rotary-tilting table with 250 mm table diameter has the goal of equipping the 5-axis machining centers with the possibility of processing sculptural profiles. For this purpose, a rotary-tilting table with the following characteristics was realized [34]:

- Table diameter 250 (mm);
- Maximum shelf rotation speed 75 (rot/min);
- Maximum torque at the worm gear 420 (Nm);
- Positive tilt angle 135°;
- Negative tilt angle 10°.

In order to increase the tilt angle in the conditions of low height of the table [34], a solution with an SMS_B servomotor was adopted, placed coaxially with the tilt axis B, as shown in Figure 2.3.4.

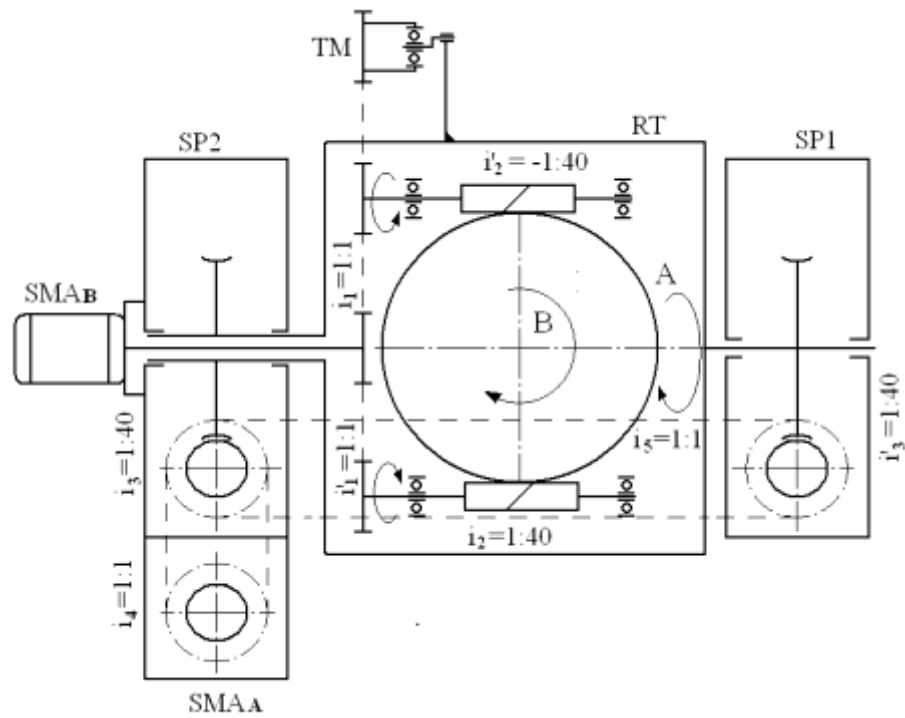

Figure 2.3.4. Kinematic schematic diagram of the rotary-tilting table RTT-5 with 250 mm shelf diameter [34]

The design of the rotary-tilting table is presented in Figure 2.3.5, where the positioning of the tilting servomotor SMA_A and the rotary servomotor SMA_B can be observed [34].

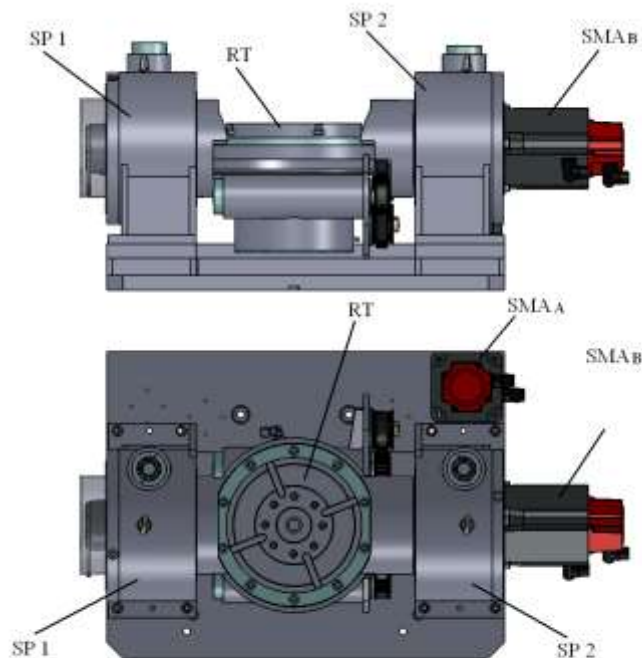

Figure 2.3.5. Rotary-tilting table RTT-5 with 250 mm shelf diameter [34], [143]

As shown, the SMA_A servomotor is placed on the base plate [34].

The circular tilting movement is taken from the SMA_A servomotor through a synchronous belt, and transmitted to the duplex worm gears, positioned on both sides of the

table shelf, and has the role of tilting the RT rotary table around the SP1 and SP2 swivels. The SMA_B servomotor, placed coaxially with the B rotation axis, generates a continuous rotary movement of the RT table [34].

From the servomotors, to the worm gears, the movement is transmitted through synchronous toothed belts with a gear ratio of $i=1:1$

Thus [34]:

$$i_4=i_5=1:1$$

The circular rotary movement of the shelf is taken from the servomotor SMA_B through a synchronous TWIN belt, and transmitted to the duplex worm gears. The gear ratio of the synchronous TWIN toothed belt transmission is also $i=1:1$

Thus [34]:

$$i_1=i'_1=1:1$$

Duplex worm gears by STIMIN company were chosen, having the following characteristics [34]:

Table 2.3.1. Characteristics of duplex worm gears by STIMIN company [34]

WORM GEAR	Size	40	WORM WHEEL	40
	Distance between axes	104		104
	Gear ratio	1:40		1:40
	Direction	Right		Right
	Pitch diameter	48		160
	Number of teeth	1		40
	Diametral coefficient	12		12
	Module	4		4
	Large step of worm screw	12,816		12,816
	Small step of the worm screw	12,315		12,315

Gear ratio [34] of the spur:

$$i_2=-i'_2=i_3=-i'_3=1:40$$

the maximum speed of the servomotors is calculated [34]:

$$i_2=n_p/n_{max} \tag{2.3.1}$$

$$n_{max}=i_2 \cdot n_p \tag{2.3.2}$$

n_p -the rotary speed of the shelf [rot/min]

n_{max} -maximum speed of the servomotor [rot/min]

$$n_{max}=40 \cdot 75=3000$$

For the drive, the following servomotors were chosen: Ais12/3000 A06B-0078-B203 manufactured by the firm Fanuc (Figure 2.3.6), with the following characteristics [142], [34]:

- nominal power.....2,8 (kW)

- torque.....12 (Nm)
- maximum speed.....3000 (rot/min).

Verifying the motor torque is done with the relation

$$T_{\max} = i_2 T_{m_{\max}} \tag{2.3.3}$$

T_{\max} - maximum torque at the rotary table, given by the motor

$T_{m_{\max}}$ - maximum torque of the driving servomotor SMA

$$T_{\max} = 40 \cdot 12 = 480 \text{ (Nm)}$$

The SMA servomotors ensure a torque that covers the maximum required at the rotary-tilting table (400Nm), [34], [143].



Figure 2.3.6. Servomotor Ais12/3000 A06B-0078-B203 [34], [143]

In the kinematic schematic diagram in Figure 2.3.7 [34] the path of the belt required to ensure the opposite direction rotation of the two worm gears is presented.

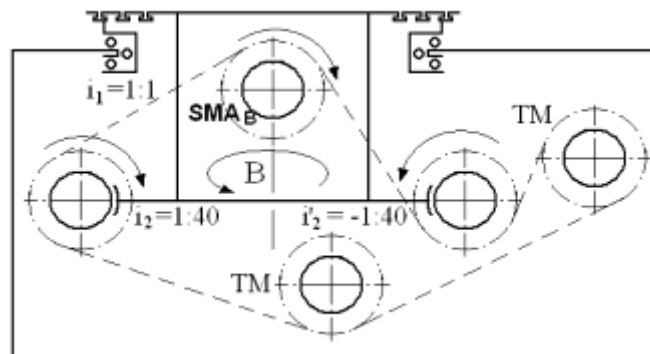

Figure 2.3.7. Kinematic drive schematics of the worm gears at table rotation [34]

The design for the synchronous toothed belt transmission at axis A is shown in Figure 2.3.8 and for axis B in [34] Figure 2.3.9.

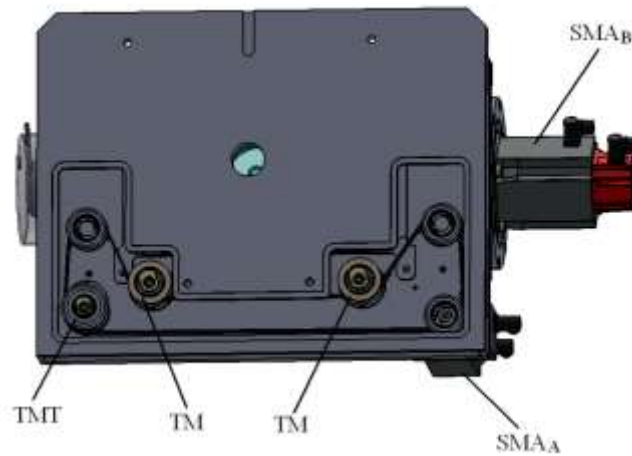

Figure 2.3.8. The synchronous transmission solution at the tilting axis [34], [143]

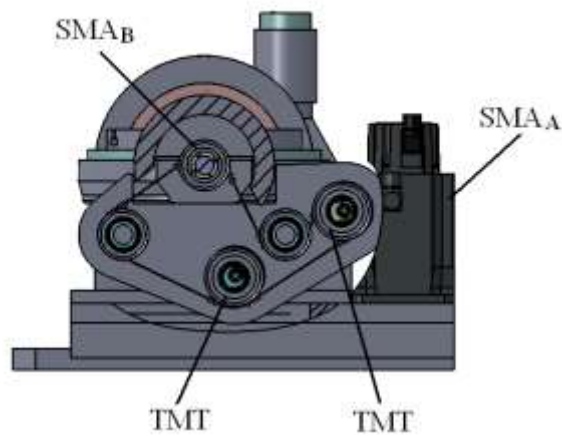

Figure 2.3.9. The synchronous transmission solution at the continuous rotation axis [34], [143]

The TIM and TMT tensioners are excentric tensioners, used both to draw the path of the toothed belt, and to stretch the belt to the value set by the manufacturer [34].

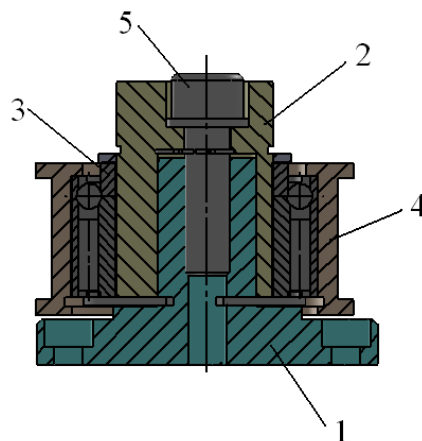

Figure 2.3.10. Eccentric tensioner [34], [143]

This version was chosen because it has a small size and is stiff. They are made of body 1, eccentric 2, which is rotated by roller 4 hold in position with the axial bearing [34]. Blocking is done with screw 5. Two types of rollers are used, as shown in Figure 2.3.11 [34].

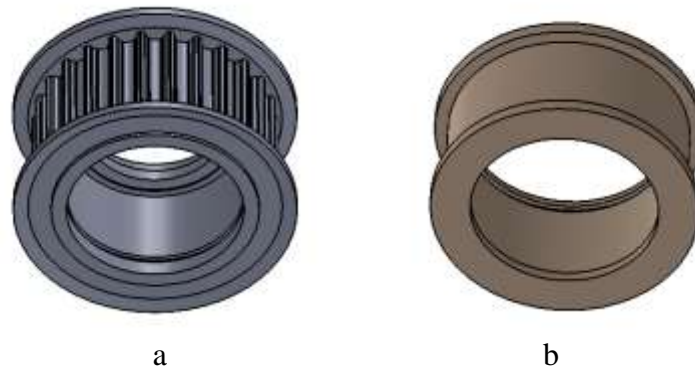

Figure 2.3.11. Tensioner rolls [34], [143]

TMT tensioner will be used, when the contact of the roller with the belt is on the teeth, the roller used will be toothed (Figure 2.3.11 a), respectively TM tensioner is used if the the roll is in contact with the smooth side of the belt, the tensioner being equipped with smooth roller [34].

Drive solution applied to the rotary-tilting table with 250 mm table diameter is suitable for equipping 5-axis CNC machining centers, having a high advance speed, and elimination of eversing backlash. A large tilt angle is achieved, so the range of applications of the rotary table may also satisfy the processing of sculptural surfaces [34].

Reduction of costs were taken into account, without diminishing the performance of the table [34].

2.3.2. The ensure of precision work for RTT [27]

This research proposes the description of an evaluation method of the precision of a rotary – tilting table which is a component of a 5 axis machining center. It starts from the mathematical modeling, numeric simulation and 3D simulation [27].

At the end the procedure is implemented on the machining center, the measurements are made, errors are discovered and the causes of errors are finally eliminated [27].

Evaluation of precision of simultaneous 5 axis machining centers is a complex problem which presumes the development of new procedures based on mathematic relations defining correlations of two rotation axis [27].

The undertaken studies in the field proposes a method of evaluation of geometric precision of a rotary – tilting table using the ballbar system. Development of the method is made by establishing the correlation between the two rotations (by the axis B and C). In order to check the correctness of the method a numeric simulation model, 3D measurement system and also experimental measurements had been made [27].

Using the proposed method the geometric errors of the rotary – tilting table had been corrected [27].

Dimensional precision of manufactured parts is influenced by a series of factors as: elastic and thermal deformations of the technological system, mechanical vibrations, wear of the technological system elements, manufacturing errors [27].

If we suppose that measures had been taken to eliminate vibrations, elastic and thermal deformations and manufacturing errors of the machine tool, it can be said that the precision of the devices directly impacts the surface quality and the dimensional precision of the manufactured part [27].

There is a small coverage of 5 axis machining in general and of manufacturing precision in particular in the reference literature [27].

The NAS 979 [144] American standard describes manufacturing tests for conventional and NC machine tool evaluation excepting drilling machines and lathes and gives a standard form for test results documenting and reporting. This standard describes a testing procedure of 5 axis CNC machines (3 translations and 2 rotations), which considers the manufacturing of a truncated cone [27].

In [26] evaluations of different configurations of 5 axis manufacturing centers are presented from geometric, cinematic and dynamic point of view.

The undertaken studies in the field presents the modified DBB measurement device, where master balls are supported from the 45° direction to the spindle axis. It can perform all the circular tests on XY, YZ, and ZX planes without changing the setup [109].

An automated control system for error compensation, which uses mathematical models of the 5 axis, tool path models and cinematic models associated with the 5 axis, is presented in [94].

Generalized cinematic model is presented which allows automated obtainment of a specific configurations of a 5 axis using screw theory is presented in bibliographic source [65].

Another undertaken studies in this field, studies the problem of avoiding collisions during cutting on 5 axis machining considering a numeric algorithm which allows the modelling of obstacles. As results of the algorithm which simulates tool paths the adjustment times are cut short [94].

The undertaken studies in the field presents a geometric error compensation method is proposed using two different setting of the ballbar system, simultaneously on three axis [126].

Another method to compensate for deformation errors generated by temperature variation is presented in [59].

For precision testing of two rotation axis (named B and C) of rotary – tilting table a method which uses the ballbar system (Figure 2.3.12.) is proposed in this research. In figure 1 the 3D model of the ballbar system mounted on the rotary - tilting table is presented [27].

In case of two linear axes the ballbar system is testing the errors of circularity of the path programmed using circular interpolation functions. This circular path is used because it gives information about how well each of the two axis are operating and also how well the two axis can synchronize their motion in order to generate a circle [27].

Furthermore the ballbar system can track very easily the circularity errors. Circular interpolation functions are predefined in all NC equipment as G code functions G2 or G3. However there are no circular interpolation functions for circular path generated by two orthogonal rotation axis as it is the case of the rotary – tilting table [27].

In order to test the rotation axis we have to demonstrate that circles can be generated in such way that it will result as the combined motion of the two rotation axis and also find the relation between the two rotary axis motions in order to generate the circle [27].

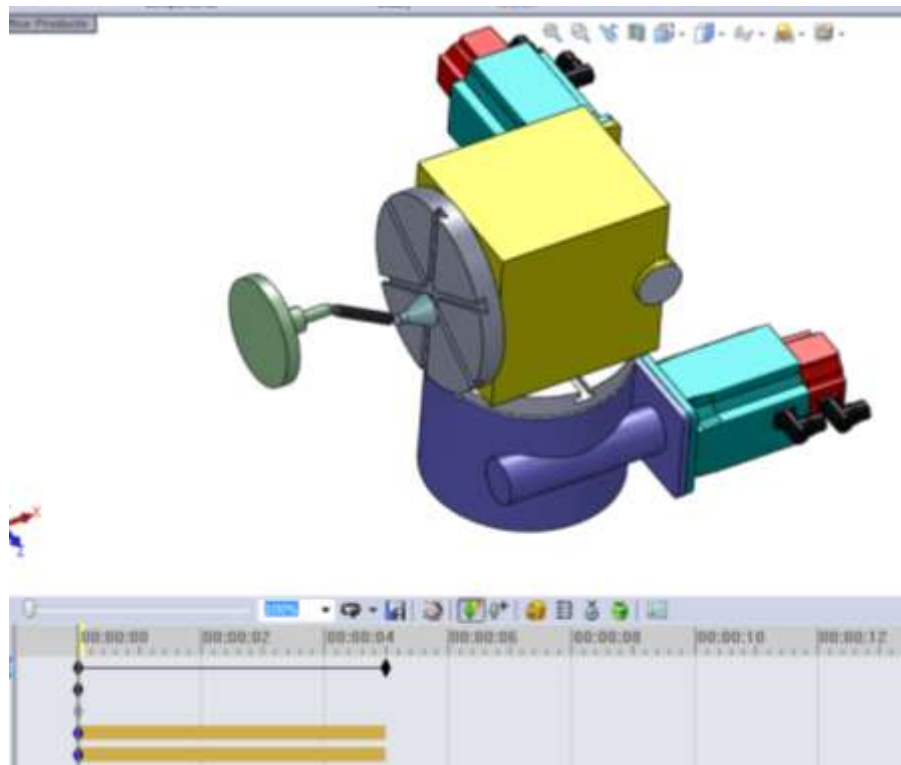

Figure 2.3.12. Verification of precision of two rotation axis (B and C) using the ballbar system [27]

In order to establish the path of point M the scheme shown in figure 2.3.13 is used [27].

We denote with M the centre of the ball mounted on the vertical table surface of the rotary – tilting table [27].

As we stated before we will have to find the correlation between the angle of rotation of the horizontal plateau (angle B) and the angle of rotation of the vertical plateau (angle C) so that the geometric place of the positions of point M have to be a circle [27].

To achieve this goal, some tri-orthogonal coordinate systems must be defined, each of them linked to an element in the measurement process [27]:

- Fixed system OXYZ linked to the centre of the ballbar ball mounted on the spindle of the machine tool. The Z axis is identical with the spindle axis;
- Fixed system $O_1X_1Y_1Z_1$ linked to the centre of the horizontal plateau;
- Mobile system $O'_1X'_1Y'_1Z'_1$ linked to the centre of the horizontal plateau;
- Mobile system $O_2X_2Y_2Z_2$ linked to the centre of the vertical plateau.

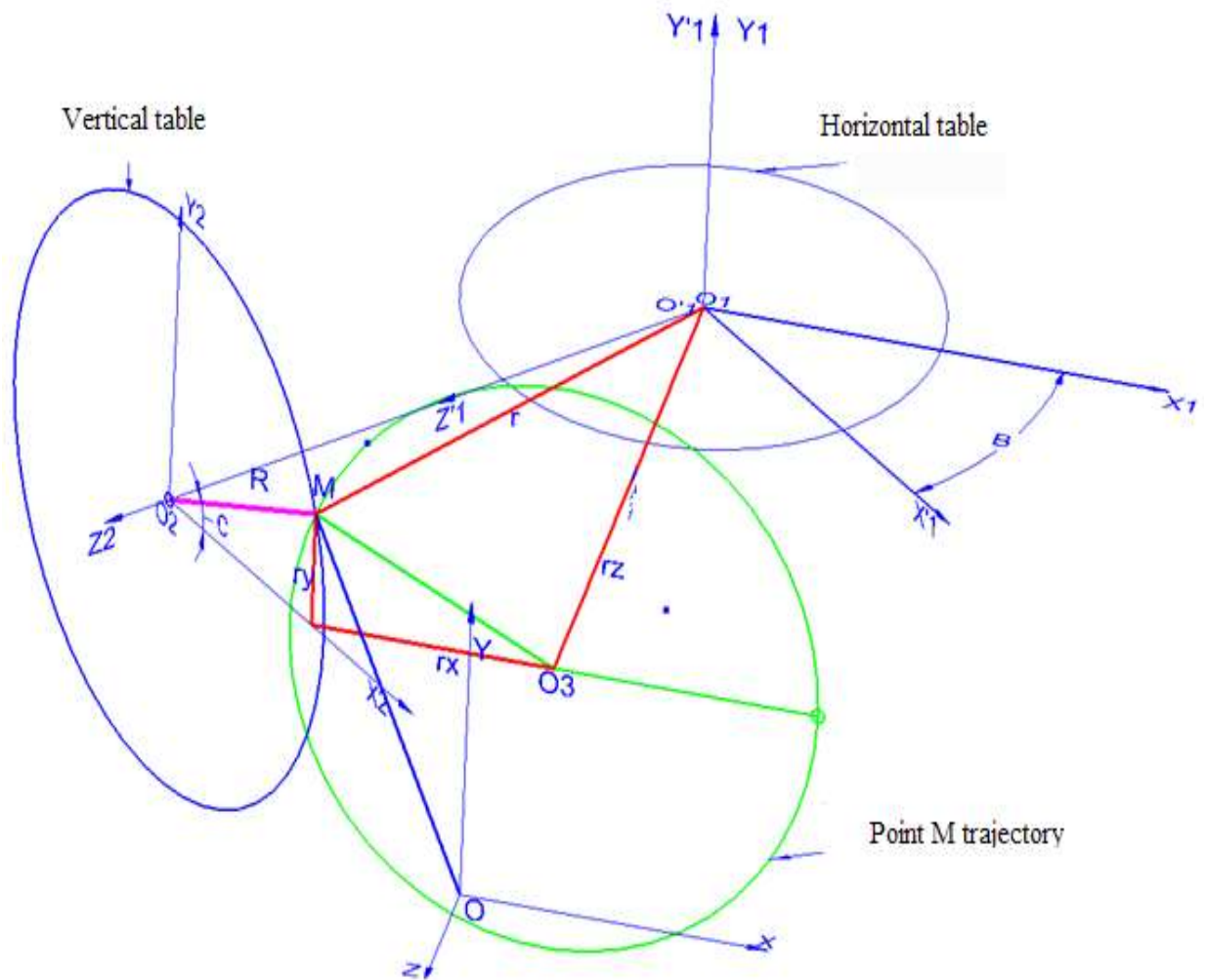

Figure 2.3.13. Schematics for computing point M trajectory [27]

Point M coordinates related to $O_2X_2Y_2Z_2$ system are given by the following equations [27]:

$$r_{2M} = \begin{cases} r_{2x} = R \cdot \cos C \\ r_{2y} = R \cdot \sin C \\ r_{2z} = 0 \end{cases} \quad (2.3.1)$$

In $O_1X_1Y_1Z_1$ mobile system the equations of point M are [27]:

$$r_M = M_{O_1O_2} r_{2M} \quad (2.3.2)$$

In homogene coordinates the transfer matrix is as follows [27]:

$$M_{O_1O_2} = \begin{pmatrix} 1 & 0 & 0 & 0 \\ 0 & 1 & 0 & 0 \\ 0 & 0 & 1 & d \\ 0 & 0 & 0 & 1 \end{pmatrix} \quad (2.3.3)$$

$$r'_{1M} = \begin{cases} r'_{1x} = R \cdot \cos C \\ r'_{1y} = R \cdot \sin C \\ r'_{1z} = d \end{cases} \quad (2.3.4)$$

In the fixed system $O_1X_1Y_1Z_1$, equations of point M are [27]:

$$r'_{1M} = M_{O_1O'_1} r'_{1M} \quad (2.3.5)$$

The transfer matrix is [27]:

$$M_{O_1O'_1} = \begin{vmatrix} \cos B & 0 & -\sin B & 0 \\ 0 & 1 & 0 & 0 \\ \sin B & 0 & \cos B & 1 \\ 0 & 0 & 0 & 1 \end{vmatrix} \quad (2.3.6)$$

After computation, the following expressions results [27]:

$$r_{2M} = \begin{cases} r_{1x} = R \cdot \cos B \cdot \cos C - d \cdot \sin B \\ r_{1y} = R \cdot \sin C \\ r_{1z} = R \cdot \sin B \cdot \cos C + d \cdot \cos B \end{cases} \quad (2.3.7)$$

From the condition that the trajectory of point M has to be in a plane [27]:

$$r_{1z} = d, \quad (2.3.8)$$

and replacing in the third equation of relations (7) we will obtain [27]:

$$C = \arccos\left(\frac{d - d \cdot \cos B}{R \cdot \sin B}\right). \quad (2.3.9)$$

Relation (9) expresses the correlation between the rotation and tilt angles, which can be used to generate an NC (G code) program, giving a set of values for angle B (for example from 1 to 360 with a step of 0.01 degrees) we will obtain the corresponding values for angle C [27].

Knowing the geometric elements of the rotary-tilting table, the authors developed a program to test the computation of angles B and C versus the trajectory of point M [27].

The flowchart of the program is given in figure 2.3.14 [27].

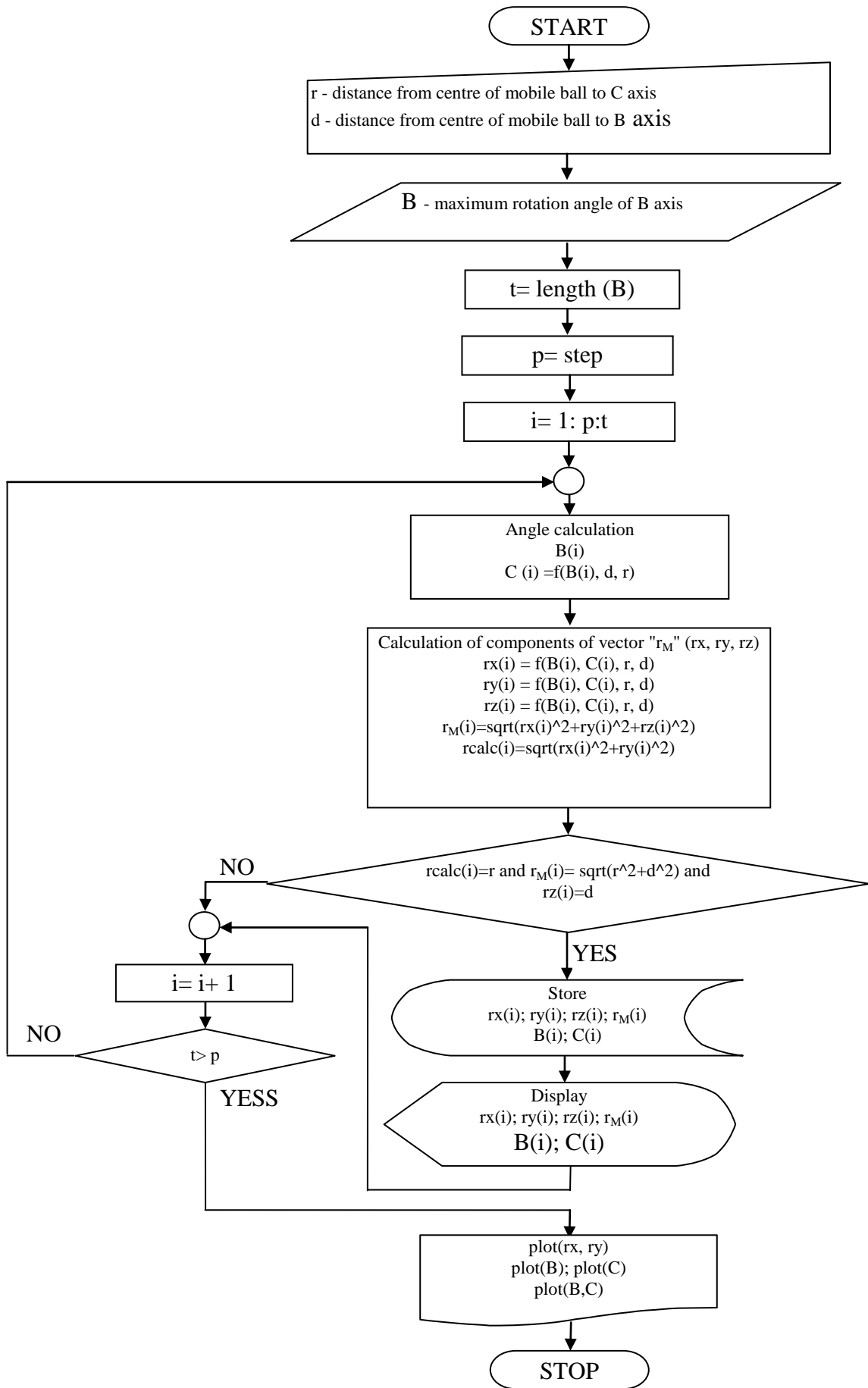

Figure 2.3.14. Flowchart for determination of point M trajectory [27]

The radius of ball centre on the vertical plateau is $R=100$ mm.

Distance from the centre of the ball to the centre of the horizontal plateau [27]:

$$d=239.433 \text{ mm}$$

Range of horizontal plateau angle (B axis) [27]:

$$B=-45:1:45 \text{ degrees}$$

Graphical representation of point M trajectory is given in figure 2.3.15 and in figure 2.3.16 the dependence of C axis rotation angle on the B axis rotation angle is shown [27].

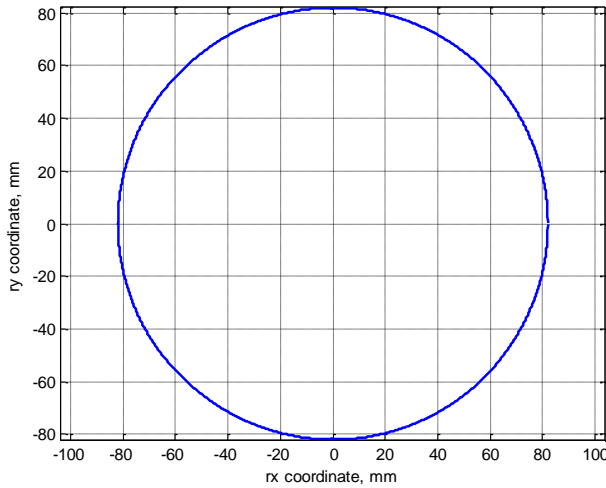

Figure 2.3.15. Trajectory of point M generated by the program [27]

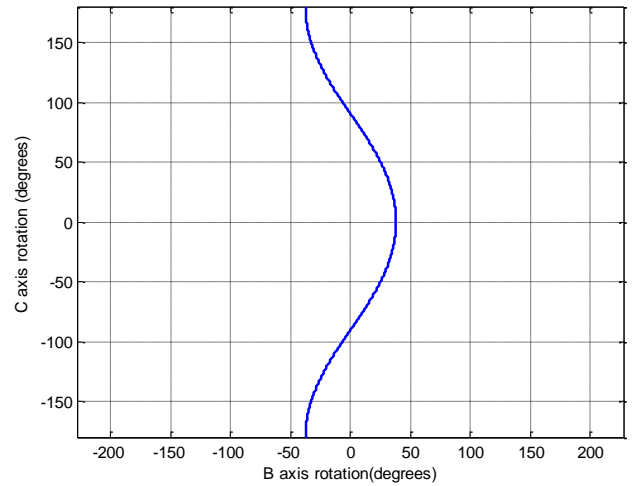

Figure 2.3.16. C axis rotation versus B axis rotation generated by the program [27]

In figure 2.3.17 evolution of B and C axis rotations are presented as function of points on the generated circle [27].

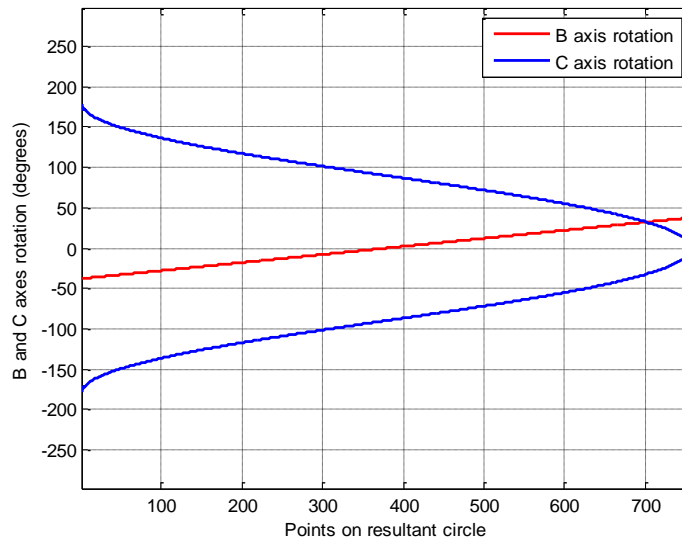
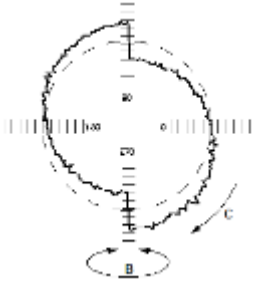
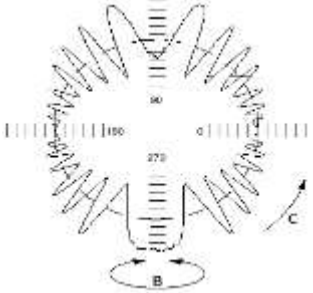
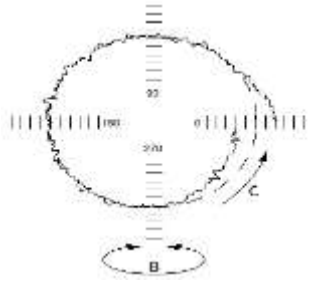
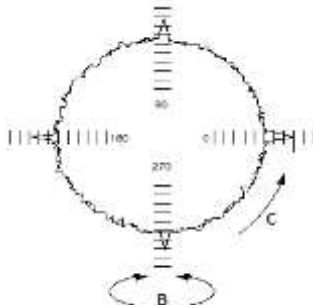
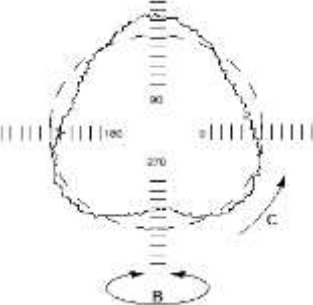
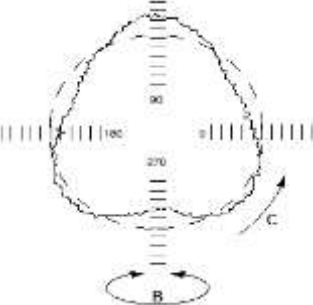
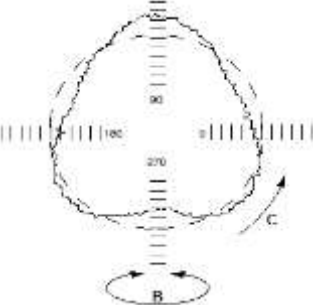

Figure 2.3.17. B and C axis rotation versus points on the generated circle [27]

1.1 Typical errors revealed by the ballbar system and their causes

In table 2.3.2 the typical possible error diagrams generated by the ballbar system during testing are presented with their causes [27].

Table 2.3.2 Errors and their causes [27]

<p style="writing-mode: vertical-rl; transform: rotate(180deg);">Diagram shape</p>			
<p style="writing-mode: vertical-rl; transform: rotate(180deg);">Cause</p>	<p>1. There may be play in the drive system of the machine. This is typically caused by worm end float or a worm drive nut.</p>	<p>2. An axis wormgear (in this case, the C axis) has a cyclic error problem or there may be an eccentricity in the encoder or wormgear mounting.</p>	<p>3. Can be an error of the ballbar mounting, the spindle may be unlocked and rotating, the part program may not match the software setup. In some cases, what appears to be a spiral plot can actually be unequal backlash</p>
<p style="writing-mode: vertical-rl; transform: rotate(180deg);">Diagram shape</p>			
<p style="writing-mode: vertical-rl; transform: rotate(180deg);">Cause</p>	<p>4. When an axis is being driven in one direction and then has to reverse and move in the opposite direction, instead of reversing smoothly it may pause momentarily at the turnaround point. There are several possible causes of this problem:</p> <ul style="list-style-type: none"> - An inadequate amount of torque has been applied by the axis drive motor at the axis reversal point causing it to stick momentarily at the reversal point, as the frictional forces change direction. - The servo response time of the machine is inadequate on backlash compensation. This means that the machine is unable to compensate for the backlash in time; causing the axis to stop while the slack caused by the backlash is being taken up. 		<p>5. The error is caused by the fact that the B axis of rotation is not vertical but tilted with a very small angle. (misalignment of B axis).</p>

1.2 Experimental results on the rotary – tilting table [27]

At the University of Oradea, Faculty of Management and Technology Engineering a 5 axis horizontal machining center had been developed [27].

This machine is equipped is a rotary – tilting table which adds two rotation axis (B and C) to the machines linear axis X, Y and Z [27].

The configuration of the 5 axis is presented in figure 2.3.18 and the mounted ballbar system is presented in figure 2.3.19, [27].

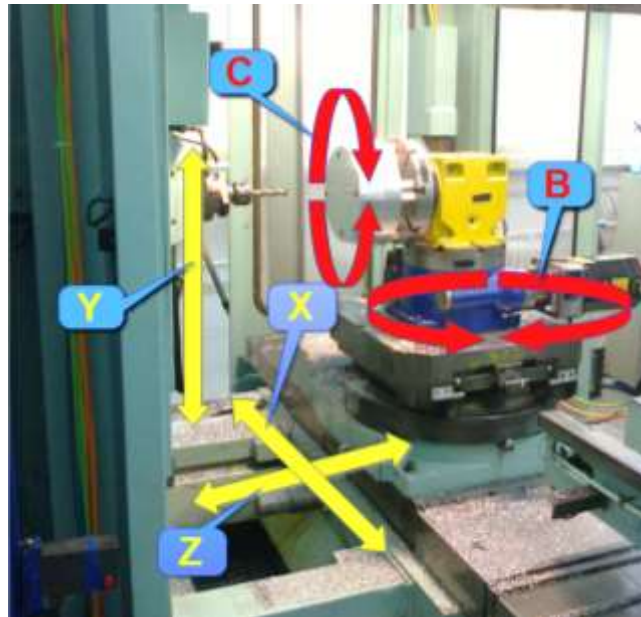

Figure 2.3.18. Five axis CNC machining center [27]

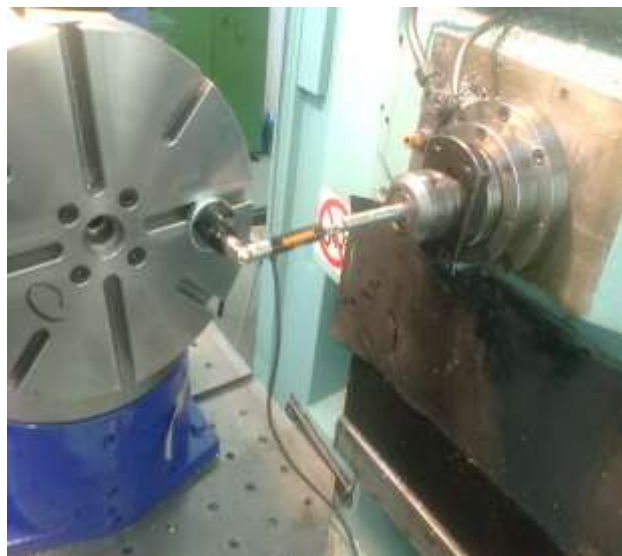

Figure 2.3.19. Mounted ballbar system for B and C axis testing [27]

After making the first set of measurements, the resulting ballbar diagrams had shown large errors which had been identified (based on cases presented in table 2.3.3) as unequal backlash in the wormgear assembly (Figure 2.3.20), [27].

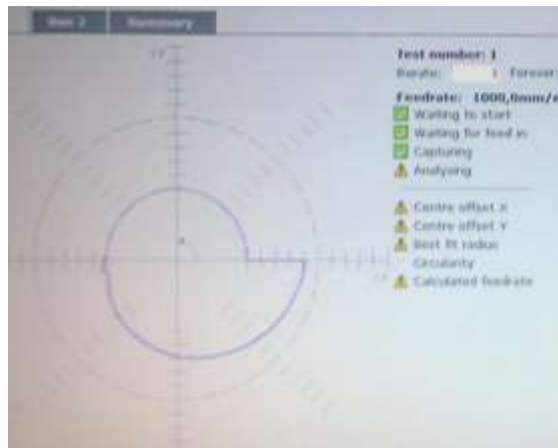

Figure 2.3.20. Errors caused by large unequal backlashes in the wormgear assembly [27]

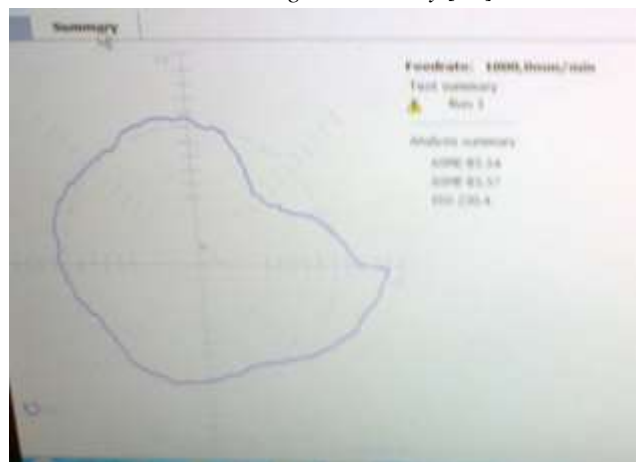

Figure 2.3.21. Error of misalignment of B axis in the vertical direction [27]

Another measurement had proved that there is also an error of misalignment of B axis in the vertical direction (Figure 2.3.21), [27].

Having indentified the causes of errors, measures had been taken to correct these errors and the ballbar tests had been made again. Resulting diagrams after the correction had been made shows that the errors had been eliminated as it is clearly shown in figure 2.3.22, [27].

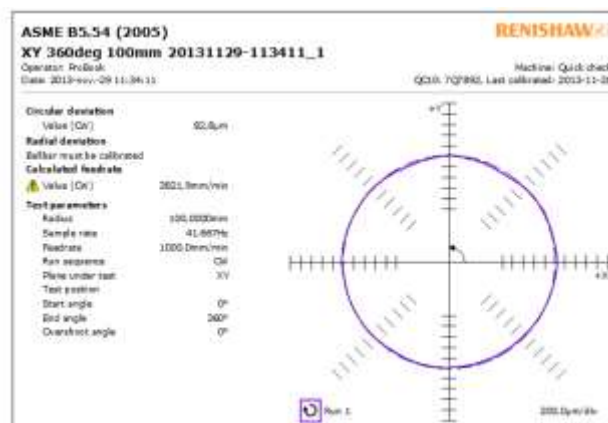

Figure 2.3.22. Error diagram for circular interpolation on B and C axis after the correction of wormgear assembly backlash [27]

3. RESEARCH APPLICATIONS IN UNIVERSITY EDUCATIONAL MANAGEMENT

3.1. Study on the mobility efficiency for doctoral student in research activity

Improving researchers' mobility and participating in study abroad programs represent key means for facilitating cross-border cooperation in research and innovation [22].

At specific individual level, involving in mobility programs during doctorate stage provide doctoral students with enhanced academic skills and improved research productivity, and this is the reason why mobility and study abroad programs are financially supported through many European funds and schemes [22].

The focus in this research is on a study-case, related to specific EU co-financed projects supporting Romanian doctoral students [22].

In order to investigate and evaluate main issues the effectiveness of different activities undergone abroad, we have conducted a deep and complex investigation among doctoral students from three Romanian universities, supported by three projects managed by University of Oradea, Romania [22].

The research is part of a wider project investigating relevant issues concerning the intellectual capital, social, learning and entrepreneurial skills of doctoral students and how EU financed programs to support doctoral students can contribute to enhancing their skills and abilities [22].

The higher education institutions (HEI) should be "more pro-active in providing postgraduates with the opportunity to develop the core competencies they need to succeed in a competitive job market" [22], [118].

It becomes essential that the programs for young scientists should be designed to ensure maximum efficiency of learning stages, an optimal combination between practical and theoretical skills. Benefits of study abroad seem to be obvious [22].

They can provide intellectual growth by acquiring new knowledge, validation and improvement of own research results, exchange of experience and contact with outstanding practical issues, improving knowledge of foreign languages, valuable professional and personal relations, tempering of biases and stereotypes, experience of a lifetime [22].

The mobility of students in general and particularly in the case of doctoral students has benefited, until the last decade, of few dedicated studies and research [22].

The only constant reference could be found in the extensive studies on international migration and population movements [22].

Mainly focused on the reasons of economic migration and asylum seekers, these studies mentioned, in a simple enumerative approach, also the international students' movement (sometimes as temporary migration), but specific figures were relatively poor. The situation began to change after the 2000s [22].

The OECD reports start to dedicate extensive research on students mobility [22], , and similar approaches could be find in IOM studies and reports [22], .

The analysis started to approach a more integrative and globalist perspective, marked by the internationalization of education together with the exacerbation/ worsening of skilled people migration [22].

In a detailed research on cultural processes reshaping the contemporary world, is emergence of new migratory elite, i.e. the European international students. International students in Europe seem to be the new citizens of tomorrow's world, where the home is just a starting place, and mobility an ordinary habit [22], [87].

Even if the research encompasses only a specific group of people, extrapolating the ideas of a united Europe also in terms of students' movements can be a good example of what we usually call human interconnectivity and global consciousness of a single space [22].

Praetzel and Curcio, consider that the learning stages and students' mobility may help to understand the cultures, persons and institutions in the host countries, develops "more open mindedness and tolerance, instils greater confidence, and promotes faster maturation" [22], [44], [97].

Comparing students' perceptions and predilection preferences of study abroad programs, in the found that students prefer short programs, completed under the supervision of faculty, instead of internships and whole semesters spent abroad [22], .

Evans et al reach the same conclusions, insisting that it must be found a *via media* between [22], [44]:

- a. students' preference for short study tours that accomplish specific educational objectives [22];
- b. the financial resources of students and universities to support complete and effective learning programs (regardless of training period abroad) [22];
- c. the needs of higher scientific performance (especially for doctoral studies) [22].

Analysing the international mobility of students with special reference to UK, King, Findlay and Ahrens, finds that "the UK is primarily a 'host' country for foreign students (two-thirds of whom are from non-EU countries), not an 'origin' country for international student mobility" [22], [70].

On the other hand, authors express their concern about this specific immobility and conservatism of UK native students, aggravated by the lack of effective openness to foreign languages studies or by the current regulations (i.e. Bologna process). They also mention the widely spread opinion that study abroad brings benefits (e.g. accumulation of valuable practical and theoretical knowledge, intercultural openness, flexibility), favouring higher degree of employment (or self-employment) [22].

However, the results based on extensive studies fail to appear and to prove undoubtedly this fact. Instead, there is a rich collateral "literature", fuelled by social media networks on individual cases of success stories in high employability of international students, deemed by the mentioned authors as "mostly anecdotal" [22].

More recently, [39] supports the idea that studying abroad has a "relatively large and statistically meaningful effect on the probability of being in employment 3 years after graduation" [22], [39].

The new developments in student mobility take new meanings [22], [23].

They found a persistence of these flows (with an increasing share of international students from Asian countries such as India or China), as well as a reverse phenomenon, the establishing of high-rated universities from USA, UK or France in developing countries, reaching the interest of million on students who cannot afford a study abroad [22].

Moreover, they mention the development of virtual platforms which deliver, in specific forms, valuable lectures to anyone, from anywhere, who has access to internet and a computer [22].

However, the authors underline the limitations of these substitutions: "they can never fully replace the kind of intense cultural learning experience of plunging into a foreign environment and mastering the linguistic and cultural and academic challenges studying abroad" [22], [23].

In order to evaluate main "facts and figures" on study abroad programs but moreover to investigate the effectiveness of different activities undergone abroad, we have conducted a survey during 9 to 12 January 2012 and developed a survey-based research by emphasizing Romanian doctoral students' attitudes and facts concerning issues such as: main activities and results achieved during stages abroad, main benefices and specific outputs, difficulties and limitations, aspects needed to be changed or improved etc., important to draw specific academic policies to enhance effectiveness and outputs of the stages abroad [22].

Online questionnaire was administered to all 110 doctoral students (in their first, second and third years of study) and recently graduated doctors who have been financially supported by POS DRU projects (POS DRU is the acronym for the EU funded program on Human Resources Development), coordinated by University of Oradea [22].

The questionnaire comprised 18 questions and a section for open answers, investigating various aspects and assessment of the stages abroad, such as activities achieved, general main achievements, specific outputs, difficulties of the stay, barriers to leaving, post-factum improvement suggestions or future intentions [22].

Finally, 88 doctoral students (out of 110 doctoral students representing the "total population") had responded to the questionnaire. Main description of the sample is as follows [22]:

Table 3.1.1. Description of the sample [22]

Study area	%	Occupational status	%
Engineering	29%	Full time doctoral students	26%
Philology	23%	Employed in education and research	48%
Geography	19%	Employed in public sector (excluding education and research)	9%
Economics	9%		
Biology	7%	Employed in private sector	6%
Medicine	6%	Self-employed	3%
History	6%	Others	8%
Sociology	1%		

As reported, 45 respondents (i.e. 51%) indicated they had passed at least once a stage abroad during the doctoral program [22].

The majority of them (i.e. 71%) were involved in short stages (up to 3 months), 16% in stages with duration of 4 to 5 months, and 13% of them in stages of 8 months [22].

Although the percentage of those who have benefited from stages abroad (i.e. 51%) is relatively modest compared with the expectations, a significant proportion of the respondents were 1st year students, while stages abroad were intended especially for 2nd and 3rd year doctoral students [22].

The figure 3.1.1 summarizes the main activities performed during the mobility stages, activities which are obviously related to the study field of the students [22].

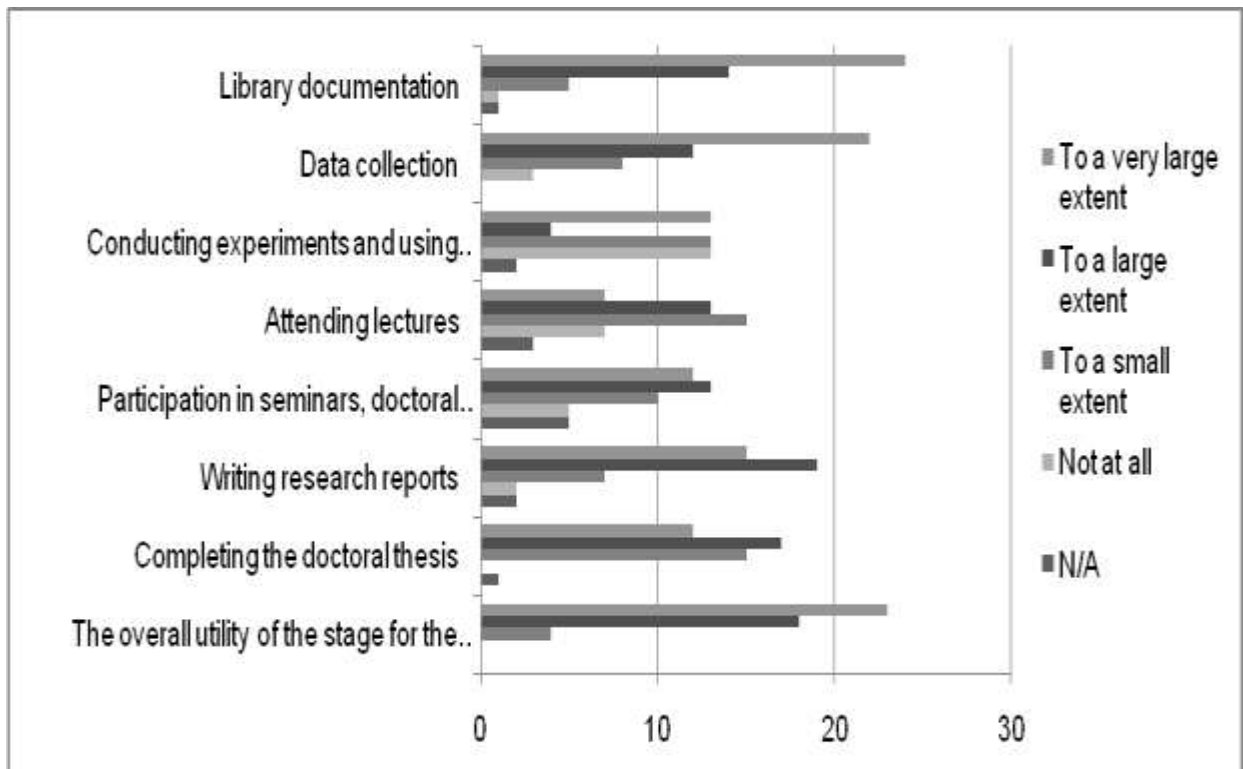

Figure 3.1.1. Responses to the question: "If you have already participated in a mobility stage, specify to what extent have you used internship abroad for ...?" [22]

As revealed by the responses, documentation in libraries and the access to sources of information, often unique or exclusive, seem to cumulate the most favourable agreements (i.e. 84% of the respondents assigned them "very large extent" and "large extent" agreements), followed by the data collection and the possibility of writing parts of the doctoral thesis (76% of the respondents assigned them "very large extent" and "large extent" agreements) [22].

The access to and use of laboratory facilities got moderate scores, maybe also due to the fact that the laboratory works aren't common in some doctoral areas [22].

The overall assessment on the internship abroad enjoy a very good score, i.e. 91% of the respondents considering the stages were beneficial to a large or very large extent. Interestingly, this score is significantly higher than any partial score reported on the above listed specific use [22].

It appears that the utility of studying abroad stages exceeds simple accumulation of knowledge or professional experience [22].

The benefices also reside on personal and professional contacts, personal and professional development, adapting to a stimulating environment, broadening the horizon and a valuable lifetime experience [22].

The opinions of the respondents express also the great utility and the benefices retrieved by them. Just to review some of them [22]:

- *"Mobility period was very beneficial because it brought me closer to the German discipline and rigour. I had the opportunity to perform a research report and the supervising professor and researchers helped me with new ideas (PhD student in Economics, female, married);*
- *"The opportunity to get documentation on the thesis subject was very useful, also the exchange of information with reputed specialists, establishing relations for further partnerships" (PhD student in Philology);*
- *"I managed to acquire essential knowledge, ... a huge difference in mentality between us and other nations (PhD student in Engineering, male, married);*
- *"We had a patient, empathetic supervisor, from whom I had much to learn ... it was a unique experience with many intellectual gains" (PhD student in Medicine, female, married).*

The utility of stages abroad for (doctoral) students is undeniable, even the efficiency of each component (e.g. research, writing reports, share experiences, cultural diversity etc.) is still the subject for deeper research [22].

Our first insights from the survey-based research carried out on 88 doctoral students and recent graduates of three public universities in Romania indicates the utility of these stages (i.e. appreciated by 90% of the respondents), and their extension within academic curricula should be considered. As revealed, doctoral students prefer short stages (with duration of up to 3 months) [22].

The benefices retrieved are related to both professional achievements by using documentation and experimental facilities, and personal development and acquiring new social skills and experience [22].

As specific activities performed, during stages abroad doctoral students achieved various activities, such as research, data collection and writing chapters of the doctoral thesis [22].

In terms of qualitative assessments, the openness and cooperative environment, the quality of advice and the opportunity to establish professional contacts were highly appreciated [22].

However, there are certain limitations of the research, both related to the relatively small number of respondents and to the early stage of the processing data [22].

Further research is needed as to process and investigate the data concerning the difficulties and barriers, in order to finally formulate adequate academic policies [22].

Finally, another issue to investigate may be the relation between the research results and experiences, and the developing potential of young researchers, for future career intentions [22].

3.2. Study on the promoting knowledge of sustainability in education curricula for technical MSc

Sustainable development is a key concept and also a real alternative to traditional, unfortunately not sustainable, development models. The effective challenge of implementing a sustainable development model is to promote as its main driver sustainability-oriented ventures, i.e. firms meeting both profitability, environmental and social requirements [10].

Nevertheless, as the entrepreneurs of the future are today's young people, and given that present entrepreneurial intentions are the best predictor of future entrepreneurial behaviour, we focus in this article on investigating students' attitude towards involving in sustainability-related businesses [10].

Therefore, was developed a survey-based research among master students in Business Administration and Managerial Engineering from a Romanian public university as to reveal their availability for sustainability-related entrepreneurial career, their understanding on what sustainability really means and which specific actions are they expecting to undertake in this direction [10].

Furthermore, we found out that students expect from universities (including academic curricula, specific academic programs, specific lectures etc.) to be the most important "provider" of adequate entrepreneurial, sustainability-related skills and abilities. Consequently, universities should seriously take into consideration adjustments in their strategic actions in the direction of a closer link with the business environment and a more effective involvement in promoting sustainable economic development [10].

Sustainable development is still a subject of debate in economic, environmental, social and cultural frames. A pragmatic decoding of its meaning becomes increasingly important: how to understand sustainable development, how it addresses humanity's concerns, how it helps to structure responses and who are responsible to promote a new model of economic development? [10]

The research aims to examine how graduate (master) students perceive launching and running (sustainable) businesses as an effective alternative career, which are the directions of this business behaviour and on whom rely the main responsibilities in guiding them towards promoting sustainability, or, in different words, to find out whether and in what extent master students' expectations regarding future business opportunities (or successful integration into the labour market) are powered by the knowledge and skills provided by academic programs [10].

The issue of economic development and its environmental and social implications enjoy a rich and highly diverse literature [10].

Most approaches have focused on potentially negative consequences derived from changing natural environment (i.e. global warming) and economic challenges (i.e. mass unemployment, industrial decline) resulting from an increasingly globalized economy and society, the scarcity of natural resources, the rapid pace of human development and its implications for future generations [10].

Thus, sustainable behaviour has become a reference point and a solution to today's environmental and societal challenges as it has been clearly stated by Brundlandt Report (WCED - World Commission on Environment and Development), which defines sustainable development as "the development that meets the needs of the present without compromising the ability of future generations to meet their own needs" [10], .

Consequently, there are high expectations that government, civil society and individuals respond to these environmental and societal challenges. However, the limits of each of them

emphasized the predominant role of private economic actors in addressing sustainability issues [10].

The link between economic behaviour, sustainability and opportunities is widely described in [112], [113] or [74], [41] promotes the idea of a “triple bottom line”, where businesses of all sizes can meet the profitability, environmental quality and social justice. Their researches underline that private initiative and the inquisitive nature of the entrepreneur do have the potential to generate radical innovations which can simultaneously contribute to sustainable development and increase social welfare [10].

This type of economic behaviour is a better alternative to end-of-pipe interventions (specific to governmental regulations and projects), which probably mitigate the negative impact of human activities on the environment and communities but instead certainly consume huge funds that could be used in other areas [10].

The majority and, chronologically, the first studies on the relationship between private business and sustainable development outlined the central figure of the environmentally oriented entrepreneurs [10], [115], [124], [114], those who use specific business tools to help preserve the environmental quality [114]. The second school of thinking focuses on the social aspects of sustainability [10], [98], [99], [78], concerned to find solutions as poor or marginal categories of society could access scarce resources, education and innovation [10], [37], but in terms of sustainable development.

These include, in addition to “classic” entrepreneurs, the private initiative in the social economy and the non-profit ventures [10], [125]. Integrating researches, which attempted to unify those two streams of sustainability (i.e. environmental and social), have focused on the essential traits of entrepreneurship, i.e. the availability to innovate and the ability to discover opportunities [10], [24], [60], [38].

Once understood that specific tasks of sustainable development can be assigned to entrepreneurship, policy makers and the education system (in particular HEI) have raised the question of what can be done to foster students' entrepreneurial intentions and abilities to discover and exploit economic opportunities related to sustainable development [10].

Starting from the idea that actual behaviour is best predicted by previous intentions, a number of features that prefigure entrepreneurial profile was identified, such as risk taking, optimism, curiosity, interaction with others [10], [47], [55], and a series of specific contextual factors that either favour or hinder entrepreneurial actions available to young students.

Thus, Lüthje and Franke [10], [77] showed that all contextual factors perceived as barriers should be identified and diminished.

At the same time, HEI should encourage supporting elements moving towards entrepreneurship. The symbiosis between correct understanding of entrepreneurship and inspired educators will lead to higher levels of entrepreneurial intentions among students [10], [116].

Considering the fact that the perception of specific entrepreneurial opportunities depends on prior individual knowledge [10], [117], researchers have sought to identify how shaping of sound environmental values generates students' involvement in voluntary actions to protect the environment and help the perception of entrepreneurial opportunities resulting from unsustainable economic behaviour [10], [38].

Based on data collected from students and graduates in science, engineering and business programs from three European universities, [10], [73], found that students with a stronger orientation towards sustainable business are more likely to moving towards entrepreneurship, but

also that business experience diminishes the positive relationship between orientation towards sustainable business and entrepreneurial intentions [10].

In a research performed for Higher Education Academy, [28] found that 65% of first-year UK students assert that universities should include and promote sustainability in their courses [10].

A large majority of the students (around 80% of them) consider that sustainability-related skills are required on labour market; hence, HEI have to prepare the students for the requirements of their future carrier. At the same time, the analysis indicated a very low percentage of students who are effectively involved (not just declarative) in sustainable projects [10].

UNESCO Report "Education for Sustainable Development" analyses information on how learning processes are aligned with sustainable development and the key processes which enhance the education for sustainable development practices, i.e. cooperation between HEI and business environment, and participatory learning. The authors suggest that education for sustainable development has to go beyond simply acquiring values, theories and knowledge [10].

Education for sustainable development should encourage students to put critical questions and think in a practical and innovative manner [10].

The report highlights the need to find the optimal combination between formal education (i.e. based on irrefutable scientific results), informal education and learning experiences [10].

In a large research on students' attitudes towards and skills for sustainable development within UK universities, conducted in two phases, in 2010 and 2011, [40] reached the following conclusions [10]:

- The education system remains the main vehicle for accessing knowledge on sustainable development, albeit the level and structure of knowledge (as revealed by the responses) is somewhat confused and unsystematic. It appeared that the progress over the years of study is not conclusive, indicating either a limitation of the absorption of new knowledge, either a need to rethink the university curriculum [10];

- Students "believe that the core skills for sustainability are both relevant to their course and important for graduates in their field" [40]. Students' understanding of the skills for sustainability appears to be limited only to natural environment preservation and business ethics, while the set of advanced knowledge and skills for sustainable development are not well clarified or valorised by them [10];

- Finally, respondents show some interest in developing their skills for sustainable development, adequate for the labour market, and the highest expectations are attached to the universities and business environment (referred by 75-80% of respondents). Overall, respondents showed a clear preference (expressed by 63-68% of them) that courses' content should combine theoretical knowledge with social and environmental skills rather than to add supplementary content [10].

Aiming at investigating relevant issues concerning entrepreneurial attitudes and orientation of post-graduate (master) students, we have conducted during February 2013 and February 2014 an extended survey and developed a sample-based study [10].

In the present research we focus on emphasizing students' attitudes concerning sustainability, particularly sustainable business and sustainable entrepreneurship, as to reveal their understanding and propensity to establish and run sustainable ventures [10].

Paper and pencil questionnaires were administered to 174 master students in Business Administration and Managerial Engineering (1st and 2nd year) from a Romanian public university, namely University of Oradea [10].

Main description of the sample is as follows [10]:

Table 3.2.1. Description of the sample [10]

Occupational status	%	Gender	%
Full time master students	26	Males	48
Master students, with full-time job in public sector	4	Females	52
Master students, with full-time job in private sector	51	Matrimonial status	%
Master students, with part-time job in private sector	9	Single	90
Master students, entrepreneurs or self-employed	10	Married	10
		Residence	%
		Cities	62
		Small towns	11
		Rural areas	27

The availability of young students for a career directly related to sustainable development has been revealed by the fact that over 58% of respondents declared to be willing to open a business that takes into account the sustainability related opportunities, while the rest (42%) didn't consider the issues of sustainability for the future business or the career plan [10].

For this second category of respondents, the business they will develop or the desired job will not necessarily be opposed or insensitive to sustainability [10].

Simply they perceive their future business or job as circumstantial and adapted to realities and moment's timelines rather than strictly following ethical, environmental or social principle [10].

The significant percentage of masters students "neutral" to sustainable development, both as a business opportunity and as general behaviour, makes us inquire to what extent interviewed students (as a whole group) actually understand the concept of "sustainable business", and how they express this sustainability in business terms [10].

Thus, for the first part of the question we found the following distribution of responses [10]:

Table 3.2.2. Responses to the question: "Are you familiar with the concept of sustainable businesses?" [10]

	Number of responses	Share
Yes, mostly	65	37%
I have some idea	74	43%
I heard the expression, but I don't know exactly what it means	26	15%
I have no knowledge about the concept and I have never heard of it	9	5%

At a first glance, it would seem that the cumulative percentage of the first two options ("yes" and "I have some idea") are comfortable (i.e. 80% of the responses), which would make us to believe that a large part of the people previously self-declared as "neutral" to sustainable development could become future entrepreneurs or employees in companies involved in sustainable development [10].

On the other hand, we are quite cautious in accepting these responses as satisfactory. Neither the choice "in a large extent", and even less "I have some idea" are not sufficient to indicate a significant knowledge of the principles of sustainable business [10].

We should not forget that the target group consists of master students in Business Administration and Managerial Engineering, whose training curricula and individual options clearly indicate a certain orientation towards business opportunities, and sustainable and innovative ventures [10].

Beyond the distribution of the responses to the four above alternatives, it is very suggestive how respondents describe their understanding of sustainable business, in straight, brief phrases. Here are some selected answers provided by respondents on the question on "what do you mean by sustainability in business" [10]:

- "Businesses that support environmental protection, trying to maximize the operating period" (male, 1st year master student in Business Administration) [10];
- "Long-term business using local resources, promoting local goods and services" (female, 2nd year masters student in Business Administration) [10];
- "Businesses that promote ecological products and services" (female, 1st year master student in Business Administration) [10];
- "Business, different than usual ones, and based on new ideas and innovations" (male, 1st year master student in Business Administration) [10];
- "A long-term profitable business with low cost of resources" (male, 1st year master student in Managerial Engineering) [10];
- "A business of the future, that brings sufficient income for the entrepreneur but also capable to protect the environment in which it operates" (male, 1st year master student in Managerial Engineering) [10].

Like most studies cited in literature and reviewed by us in the dedicated sections of this research, much of the understanding of sustainable business is circumscribed to ecology and environmental issues [10].

The concept of sustainable development is overlapped to the concept of environmental sustainability [10].

The efficiency of using existing resources, and the social, community or business ethics issues occur less frequently among responses. Respondents tend to consider sustainability issues as not related to the whole economy, but rather limited to specific business models or for certain economic sectors, e.g. sectors based on exploiting natural and cultural resources and “green” products, such as tourism, personal care and services, agriculture etc [10].

Moreover, the opinions which consider sustainability as a new business paradigm should be appreciated. For these respondents, sustainability doesn’t mean improving “classic business” through environmentalism or social voluntarism insertions, but rather addressing real challenges of the contemporary world [10].

Consequently, the “unsustainable” behaviour is both a danger and a business opportunity for the “entrepreneurs of sustainability” [10].

With regard to students’ perception on the necessity to protect the environment and the natural resources (i.e. agreement with the statement “it is important that my business protect the environment”), over two thirds of respondents declare a “strongly” agreement, and when cumulating both “strongly” and “partial” agreement, the percentage is over 93% [10].

Furthermore, when investigating how prospective entrepreneurs do understand to apply the principles of sustainability into practical and specific forms, and to move to specific, “real actions”, we found the opinions resumed in Figure 3.2.1, [10].

Summing up the responses of “strongly agree” and “partial agree” also for the following options, we note that prospective entrepreneurs are interested to use renewable energy (i.e. 85% of them), to recycle products (i.e. 88%), to use local products (i.e. 76%) and to employ local workforce in their future businesses (i.e. 88%) [10].

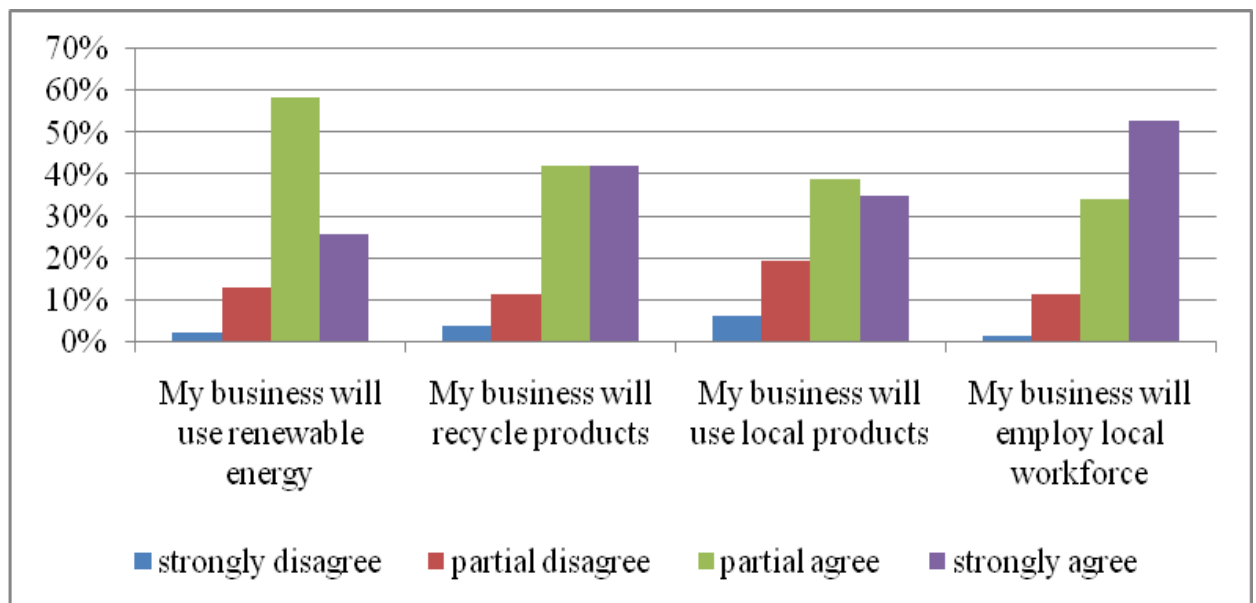

Figure 3.2.1. Respondents’ agreement with selected statements [10]

Interestingly, the agreement on the requirements of sustainability-guided businesses appears to be stronger for the general principle (i.e. 92% of the respondents expressing strongly or partially agreement) than for specific, “real actions” (such as using renewable energy, using recycle products, using local products or employing local work force) [10].

Certainly, this difference can be explained at first sight by the contrast between declarative statements and practical implementation of sustainability. Furthermore, it is involved a multitude projections of future business and strategies, very specific to the sector within the venture will effectively act: while in some sectors saving energy or recycling prevail, in other sectors entrepreneurs valorise the use of local products or resources [10].

What is really important is that future entrepreneurs prepare their future businesses by integrating both theoretical and practical aspects, when they found and exploit opportunities related to sustainable development [10].

Finally, when asked about the persons or entities entitled to promote and foster the implementation of sustainable businesses, the highest expectations of students on providing skills for sustainable business or to maximize chances for a successful insertion on labour market are attached to universities (Figure 3.2.2), [10].

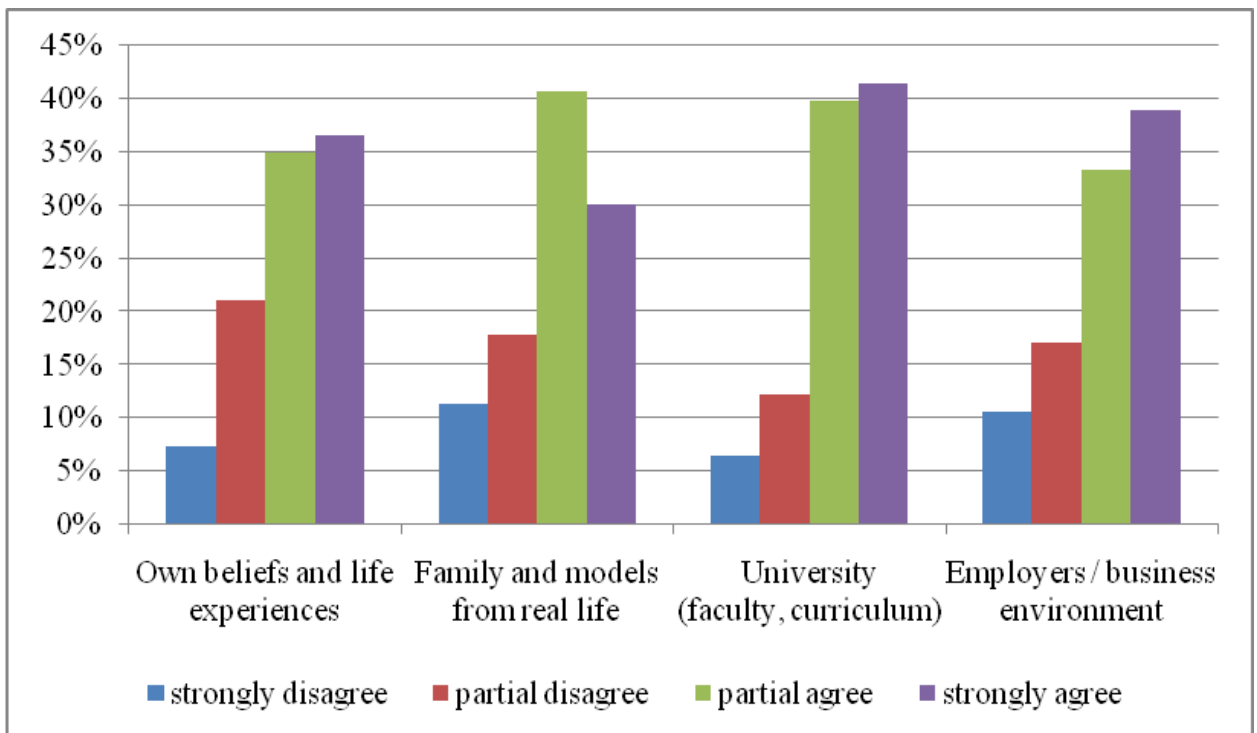

Figure 3.2.2. To what extent do you agree with the following statements: “In my training for the implementation of sustainable businesses, the greatest responsibility lies to ...” [10]

Thus, if we cumulate the percentage of “strongly agreement” with “partial agreement”, universities get a total percentage of 81%, followed by employers (businesses environment) and personal determination with 72% and, very close, the influence of family and models with 71% [10].

Students expect mainly from universities to get “endowed” with the abilities and competencies necessary for a future business orientation for sustainability [10].

We find that the closeness between universities and the business environment and a more business-oriented academe express students’ desire to find in the academic curriculum valuable scientific knowledge and practical skills for sustainable development, adjusted to the effective requirements of the real business world. It is, as we have shown in the previous paragraphs, an

interlocked of theoretical and practical aspects, related to providing useful entrepreneurial skills required by the market and the business environment [10].

Students expect that knowledge and skills acquired during university's stages to maximize the chances for running their own business or for successful insertion in the labour market. The fact that universities and business environment are connected together and assess as main responsible actors for students training in sustainable business represents a highly honourable yet challenging duty. Certainly, this responsibility does not exclude other adapted solutions, more or less formal, used by HEI to meet expectations and individual needs of their students [10].

Sustainable development is a referential point, equally inspiring and controversial, of contemporary economic, social and political life. In this context, entrepreneurship is increasingly regarded as a solution for a sustainable transformation of products and business processes, to environmental, social or community's challenges of our society [10].

Studies have shown that actual behaviour is predicted by prior intentions, and perception of specific entrepreneurial opportunities depends on individual knowledge previously accumulated. Consequently, policy makers and HEI are facing a considerable challenge: what should they do to encourage both general entrepreneurial intentions and the orientation to identify and exploit economic opportunities related to sustainable development [10].

For a better understanding of these issues, we have conducted during February 2013 and February 2014 an extended survey on 174 master students in Business Administration and Managerial Engineering from a public university in Romania, aiming at investigating their understanding on what sustainable business means and their propensity to get involved into sustainable ventures [10].

The research revealed a widespread acceptance of the imperatives of sustainable development in students' future career, even the concept and practical implementation of "sustainability" is sometimes confused and sometimes circumscribed to activities essentially related to natural resources, environmental quality and preservation of traditional communities [10].

The large majority of respondents anticipate that the businesses they will manage (as future managers or entrepreneurs) will be strongly concerned by saving energy, recycling, valorising the local resources and workforce and other sustainability-related practices. At the same time, respondents have modest propensity and ability to find new opportunities correcting unsustainable economic behaviour or changing the traditional business model, less environmentally friendly or protective with the small communities' future [10].

The research also analysed students' expectations regarding the responsibilities to prepare them for future sustainable business model. Personal responsibility plays an important part in this regard, but the main role is assigned to universities, closely followed by business environment or employers [10].

Similar to other research results conducted in academic institutions around the world, students expect from universities to develop tailored, adapted programs, where scientific information be combined with practical skills. Students' expectations go especially for a creative collaboration with businesses in order to set up really useful graduates programs for the real world and economy. To what extent HEI and businesses are actually prepared for fast and efficient transformations may be the topic of further investigation and future research [10].

C.**THE EVOLUTION AND DEVELOPMENT PLANS OF THE PROFESSIONAL CAREER**

As doctoral supervisor in the Engineering and Management domain I will promote new research directions which will provide a “value added” at national as well as international level. Also I will have in focus the development at a national level of the domain of Engineering and Management by speeding up activity and consolidating CIER (Consortium of Economic Engineering in Romania) [153] and AMIER (Romanian Managers and Economical Engineers Association) and also by implying the development of a network of this domain at international level.

In the future the new research directions will have as subjects: Lean Six Sigma and Advanced Manufacturing and Processing.

If Lean Management reduces loses and 6σ reduces the scraps, Lean Six Sigma imposes the acceleration of the implementation of efficient processes. 6σ is named after a statistical concept where a process only produces 3.4 defects per million opportunities (DPMO) . Attention will be focused not only on implementing 6σ in the manufacturing processes but also on management education processes, administration and even in public health.

Advanced Manufacturing and Processing (AMP) comprise production systems and associated services, processes, plants and equipment, including automation, robotics, measurement systems, cognitive information processing, signal processing and production control by high-speed information and communication systems .

AMP involves manufacturing operations that create high-tech products, use innovative techniques in manufacturing and invent new processes and technologies for future manufacturing [29].

Development of academic career to promote performance in doctoral supervision is put in practice by participating in present but also in the future in actions of university educational projects which supports doctoral and postdoctoral research.

According to this, in the project POS-DRU 159/1.5/S/137832 (2014-2016) direction 1.5 „Doctoral and post-doctoral programs for research support”, Title: „MINERVA – Cooperation for elite career in doctoral and post-doctoral research”, coordinated by the Romanian Academy I have the function of long term expert for monitoring – evaluation of scientific results.

For the development of professional and academic career, in the present, I participate in the framework of the project: POSDRU/161/2.1/G/133930, Direction 2.1 “Transition from school to active life”, project title: “Support for a successful career in reverse engineering”. As expert I develop materials necessary for the operation of “Reverse Engineering” Simulated Enterprise.

In the domain of Engineering and Management in the present I am implied in two PNII projects as a researcher:

- a. PN-II-PT-PCCA-2013-4-0616 (2014-2016) “Researches based on knowledge management regarding cooperation between industry and universities in open innovation”.
- b. PN-II-PT-PCCA-2013-4-1462 (2014-2016) “Energy management system for energy obtained from renewable sources in small isolated communities”.

As a CEEPUS network coordinator (“CIII-BG-0613-04-1415 „*Nanotechnologies, materials and new production technologies - university cooperation in research and implementation of joint programs in study by stimulate academic mobility*”)for the University of

Oradea I will search new joint research directions, together with the other universities from Austria, Bulgaria, Czech Republic, Poland, Slovakia, Slovenia, Serbia and Hungary.

This project creates cooperation opportunities and good practice exchanges for doctoral students and supervisors as well.

As an action plan is useful to apply the “intelligent research” concept which is also promoted in the framework of “HORIZON 2020” [155].

There will also be a priority to put in practice research results by association with economical partners.

REFERENCES

1. Abrudan I., Candea D., (ș.a.) *Manual de Inginerie Economica, Ingineria si Managmentul Sistemelor de Productie*, Editura Dacia, Cluj-Napoca, 2002.
2. Ajit K. S., Singh N. K., Shankar R., Tiwari M. K., *Lean philosophy: implementation in a forging company*, Int J Adv Manuf Technol, Vol. 36, pp. 451–462, 2008.
3. Andrew C., Dan C, *The Limits of Lean Management Thinking: Multiple Retailers and Food and Farming Supply Chains*, European Management Journal Vol. 23, No. 6, pp. 648–662, 2005.
4. Anand G., Rambabu K., *A multi-criteria decision-making model for the justification of lean manufacturing systems*, International Journal of Management Science and Engineering Management, Vol. 3 No. 2, pp. 100-118, 2008.
5. Adrian V., Viorel M., Morten P., Jens F., *“Lean and Green” at a Romanian secondary tissue paper and board mill—putting theory into practice Resources, Conservation and Recycling* 46, pp. 44–74, 2006.
6. Ahn, K.G. and Cho, D.W., *Proposition for a volumetric error model considering backlash in machine tools*, Int. J. Adv. Manuf. Technol., Vol. 15, pp. 554–561, 1999.
7. Apro, K., *Secrets of 5-Axis machining*, Industrial Press, New York, 2008.
8. Anthony Chukwujekwu Okafor, Yalcin M. Ertekin., *Vertical Machining Center accuracy characterization using laser interferometer Part 1: Linear positional errors*, Journal of Materials Processing Technology, Vol. 105, nr. 3, pp. 394-406, 2000.
9. Anderson, T.; Leal, D. *Enviro-capitalists. Doing Good while Doing Well*, Rowman & Littlefield: Lanham, MD, Vol. 3, 1997.
10. Badulescu D., Bungău C., Badulescu A., *Sustainable Development through Sustainable Businesses. An Empirical Research among Master Students*, *Journal: Sustainability*, (in curs de publicare).
11. Bungău, C., Blaga, F., Băban, C., *Studiu asupra calculului de optimizare al capacității de producție utilizând matlab*, Revista de Management și Inginerie Economică nr.1, pp. 79-81, 2002.
12. Blaga, F., Bungău, C., *Asupra optimizării planificării producției utilizând teoria mulțimilor vagi (Fuzzy)*, Revista de Management și Inginerie Economică nr.1, pp. 25-31, 2002.
13. Bungău, C., Hegedus, J.A, Rosca, L. *5S introducing in PVC window systems production*, Proceedings, [Annals of the Oradea University. Fascicle of Management and Techological Engineering], pp. 212-215, 2007.
14. Bungău, C., Lucaciu, I., Pancu R., Ganea M., *Kaizen implementation to reduce production loss (waste)*, Revista de management și Inginerie Economică (Review of Management and Economical Engineering), 2009.
15. Bungău, C., Gherghea, I., C., Prichici M., *Value stream mapping analysis, efficiency methods of operational management*, Proceedings of the 1st Management Conference on 20 Years After: How Management Theory Works, Cluj Napoca, pp. 188-198, 2010.
16. Bungău C., Blaga F., Gherghea I,C., *Method of analysis and audit, used to implement 5s in operational management*, Conference: 2nd Review of Management and Economic Engineering Management Conference (RMEE), Proceedings of the 2nd Review of

- Management and Economic Engineering Management Conference: Management of Crisis or Crisis of Management?, pp. 36-47, 2011.
17. Bungău C., Groza M., Buidos T., Gherghea I. C., *Measurement system used in the implementation of 5S*, pp. 667-679, International scientific assembly ES-NBE 2011 Economic Science in Function of Creating a New Business Environment, Univerzitet U Prištini, Ekonomski Fakultet, Zbornik Radova, 2011.
 18. Bungău C., Blaga F., Gherghea I. C., *Continuous improvement of processes in cutting operations*, Proceedings of the 3rd Review of Management And Economic Engineering International Management Conference, „Management of Crisis or Crisis of Management ?” pp. 208-216, Cluj- Napoca, 2012.
 19. Bungău C., Blaga F., Gherghea C., *Kaizen implementation for cost reduction in manufacturing process product "driver control board"*, International Conference on Production Research – Africa, Europe and Middle East, ICPR-QIEM, 2014.
 20. Bungău C., Pancu R., Buidos T., *Analysis of the Linear Positioning Accuracy on Z Axis at the Horizontal Machining Centre TMA-AL-550*, *Advanced Materials Research*, Modern Technologies in Industrial Engineering, Vol. 837, pp. 179-184, 2014.
 21. Bungău, C., Lucaciu, I., Lucaciu I., Barabas, T., Rangona, E., *Retrofitting- a technical solution adapted to sustainable development principles*, Annals of the Oradea University. Fascicle of Management and Techological Engineering, pp. 1980-1985, 2008.
 22. Bungău C., Badulescu A., Badulescu D., *Assessing the effectiveness of mobility and study abroad stages during doctoral programmes: a case-study*, 13th European Conference on Research Methodology for Business and Management Studies ECRM, London, 2014.
 23. Bhandari, R. and Blumenthal, P., *Global Student Mobility: Moving towards Brain Exchange*. In: R. Bhandari & S. Laughlin, eds. *Higher Education on the Move: New Developments in Global Mobility*. New York: AIFS Foundation & Institute of International Education, pp. 1-13, 2009.
 24. Bhave, M. *A Process Model of Entrepreneurial Venture Creation*. *Journal of Business Venturing*, Vol. 9 (3), pp. 223–242, 1997.
 25. Bahram S., *Regional hydrologic mapping of flows in stream networks*, *International Journal of Applied Earth Observation and Geoinformation*, Vol. 11, pp. 317–323, 2009.
 26. Bossoni, S., *Geometric and Dynamic Evaluation and Optimization of Machining Centers*. Zurcher Schriftenzur Produktionstechnik. Fortschritt-BerichteVDIReihe 2 Nr. 672. Dusseldorf: VDI-Verlag, 2009.
 27. Blaga F., Bungau C., Stanasel I., Vesseleniy T., Pancu R., Craciun D., *Researches regarding rotary –tilting table precision evaluation method using the ball-bar system*, Proceedings of the Romanian Academy, Series A, Volume 9, Number 1.
 28. Bone, E.; Agombar, J. *First-year Attitudes towards, and Skills in, Sustainable Development*, The Higher Education Academy: Heslington, York, 2011.
 29. Caroline M. Sallee , Erin Agemy, Alex L. Rosaen, *The University Research Corridor Support for Advanced Manufacturing in Michigan Michigan State University*, University of Michigan, Wayne State University.
 30. Colin H., Paul M. B., *A methodology for developing sustainable quantifiable productivity improvement in manufacturing companies*, *Int. J. Production Economics* Vol. 104, pp. 143–153, 2006.

31. Castro, H. F. F. & Burdekin, M., *Dynamic calibration of the positioning accuracy of machine tools and coordinate measuring machines using a laser interferometer*. Int. J. Mach. Tools Man., Vol. 43, No. 9, pp. 947-954, 2003.
32. Choi J. P., Minb B.K., Lee S. J., *Reduction of machining errors of a three-axis machine tools by on-machine measurement and error compensation system*, Journal of Materials Processing Technology, vol. 155-156, pp. 2056-2064, 2004.
33. Crăciun D., Stănășel I., Bungău C., Blaga F., Pancu R., Buidos T., *Research on accuracy of TMA-AL 550 horizontal processing centers*, Proceedings of the 11th International Conference MTeM, Cluj-Napoca, pp. 1-19, 2013.
34. Craciun D., Vesselenyi T., Bungau C., Ganea M., Buidos T., Blaga F., Stanasel I., *Design solution of rotary tilting table for five axes machining*, Annals of the Oradea University. Fascicle of Management and Technological Engineering, 2013.
35. Craciun D., Blaga F., Stanasel I., Bungau C., Ganea M., *Research regarding design and achievement of rotating tilting table for 5-axis machining*, Academic Journal Of Manufacturing Engineering, Vol. 11, pp. 60-63, ISSUE 3/2013.
36. De Donno, M., Litvin, F.L., *Computerized Design, Generation and Simulation of Meshing of a Spiroid Worm-Gear Drive with a Ground Double Crowned Worm*, Journal of Mechanical Design, Vol. 121, 1999.
37. Desa, G.; Kotha, S., *Ownership Mission and Environment: an Exploratory Analysis into the Evolution of a Technology Social Venture*, in *Social Entrepreneurship*, Mair, J., Robertson, J., Hockerts, K., Eds.; Palgrave Macmillan; New York, pp. 155–179, 2006.
38. Dean, T.; McMullen, J. *Toward a Theory of Sustainable Entrepreneurship: Reducing Environmental Degradation through Entrepreneurial Action*. *Journal of Business Venturing*, 22, pp. 50–76, 2007.
39. Di Pietro, G., *Do Study Abroad Programs Enhance the Employability of Graduates?* Discussion Paper No. 7675, Bonn: Institute for the Study of Labour, 2013.
40. Drayson, R.; Bone, E.; Agombar, J. *Student Attitudes towards and Skills for Sustainable Development. A Report for the Higher Education Academy*, Higher Education Academy: Heslington, York; pp. 33-34, 2012.
41. Elkington, J. *Cannibals with Forks. The Triple Bottom Line of 21st Century Business*, New Society Publishers: Stoney Creek CT, 1998.
42. Eric W. D., Sabi S., Dickson S. C., Christopher C. W., Andrew S. N., *Application of Lean Manufacturing Techniques in the Emergency department*, The Journal of Emergency Medicine, Vol. 37, No. 2, pp. 177–182, USA, 2009.
43. Epperly, R.A., Herberlin, G.E. and Eads, L.G., “*A tool for reliability and safety: predict and prevent equipment failure with thermography*”, IEEE App. Soc.Procs., pp. 59-68, 1997.
44. Evans, J., Finch, J., Toncar, M. F. and Reid, J. S., *Student Perceptions of and Preferences for a Short Overseas Study Tour*, Contemporary Issues in Education Research Vol. 1, 3 (11), 2008.
45. Fawaz A. A., Jayant R., *Analyzing the benefits of lean manufacturing and value stream mapping via simulation: A process sector case study*, Industrial and Management Systems Engineering Department, Kuwait University, Kuwait and Department of Industrial Engineering, University of Pittsburgh, Pittsburgh, PA 15261, USA, 2006.

46. Ferreira, P. M.; Liu, C. R., *A contribution to the analysis and compensations of the geometric error of a machining center*, // CIRP Annals-Manufacturing Technology, Vol. 35, pp. 259-262, 1986.
47. Fraser, S.; Greene, F., *The Effects of Experience on Entrepreneurial Optimism and Uncertainty*. Economica, Vol. 73, pp. 169–192, 2006.
48. Frangopol, Petre T., *Meritocrație și excelență. O radiografie a științei și învățământului în România*, Ed. Albatros, București, 2002.
49. Ganea, M., *Masini unelte flexibile si echipamente tehnologice pentru prelucrarea pieselor prismatice Vol. 2: Module si echipamente specifice celulelor si sistemelor flexibile. Calitatea si receptia masinilor unelte CNC*, Ed. Univ. din Oradea, 2010.
50. Ganea M., Bungau C., Vesselenyi T., *Possibilities of retrofitting at the horizontal milling centre TMA AL 550 to 5 axes machining and flexible cell functions*, Annals of the Oradea University. Fascicle of Management and Technological Engineering, 2008.
51. Ganea M., Ganea O., Bungau C., *Economic solutions at the rotary tilting table unit as 5 axes machining extensions at TMA-AL 550 machine*, Annals of the Oradea University. Fascicle of Management and Technological Engineering, 2009.
52. Ganea M., Ganea O., Horge I. - *Solutions for the 4-th axis “B” at the machine TMA AL 550*, Annals of the Oradea University. Fascicle of Management and Technological Engineering, 2008.
53. Ganea M., Bungău C., Pancu R., Moldovan O., *Constructive and technological objectives of the resources flow (working parts, tools, programs) at the flexible manufacturing cell TMA-AL-550*, Annals of the Oradea University. Fascicle of Management and Technological Engineering, Vol. IX (XIX), Nr.1, pp. 391-394, 2010.
54. Ganea, M., *Masini Unelte si Sisteme Flexibile*, Ed. Univ. din Oradea, 2010.
55. Gartner, W. “*Who is an Entrepreneur?*” *Is the Wrong Question*. American Journal of Small Business, Vol. 12, pp. 11–32, 1998.
56. Guyon, Patrick, *Pour unepolitique de l’esprit.Exercices pour l’ecole.*, Ed. Jerome Millon, Grenoble, pp. 116-124, 2008.
57. Gwen A. T, John H. Williams, *The impact of an accelerated improvement workshop on ordering and receiving*, Library Collections, Acquisitions, & Technical Services, Vol. 29, pp. 283–294, 2005.
58. Hsu Y,Y. and Wang, S.S., *A new compensation method for geometry errors of five-axis machine tools*, International Journal of Machine Tools & Manufacture, No. 47, pp. 352–360, 2007.
59. Hongyao, S., Jianzhong. F., Yong, H. and Xinhua, Y., *On-line Asynchronous Compensation Methods for static/quasi-static error implemented on CNC machine tools*, International Journal of Machine Tools & Manufacture, Vol. 60, pp. 14–26, 2012.
60. Hopwood, B.; Mellor, M.; O'Brien, G. *Sustainable Development: Mapping Different Approaches*. Sustainable Development, Vol. 13, pp. 38-52, 2005.
61. Illes Dudas, *The Theory and Practice of Worm Gear Drives*, ed. Kogan Page Science Paper, 2000.
62. Iwasawa K., Iwamaa A., Mitsui K., *Development of a measuring method for several types of programmed tool paths for NC machine tools using a laser displacement interferometer and rotary encoder*, Precision Engineering, Vol. 28, pp. 399-408, 2004.
63. Ibon S. L., Carlos O. L., Rodolfo de C. V., *An evaluation of the value stream mapping tool*, Business Process Management, Journal Vol. 14 No. 1, pp. 39-52, 2008.

64. Jennifer A. F., Eileen M. V. A., Toni L. D., June W., *Critical success factors for human resource outcomes in Kaizen events: An empirical study*, Int. J. Production Economics Vol. 117, pp. 42–65, 2009.
65. Jixiang, Y. and Yusuf, A., *Generalized kinematics of five-axis serial machines with non-singular tool path generation*, International Journal of Machine Tools & Manufacture, Vol. 75, pp. 119–132, 2013.
66. Kakino, Y., Ihara, Y., & Shinohara, A., *Accuracy Inspection of NC Machine Tools by Double Ball Bar Method*, Hanser Publisher, Munich, 1993.
67. Kakino, Y, Ihara Y, & Nakatsu, Y., *The measurement of motion errors of NC machine tools and diagnosis of their origins by using telescoping magnetic ball bar method*, Annals of CIRP, Vol. 36, No. 1, pp. 377-380, 1987.
68. Koren, J., *Computer Control of Manufacturing Systems*, 1st Edition, McGraw-Hill, Tokyo, 1983.
69. Kim J., D. Yang, “*Thermo-analysis of machining center main-axis thermo-displacement for infrared rays thermo-image camera*, ” Proceedings of the Korean Society of Machine Tool Engineers Conference, pp. 125-130, 2001.
70. King, R., Findlay, A. and Ahrens, *International student mobility literature review. Report to Higher Education Funding Council for England*, HEFCE, J., 2010.
71. Krapez J. C., Maldague X., Cielo P., “*Thermographic NonDestructive Evaluation: Data inversion procedures, Part II: 2-D Analysis and Experimental Results*,” *Research in Nondestructive Evaluation*, Vol. 3, pp. 101-124, 1991.
72. Krishnapillai, M., Jones, R., Marshall, I.H., Bannister, M. and Rajic, N.: *Thermography as a tool for damage assessment*, *Composite Structures*, Vol. 67, No. 2, pp. 149-155, 2005.
73. Kuckertz, A.; Wagner, M., *The influence of sustainability orientation on entrepreneurial intentions - Investigating the role of business experience*. *Journal of Business Venturing*, Vol. 25, pp. 524–539, 2010.
74. Lenox, M. *The role of private, decentralized institutions in sustaining industry self-regulation*. *Organization Science*, Vol. 17(6), pp. 670–690, 2006.
75. Lei, W.T. and Hsu, Y.Y., *Accuracy enhancement of five-axis CNC machines through real-time error compensation*, International Journal of Machine Tools & Manufacture, No. 43, pp. 871–877, 2003.
76. Li. Q., Liasi E, Simon D., Du R., “*Heating of industrial sewing machine needles: FEAmo del and verification using IR radiometry*,” in *Thermosense XXI*, Proc. SPIE, R.N. Wurzbach, D.D. Burleigh eds., 3700, pp. 347-357, 1999.
77. Lüthje, C.; Franke, N., *The ‘making’ of an entrepreneur: testing a model of entrepreneurial intent among engineering students at MIT*. *R & D Management*, Vol. 33(2), pp. 135–147, 2003.
78. Mair, J.; Robinson, J.; Hockerts, K. *Social Entrepreneurship*, Palgrave Macmillan: New York, 2006.
79. Maldague X., *Nondestructive evaluation of materials by infrared thermography*, London, Springer-Verlag, 1993 (new revised edition, *John Wiley & Sons Pub.*, exp. in 2001.
80. Meola, C., Carlomagno, G.M., Squillace, A. and Giorleo, G.: *The use of infrared thermography for nondestructive evaluation of joints*, *Infrared Physics & Technology*, Vol. 46, No. 1-2, pp. 93-99, 2004.

81. Mahmoud H., Bizhan J., *An extended model of design process of lean production systems by means of process variables*, Robotics and Computer-Integrated Manufacturing Vol. 22, pp. 1–16, 2006.
82. Matthias H., *The genealogy of lean production*, Journal of Operations Management Vol. 25, pp. 420–437, 2007.
83. Masaaki I., *Gemba Kaizen: A Commonsense, Low-Cost Approach to Management*, 1997.
84. Melton T., *The benefits of Lean Manufacturing what Lean Thinking has to offer the process industries*, Chemical Engineering Research and Design, Vol. 83(A6), pp. 662–673, 2005.
85. Mohsen, S., Behrooz, A. and Mohsen, H., *Dimensional and geometrical errors of three-axis CNC milling machines in a virtual machining system*, Computer-Aided Design, Vol. 45, pp. 1306–1313, 2013.
86. Montzeri, M., Van Wassenhove, L.N., “*Analysis of scheduling rules for an FMS*”, International Journal of Production Research, Vol. 28, nr. 4, pp. 785-802, 1990.
87. Murphy-Lejeune, E., *Student Mobility and Narrative in Europe. The new strangers*. London & New York: Routledge, 2002.
88. Ohno T., *Toyota Productivity System, Beyond Large-Scale Production*, Productivity Press, Cambridge, MA, 1988.
89. Okafor A.C. and Errekin Y.M., *Vertical machining center accuracy characterization using laser interferometer Part I. Linear positional errors*. Journal of Materials Processing Technology, Vol. 105, pp. 394-406, 2000.
90. Oliferuk, W. *Active thermovision in non-destructive testing of materials*, Proceedings of the XII Conference Non-destructive testing of materials Zakopane, pp. 10-25, 2006.
91. Pancu R., Ganea M., Bungau C., *Typical characteristics and functions at modular fixture system usable at pallet horizontal milling center and flexible cells*, Annals of the Oradea University. Fascicle of Management and Technological Engineering, 2009.
92. Pancu R., Bungau C., Ganea M., *Thermographic diagnosis at machine tools*, Revista de Tehnologii Neconventionale Vol. 17.2, pp. 62-66., 2013.
93. Peng, F.Y., Mab, J.Y., Wang, W., Duan, X. Y., Sun, P.P. and Yanb, R., *On-line Asynchronous Compensation Methods for static/quasi-static error implemented on CNC machine tools*, International Journal of Machine Tools & Manufacture, Vol. 60, pp. 14–26, 2012.
94. Pengcheng, H., Kai, T., Chen-Han, L., *Global obstacle avoidance and minimum workpiece setups in five-axis machining*, Computer-Aided Design, Vol. 45, pp. 1222–1237, 2013.
95. Poloszyk S., *Active thermovision in non-destructive testing*, Proceedings of the Conference Manufacturing’01, Vol. 2, pp. 221-228, 2001.
96. Preitl, Șt., Precup, E., “*Introducerea în conducerea fuzzy a proceselor*”, Editura Tehnică, București, 1997.
97. Praetzel, G. D. and Curcio, J., *Making Study Abroad a Reality for all Students*, International Advances in Economic Research, Vol. 2 (2), pp. 174-182, 1996.
98. Prahalad, C.; Hammond, A. *Serving the world's poor, profitably. Harvard Business Review*, Vol. 80 (9), pp. 48–57, 2002.
99. Prahalad, C. *The Fortune at the Bottom of the Pyramid: Eradicating Poverty through Profits*, The Wharton School: Philadelphia, PA, 2005.

100. Ramesh V., Sreenivasa P. K.V., Srinivas T.R., *Implementation of a Lean model for carrying out value stream mapping in a manufacturing industry*, Journal of Industrial and Systems Engineering Vol. 2, No. 3, pp. 180-196, 2008.
101. Ramesh, R. & Mannan, M. A., *Error compensation in machine tools - a review Part I: geometric, cutting force induced and fixture-dependent errors*. Int. J. Mach. Tools Man., Vol. 40, No. 9, pp. 1235-1256, 2000.
102. Rachna S., Peter T. W., *Defining and developing measures of lean production*, Journal of Operations Management Vol. 25, pp. 785–805, 2007.
103. Redonnet, J., Rubio M. W., Monies F., Dessein G., *Optimising Tool Positioning for End-Mill Machining of Free-Form Surfaces on 5-Axis Machines for both Semi-Finishing and Finishing*, Int J Adv Manuf Technol, Vol. 16, pp. 383–391, Springer, 2000.
104. Richard J. S., *Japanese production management: An evolution—With mixed success*, Journal of Operations Management, Volume 25, Issue 2, pp. 403-419, SUA, 2007.
105. René J. B., *Adapting lean to histology laboratories*, Annals of Diagnostic Pathology Vol. 13, pp. 322–333, 2009.
106. Rumberger, Russell W., *Why Students Drop Out of School and What Can Be Done. UCLA: The Civil Rights Project/ProyectoDerechosCiviles. Retrieved from: <https://escholarship.org/uc/item/58p2c3wp>*, pp. 9, 2001.
107. Schlesinger G., *Testing Machine tools – The Industrial Press*, New York, 1945.
108. Sakagami, Takahide. *Recent Progress in Nondestructive Evaluation Techniques Using Infrared Thermography*. Hihakaikensa, Vol. 51, No. 6, pp. 321–327, 2002.
109. Soichi, I., Kakino, Y., Akai, T., Takayama, N., Yamaji, I. and Ogawa, K., *Measurement of Error motions on Five-axis Machine Tools by Ball Bar Tests*, Journal of SME-Japan, 2012.
110. Sofron, E ș.a., “*Sisteme de control fuzzy- Modelare și proiectare asistate de calculator*”, Editura, All, București, 1998.
111. Stephen L. W., Louay A. S., *Using Dynamic Value Stream Mapping and Lean Accounting Box Scores to Support Lean Implementation*, EABR & ETLC Conference Proceedings Dublin, Ireland, 2010.
112. Stead, W.E.; Stead, J.G. *Can humankind change the economic myth? Paradigm shifts necessary for ecologically sustainable business*. Journal of Organizational Change Management, Vol. 7(4), pp. 15-31, 1994.
113. Shane, S.; Venkataraman, S. *The promise of entrepreneurship as a field of research*. Academy of Management Review, Vol. 25(1), pp. 217–226, 2000.
114. Schaper, M. *Making Ecopreneurs: Developing Sustainable Entrepreneurship*, Ashgate: Aldershot, U.K., 2005.
115. Staber, U., *An Ecological Perspective on Entrepreneurship in Industrial Districts*, Entrepreneurship and Regional Development, Vol 24(1), pp. 37–48, 1997.
116. Souitaris, V.; Zerbinati, S.; Al-Laham, A., *Do entrepreneurship programmes raise entrepreneurial intention of science and engineering students? The effect of learning, inspiration and resources*. Journal of Business Venturing, Vol. 22, pp. 566-591, 2007.
117. Shane, S., *Prior Knowledge and the Discovery of Entrepreneurial Opportunities*, Organization Science, Vol. 11(4), pp. 448–469, 2000.
118. Smith, A., *One Step Beyond: Making the most of Postgraduate Education*, Department for Business Innovation and Skills, pp. 43, 2010.

119. Tyson R. B., Ralph D. H., *Reconceptualizing the effects of lean on production costs with evidence from the F-22 program*, Journal of Operations Management Vol. 27, pp. 23–44, 2009.
120. Tsutsumi, M., Tone. S., Kato, N. and Sato, R., *Enhancement of geometric accuracy of five-axis machining centers based on identification and compensation of geometric deviations*, International Journal of Machine Tools & Manufacture, Vol. 68, pp. 11–20, 2013.
121. Thomas, R., *“The continued and future use of infrared use of infrared thermography”*, Proceeding of 2nd WCEAM, pp. 1897-1907, 2007.
122. Toncar, M. F. and Reid, J. S., *Study Abroad: Business Student Perceptions and Preferences*. In: R. J. Bauerly, P. C. Thistlethwaite and D. W. Schofield, eds. Proceedings, Emerging Issues in Business and Technology. South Carolina: Myrtle Beach, 2004.
123. Utpal R., Cargian M., Dunstall S., Wirth A., Warkentin A., Hoskins P., *Systems Techniques and Computational Methods*, ed. Cornelius Leondes, 2001.
124. Walley E.; Taylor, D., *Opportunists, Champions, Mavericks? A Typology of Green Entrepreneurs*, Greener Management International, Vol. 38, pp. 31–35, 2000.
125. Zahra, S.; Gedajlovic, E.; Neubaum, D.; Shulman, J., *A Typology of Social Entrepreneurs: Motives, Search Processes and Ethical Challenges*, Journal of Business Venturing, Vol. 24(6), pp. 519–532, 2009.
126. Zhang, K., Yuen, A. and Yusuf, A., *Pre-compensation of contour errors in five-axis CNC machine tools*, International Journal of Machine Tools & Manufacture, Vol. 74, pp. 1–11, 2013.
127. *** <http://resources.renishaw.com/en/download/brochure-xl-80-laser-system--36870>.
128. *** <http://www.renishaw.com/en/measurement-optics-for-xl-80--8427>.
129. *** www.renishaw.com.
130. *** www.flir.com/cs/emea/en/view/?id=41965.
131. *** www.flir.com/uploadedFiles/Thermography/MMC/Brochures/T820483/T820483_EN.pdf.
132. *** www.flir.com/uploadedFiles/Thermography/MMC/Brochures/T820147/T820147_APAC.pdf.
133. *** www.intelbuild.eu/en/laboratory/oradea/technical-resource.
134. *** www.micronix.ro.
135. *** www.stimin.ro.
136. *** *Henschel Antriebstechnik-Mutax-Duplex- Worm Gear Sets Schneckenradsätze Couples à vis sans fin*- <http://www.henschel.eu/data/MUTAX-DUPLEX.pdf>.
137. *** *Quality Transmission Components- Catalog Q410* <http://www.qtcgears.com/Q410/Q410Cat.html>.
138. *** *CNC rotarY tables for Mori seiki vertical machining centers, duravertikal, NV, VS, and MV series*- [HTTP://WWW.LINDEXNIKKEN.COM/](http://WWW.LINDEXNIKKEN.COM/).
139. *** *Haas CNC Rotaries and Indexers - Haas Automation, Inc*- [HTTP://WWW.HAASCNC.COM/](http://WWW.HAASCNC.COM/)
140. *** *GSA-Product CNC TILTING Rotary Table*- [HTTP://WWW.GSAPLUS.COM](http://WWW.GSAPLUS.COM).
141. *** *CNC Tilting Rotary Table | CNC Trunnion Tables*- [HTTP://WWW.CNCINDEXING.COM](http://WWW.CNCINDEXING.COM).
142. *** *GFTE-794-EN_02_LargeMotor(Spec)_v02- AC Servo motor ais series-AC Spindle amplifier ai series- 2008 Fanuc GE CNC Europe S.A.*
143. *** *Gates synchronous belts catalog*- [HTTP://WWW.GATES.COM/](http://WWW.GATES.COM/).

144. *** NAS 979:1969, *Uniform Cutting Tests - NAS Series Metal Cutting Specification*. Aerospace Industries Association of America, Inc. 1969.
145. *** *Renishaw QC20-W Wireless Ballbar System Description and Specifications*, Issued 1211 L-8014-1588-04-A, 2011.
146. *** *MatlabWork 12*.
147. ***<http://citynews.ro/interviu/sociologul-paul-haragus-sistemul-de-invatamant-dominat-de-inegalitati>.
148. ***<http://epp.eurostat.ec.europa.eu/tgm/table.do?tab=table&plugin=1&language=fr&pcod=tps00062> accessed 17.03.2014.
149. ***<http://epp.eurostat.ec.europa.eu/tgm/table.do?tab=table&init=1&language=fr&pcod=tsdsc510&plugin=1> accessed 17.03 2014.
150. ***<http://epp.eurostat.ec.europa.eu/tgm/table.do?tab=table&init=1&language=fr&pcod=tsdsc410&plugin=1> accessed 18.03 2014.
151. ***<https://www.uoradea.ro/display530>.
152. ***<https://www.uoradea.ro/display530>, p. 80.
153. ***www.cier.amier.org.
154. ***www.amier.org.
155. ***<http://ec.europa.eu/research/participants/portal/desktop/en/home.html>.
156. ***http://www.goleansixsigma.com/wp-content/uploads/2012/02/The-Basics-of-Lean-Six-Sigma-www.GoLeanSixSigma.com_.pdf.
157. ***http://ec.europa.eu/enterprise/sectors/ict/files/kets/6_advanced_manufacturing_report_en.pdf.
158. ***DMG, [www.dmg.com/query/internet/v3/pdl.nsf/5474714afc475f31c12572410038e836/\\$file/pm6us09_hsc-linear-series.pdf](http://www.dmg.com/query/internet/v3/pdl.nsf/5474714afc475f31c12572410038e836/$file/pm6us09_hsc-linear-series.pdf)
159. ***Huron, www.huron.fr/upload/343172557KX%20Five%20Series%20-%20English%20-%202010%2006.pdf
160. ***IOM, *World Migration 2008*, Geneva: IOM, 2008.
161. ***ISO 230-2:2006: *Test code for machine tools -- Part 2: Determination of accuracy and repeatability of positioning numerically controlled axes*. International Organization for Standardization, 2006.
162. ***ISO 3070-3 *Test conditions for boring and milling machines with horizontal spindle - Testing of the accuracy - Part 3: Floor type machines with detached, stationary work-holding table*.
163. ***ISO10791-1:1998 *Test conditions for machining centres -- Part 1: Geometric tests for machines with horizontal spindle and with accessory heads (horizontal Z-axis)*.
164. ***ISO 18434-1:2008 – *Condition monitoring and diagnostics of machines — Thermography — Part 1: General procedures*.
165. ***OECD, *Trends in International Migration*, Paris: OECD/SOPEMI, 2001.
166. ***Renishaw help, *Ballbar QC20 W*, 2013.
167. ***Rotary-table, <http://www.rotary-table-2.com/product-21.htm> (accessed in 2013)
168. ****Statistical testing of the operational and positional accuracy of machine tools*, VDI/DGQ 3441.
169. ***Troyke, www.troyke.com, (accessed in 2013)
170. ***TMA AL 550, *Instruction Manual*, Italy, 1996.
171. ***UNESCO, *Education for Sustainable Development: An Expert Review of Processes and Learning*, Division of Education for Peace and Sustainable Development: Paris, 2011.

172. ***Yukiwa, www.primatigon.com/Products/Yukiwa/pro3a3.htm (accessed in 2013)
173. ***World Commission on Environment and Development. *Our Common Future*, Oxford University Press: Oxford, 1987.
174. *** Applications Plexus corp.

Nota:

1. Potrivit art. 300 alin. (2) din Legea educației naționale nr. 1/2011, „Teza de abilitare relevă capacitățile și performanțele didactice și de cercetare. Teza prezintă în mod documentat realizările profesionale obținute ulterior conferirii titlului de doctor în știință, care probează originalitatea și relevanța contribuțiilor academice, științifice și profesionale și care anticipează o dezvoltare independentă a viitoarei cariere de cercetare și/sau universitare”.

2. Prezenta teza s-a redactat în baza prevederilor din „Ghid orientativ pentru realizarea tezei de abilitare” elaborat de CONSILIUL NAȚIONAL DE ATESTARE A TITLURILOR, DIPLOMELOR ȘI CERTIFICATELOR UNIVERSITARE