

Spring 2017

# Analysis of Project Management System Structure Using the Viable System Model (VSM)

Joseph A. Sisti  
*Old Dominion University*

Follow this and additional works at: [https://digitalcommons.odu.edu/emse\\_etds](https://digitalcommons.odu.edu/emse_etds)



Part of the [Management Information Systems Commons](#), and the [Systems Engineering Commons](#)

---

## Recommended Citation

Sisti, Joseph A.. "Analysis of Project Management System Structure Using the Viable System Model (VSM)" (2017). Doctor of Philosophy (PhD), dissertation, Engineering Management, Old Dominion University, DOI: 10.25777/mw8g-5f36  
[https://digitalcommons.odu.edu/emse\\_etds/15](https://digitalcommons.odu.edu/emse_etds/15)

This Dissertation is brought to you for free and open access by the Engineering Management & Systems Engineering at ODU Digital Commons. It has been accepted for inclusion in Engineering Management & Systems Engineering Theses & Dissertations by an authorized administrator of ODU Digital Commons. For more information, please contact [digitalcommons@odu.edu](mailto:digitalcommons@odu.edu).

ANALYSIS OF PROJECT MANAGEMENT SYSTEM STRUCTURE USING THE  
VIABLE SYSTEM MODEL (VSM)

by

Joseph A. Sisti

B.S.E.E. June 1988, Old Dominion University  
M.E.M. December 2002, Old Dominion University

A Dissertation Submitted to the Faculty of  
Old Dominion University in Partial Fulfillment of the  
Requirement for the Degree of

DOCTOR OF PHILOSOPHY

ENGINEERING MANAGEMENT

OLD DOMINION UNIVERSITY

March 2017

Approved by:

Charles B. Keating (Director)

Rafael Landaeta (Member)

Pilar Pazos (Member)

James C. Pyne (Member)

© Copyright by Joseph A. Sisti 2017  
All Rights Reserved

## ABSTRACT

### ANALYSIS OF PROJECT MANAGEMENT SYSTEM STRUCTURE USING THE VIABLE SYSTEM MODEL (VSM)

Joseph A. Sisti  
Old Dominion University, 2017  
Director: Dr. Charles B. Keating

The purpose of this research was to explore the applicability of the Viable System Model as a framework for structural analysis of Project Management Systems using a case study approach. The research used a modified Viable System Model based on the work of Stafford Beer (1979) for the analysis of systems (organizations). The specific research questions explored in this research were: (1) How can the Viable System Model (VSM) be adapted for analysis of project management structure? And, (2) What results from exploration of the Viable System Model framework application to active project management structures?

The research used an exploratory case study method (Yin 2009) to explore the research questions. The research was designed as a multiple case study of two projects within a government based engineering services enterprise. The research, including data collection, analysis, and reporting was accommodated by a government based engineering group to support research aims related to studying Project Management Systems.

A modified Viable Systems Model (VSM) framework based on management cybernetics of Stafford Beer (1966, 1981, 1979, 1985, and 1994) was developed for application to project management system structure. Following construction of the VSM framework, adapted for project management systems, qualitative data was collected in the form of discussions, meetings,

process documents, project documents, and observation notes. The collected data was incorporated into a case study database. The case study database was used to extrapolate emergent themes and issues needed for the development of the case study narratives. The construction of the emergent themes and issues followed the coding regimen from grounded theory (Corbin & Strauss, 2008). A case study narrative was produced for each of the two case studies and project participants were provided a copy for face validation (content and accurate capture of perspectives) from which the final narratives were constructed. The reviewed case study narratives were then incorporated into the final case study narratives. A cross case analysis, between the two focal projects, was performed. The research conclusions and implications were reported and implications for further research were developed in the results sections.

This work is dedicated to my parents Joseph J. & Anna L. Sisti who knew this day would come and encouraged me greatly even now as they watch down from heaven. To my sister Carol, for being the best big sister a younger brother could have. To my uncle, Elton Horne, who introduced me to electricity and sparked my interest in engineering from an early age. To my 'favorite' and only daughter Trinity, I remind her that all things are possible and never give up on your dreams: Life is a Journey, not just a Destination, at any age!

## ACKNOWLEDGMENTS

A message to some important people without whom this research could never have been completed. My sincere thanks to Chuck Keating who helped guide me from the first day I walked in his door and asked “what next?” (Once my course work was completed). Chuck has been the greatest inspiration to my research efforts and has become a true friend in the process. As my advisor, he has inspired this research journey and sparked my interest in Stafford Beer’s VSM. I would like to also thank my committee members: Rafael Landaeta, Pilar Pazos, and James Pyne. Their willingness to invest their time and inspiration into my research effort will forever be appreciated. I would like to thank the faculty and staff of ODU’s Department of Engineering Management for their support and for an academic program that allowed me to pursue meaningful research within the engineering management domain.

My thanks to my SPAWAR Atlantic family, especially to the following: To Robert White (retired), for introducing me to Satellite Communications and project management; for being a great mentor and honest friend. To Ray Chappell, Arnel Castillo, Charlie Adams, Marvin Johnson, James Farley, Tommy Thompson (retired), Pam Hawver and many others for being supportive of this academic journey and keeping me focused over the years.

And finally, thanks to all the project participants who participated in this research effort and took the time to review the case narratives.

## TABLE OF CONTENTS

LIST OF TABLES .....	ix
LIST OF FIGURES .....	xiii
ABSTRACT .....	i
INTRODUCTION .....	1
BACKGROUND.....	1
PURPOSE OF STUDY .....	2
RESEARCH QUESTIONS.....	3
STUDY LIMITATIONS AND DELIMITATIONS .....	4
RESEARCH SIGNIFICANCE .....	7
DOCUMENT ORGANIZATION.....	9
LITERATURE REVIEW .....	13
INTRODUCTION.....	13
PROJECT MANAGEMENT SYSTEMS (PMS) .....	15
PMS: PMBOK PERSPECTIVE.....	24
CYBERNETICS: PRELUDE TO THE VSM.....	33
VIABLE SYSTEM MODEL (VSM).....	38
ORIGINS OF THE VSM .....	43
CRITICISM OF THE VSM .....	58
APPLICATION AREAS OF THE VSM .....	59
SYSTEM ONE.....	62
SYSTEM TWO.....	64
SYSTEM THREE .....	67
SYSTEM THREE * (STAR) .....	70
SYSTEM FOUR .....	71
SYSTEM FIVE .....	75
SYSTEM INTERACTIONS WITHIN THE VSM.....	77
CHANNELS IN THE VSM.....	80
ADAPTING THE VSM MODEL.....	84
SUMMARY .....	85
RESEARCH METHODOLOGY.....	86
INTRODUCTION.....	86
QUALITATIVE - QUANTITATIVE HISTORICAL DISTINCTION .....	86
CASE STUDY RESEARCH AS A QUALITATIVE METHOD .....	89
CASE STUDY RESEARCH .....	92
COMPONENTS OF RESEARCH DESIGN .....	99
CASE STUDY DESIGNS .....	107
PREPARING TO COLLECT CASE STUDY EVIDENCE.....	112
CASE STUDY RESEARCHER SKILLS .....	113



PREPARATION AND TRAINING FOR A CASE STUDY .....	116
THE CASE STUDY PROTOCOL .....	117
COLLECTING CASE STUDY EVIDENCE .....	121
SUMMARY .....	127
RESEARCH DESIGN .....	129
INTRODUCTION.....	129
PHASE I OF THE RESEARCH DESIGN: FRAMEWORK DEVELOPMENT.....	130
FRAMEWORK DEVELOPMENT .....	131
SYSTEM ONE.....	134
SYSTEM TWO.....	136
SYSTEM THREE .....	138
SYSTEM THREE * (STAR) .....	142
SYSTEM FOUR .....	143
SYSTEM FIVE .....	145
VSM SIX PRIMARY COMMUNICATION CHANNELS .....	146
DATA ANALYSIS USING THE MODIFIED VSM.....	150
PHASE II OF THE RESEARCH DESIGN: CASE STUDY DEVELOPMENT PHASE .....	151
SELECTION OF CASE STUDIES USED FOR ANALYSIS .....	154
DATA COLLECTION STRATEGIES.....	156
ROLE OF THE RESEARCHER.....	160
CASE STUDY RESEARCHER SKILLS .....	162
TIME BOUNDARIES .....	165
STAKEHOLDER ISSUES .....	166
METHOD OF ACHIEVING VALIDITY AND RELIABILITY .....	167
APPROPRIATENESS OF THE DATA .....	169
RELATIONSHIP OF THE DATA TO THE CASE STUDY OBJECTIVE .....	169
CASE STUDY DATABASE CONSTRUCTION .....	170
CASE NARRATIVE CONSTRUCTION.....	171
CASE VALIDATION AND VERIFICATION .....	172
CROSS CASE ANALYSIS .....	173
SUMMARY .....	173
FRAMEWORK ANALYSIS FINDINGS .....	175
INTRODUCTION.....	175
VSM TO PMBOK PMS MATRIX ANALYSIS FINDINGS .....	175
SUMMARY .....	179
PROJECT Q: A CASE STUDY .....	180
INTRODUCTION.....	180
BACKGROUND.....	180
SYSTEM ONE DEVELOPMENT FROM THE CSR DATABASE .....	188
SYSTEM TWO DEVELOPMENT FROM THE CSR DATABASE .....	191
SYSTEM THREE AND THREE* (STAR) DEVELOPMENT .....	193
SYSTEM FOUR DEVELOPMENT FROM THE CSR DATABASE.....	197

SYSTEM FIVE DEVELOPMENT FROM THE CSR DATABASE.....	199
CHANNEL DEVELOPMENT FROM THE CSR DATABASE .....	201
CHANNEL ONE DEVELOPMENT FROM THE CSR DATABASE .....	204
CHANNEL TWO DEVELOPMENT FROM THE CSR DATABASE .....	205
CHANNEL THREE DEVELOPMENT FROM THE CSR DATABASE .....	206
CHANNEL FOUR DEVELOPMENT FROM THE CSR DATABASE.....	207
CHANNEL FIVE DEVELOPMENT FROM THE CSR DATABASE .....	207
CHANNEL SIX DEVELOPMENT FROM THE CSR DATABASE.....	208
CHANNEL ALGEDONIC DEVELOPMENT FROM THE CSR DATABASE.....	209
PROJECT ‘Q’ CASE STUDY SUMMARY .....	212
PROJECT ‘Q’ CASE STUDY CONCLUSION .....	214
PROJECT T: A CASE STUDY.....	216
INTRODUCTION.....	216
BACKGROUND.....	216
SYSTEM ONE DEVELOPMENT FROM THE CSR DATABASE .....	222
SYSTEM TWO DEVELOPMENT FROM THE CSR DATABASE .....	224
SYSTEM THREE AND THREE* (STAR) DEVELOPMENT .....	226
SYSTEM FOUR DEVELOPMENT FROM THE CSR DATABASE.....	230
SYSTEM FIVE DEVELOPMENT FROM THE CSR DATABASE.....	233
CHANNEL DEVELOPMENT FROM THE CSR DATABASE .....	236
CHANNEL ONE DEVELOPMENT FROM THE CSR DATABASE .....	239
CHANNEL TWO DEVELOPMENT FROM THE CSR DATABASE .....	240
CHANNEL THREE DEVELOPMENT FROM THE CSR DATABASE .....	243
CHANNEL FOUR DEVELOPMENT FROM THE CSR DATABASE.....	245
CHANNEL FIVE DEVELOPMENT FROM THE CSR DATABASE .....	247
CHANNEL SIX DEVELOPMENT FROM THE CSR DATABASE.....	249
CHANNEL ALGEDONIC DEVELOPMENT FROM THE CSR DATABASE.....	251
PROJECT ‘T’ CASE STUDY SUMMARY.....	251
PROJECT ‘T’ CASE STUDY CONCLUSION.....	254
CROSS CASE ANALYSIS.....	256
INTRODUCTION.....	256
SYSTEM ONE – CROSS CASE REVIEW .....	257
SYSTEM TWO – CROSS CASE REVIEW.....	260
SYSTEM THREE – CROSS CASE REVIEW .....	261
SYSTEM THREE * (STAR) – CROSS CASE REVIEW .....	264
SYSTEM FOUR – CROSS CASE REVIEW .....	266
SYSTEM FIVE – CROSS CASE REVIEW .....	267
CHANNEL ONE – CROSS CASE REVIEW .....	269
CHANNEL TWO – CROSS CASE REVIEW .....	271
CHANNEL THREE – CROSS CASE REVIEW .....	272
CHANNEL FOUR – CROSS CASE REVIEW .....	275
CHANNEL FIVE – CROSS CASE REVIEW .....	277
CHANNEL SIX – CROSS CASE REVIEW .....	278

ALGEDONIC CHANNEL – CROSS CASE REVIEW .....	280
SUMMARY .....	282
CONCLUSION.....	283
INTRODUCTION.....	283
THEORY IMPLICATIONS .....	283
METHODOLOGY CONTRIBUTIONS.....	288
PRACTICAL CONTRIBUTIONS .....	291
SUMMARY .....	297
REFERENCES .....	301
APPENDIX.....	305
PROJECT ‘Q’: CASE STUDY REVIEW DRAFT .....	305
PROJECT ‘T’: CASE STUDY REVIEW DRAFT.....	320
POTENTIAL DISCUSSION QUESTIONS .....	361
PROJECT ‘Q’: CASE STUDY FEEDBACK.....	363
PROJECT ‘T’: CASE STUDY FEEDBACK .....	364
ACRONYMS .....	365
GLOSSARY OF TERMS .....	366
VMS TO PMBOK PMS ANALYSIS MATRIXES DATA .....	370
CASE STUDY DATABASE EXCERPT AND SOURCE CODING .....	378
VITA.....	380

## LIST OF TABLES

Table	Page
1. Significant Contributions of this Research.....	9
2. Literature Review for Project Management Systems.....	17
3. PM Process Group and Knowledge Area Mapping {Adapted from PMBOK, 2013} .....	31
4. Research Design Components {Adapted from (Yin, 2009, pp. 35-36)}.....	91
5. Data Element Sources and Problem Areas to Consider (Yin, 2009).....	95
6. Design verses Data Collected.....	120
7. Strengths and Weaknesses {Adapted from (Yin, 2009, p. 102)}.....	123
8. System One Identifiers .....	135
9. System Two Identifiers .....	137
10. System Three Identifiers .....	140
11. System Three* (Star) Identifiers .....	142
12. System Four Identifiers .....	144
13. System Five Identifiers.....	146
14. Channel One Identifiers.....	147
15. Channel Two Identifiers .....	147
16. Channel Three Identifiers.....	148
17. Channel Four Identifiers.....	148
18. Channel Five Identifiers .....	148
19. Channel Six Identifiers .....	149
20. Algedonic Channel .....	149

21. Sources of Evidence .....	159
22. Excerpt from the Bibliography of the Data Sources .....	182
23. Evidence Data with Matrix Analysis with Identifiers (Portion).....	184
24. S1 System Description .....	185
25. S1 Definition/Identifiers .....	189
26. Evidence Items for S1 .....	190
27. S2 Definitions/ Identifiers .....	191
28. S2 Case Study Evidence Items (Portion) .....	192
29. S3 Definition/Identifiers .....	194
30. S3* (Star) Definitions/Identifiers .....	195
31. S3 Evidence Item Descriptions (Portions) .....	195
32. S3* (Star) Evidence Items (Portion) .....	196
33. S4 Definition/Identifiers .....	198
34. S4 Evidence Items (Portion).....	199
35. S5 Definition/Identifiers .....	200
36. S5 Evidence Items (Portion).....	201
37. C1 Evidence Items (Portion) .....	204
38. C2 Evidence Item (Portion).....	205
39. C3 Evidence Items (Portion) .....	206
40. C4 Evidence Item (Portion).....	207
41. C5 Evidence Item (Portion).....	208
42. C6 Evidence Item (Portion).....	209

43. Bibliography of Data Sources and Dates Received.....	218
44. S1 System Description .....	220
45. S1 Definition/Identifiers.....	223
46. S1 Evidence Item (Portion) from Case Study Database.....	223
47. S2 Definitions/ Identifiers .....	225
48. S3 Definition/Identifiers.....	228
49. S3* (Star) Definitions/Identifiers .....	229
50. Evidence Items for S3 and S3* (Star) (Portion) from the Case Study Database .....	230
51. S4 Definition/Identifiers.....	232
52. S4 Evidence Item (portion) from the Case Study Database .....	233
53. S5 Definition/Identifiers.....	235
54. S5 Evidence Item (portion) from the Case Study Database .....	236
55. C1 Evidence Items from Case Study Database (Portion).....	240
56. C2 Evidence Items from the Case Study Database (Portion).....	242
57. C3 Evidence Items from the Case Study Database (Portion).....	244
58. C4 Evidence from the Case Study Database (Portion).....	247
59. Evidence from the Case Study Database (Portion) .....	248
60. C6 Evidence from Case Study Database (Portion) .....	250
61. System One Similarities and Differences Summarized .....	259
62. Significant Contributions of this Research Study .....	298
63. Areas for Future Research.....	299
64. Chapter 2 VMS to PMBOK PMS Analysis Matrix .....	371

65. Chapter 3 VSM to PMBOK PMS Analysis Matrix .....	371
66. Chapter 4 VSM to PMBOLK PMS Analysis Matrix .....	372
67. Chapter 5 VSM to PMBOK PMS Analysis Matrix .....	372
68. Chapter 6 VSM to PMBOK PMS Analysis Matrix .....	373
69. Chapter 7 VSM to PMBOK PMS Analysis Matrix .....	373
70. Chapter 8 VSM to PMBOK PMS Analysis Matrix .....	374
71. Chapter 9 VSM to PMBOK PMS Analysis Matrix .....	374
72. Chapter 9 VSM to PMBOK PMS Analysis Matrix .....	375
73. Chapter 11 VSM to PMBOK PMS Analysis Matrix .....	375
74. Chapter 12 VSM to PMBOK PMS Analysis Matrix .....	376
75. Chapter 13 VSM to PMBOK PMS Analysis Matrix .....	376
76. VSM to PMBOK PMS Analysis Matrixes Summations.....	377
77. Case Study Database Excerpt.....	378

## LIST OF FIGURES

Figure	Page
1. Structure for the Inquiry .....	3
2. Dissertation Chapter Organization .....	10
3. Literature Review Process .....	14
4. System Development Cycle {Adapted from Nicholas and Steyn (2008, p. 119)} .....	18
5. A Model of a Project {Adapted from Leavitt's Diamond, (Scott, 1998, p. 17)} .....	19
6. Viable System Model {Adapted from Ríos, 2012, p. 49} .....	40
7. VSM with Operational Units Noted {Adapted from Ríos, 2012, p. 26} .....	63
8. System Two (S2) {Adapted from Beer, 1981, p. 173} .....	67
9. VSM Highlighting Systems 3, 3* (Star), 4, and 5 {Adapted from Ríos, 2012, p. 26} .....	69
10. VSM Showing System Five {Adapted From Ríos, 2012, p. 60} .....	76
11. VSM Six Primary Channels {Adapted from Ríos, 2012, p. 61} .....	83
12. Convergence of Evidence: Single Case Study {Adapted from (Yin, 2009, p. 117)} .....	94
13. Maintaining a Chain of Evidence {Adapted from (Yin, 2009, p. 123)} .....	96
14. Data Analysis in Qualitative Research {Adapted from (Creswell, 2009, p. 185)} .....	98
15. Making Inferences {Adapted from (Yin, 2009, p. 39)} .....	103
16. Case Study Method {Adapted from (Yin, 2009, p. 57)} .....	111
17. Research Design .....	130
18. VSM System-in-Focus {Adapted From Ríos, 2012, p. 130} .....	134
19. VSM System One {Adapted From Ríos, 2012, p. 29} .....	136
20. VSM System Two {Adapted From Beer, 1981, p. 173} .....	138



Figure	Page
21. VSM with Systems Identified {Adapted From Ríos, 2012, p. 107} .....	141
22. Research Design .....	152
23. Case Study Narrative Procedure.....	172
24. Preliminary VSM Diagram for a Project.....	187
25. The Six Primary Communication Channels of the VSM .....	202
26. Evidence #18 Team Communication Examples .....	203
27. VSM of Project (Systems and Channels are Described in the Preceding Narrative).....	211
28. VSM of Project (Systems and Channels are Described in the Case Narrative) .....	213
29. Preliminary VSM Diagram for a Project.....	221
30. The Six Primary Communication Channels of the VSM .....	238
31. VSM of Project (Systems and Channels are Described in the Case Narrative) .....	253
32. VSM Diagram for a Project.....	309
33. The Six Primary Communication Channels of the VSM.....	314
34. Evidence #18 Team Communication Example .....	315
35. VSM of Project where the functional components are described in the narrative .....	319
36. Preliminary VSM Diagram for a Project.....	329
37. The Six Primary Communication Channels of the VSM .....	345
38. VSM of Project (Systems and Channels are Described in the Case Narrative) .....	360

## INTRODUCTION

This section describes the background and purpose of this research. This research was to explore the applicability of the Viable System Model as a framework for structural analysis of Project Management Systems using a case study approach. The research used a modified Viable System Model based on the work of Stafford Beer (1979) for the analysis of systems (organizations). The research questions explored in this research were: (1) How can the Viable System Model (VSM) be adapted for analysis of project management structure? And; (2) What results from exploration of the Viable System Model framework application to active project management structures? The research's limitations and delimitations are introduced and the significance of the research is presented in this chapter. The chapter ends with a discussion of the organization of this document.

## BACKGROUND

Project managers within project based organizations continue to work within the context of their organization, project, and environment in providing leadership and direction to project teams. This research explored the use of the Viable Systems Model (VSM) in analyzing the Project Management Structure (PMS) of a project team through the use of case study research. This rigorous qualitative research approach explored a new perspective of project structures previously unused in the project management literature.

The Viable System Model by Stafford Beer was presented most notably in *Brain of the Firm* (Beer, 1981) and *Heart of the Enterprise* (Beer, 1979). Beer described the VSM and the underlying theoretical basis for its development throughout each of these texts. The Viable

System Model (VSM) is believed to be adaptable for the analysis of project management structures using case study research. Yin (2009) notes that the use of case studies are an effective research approach when a “rigorous methodological path” is followed.

## **PURPOSE OF STUDY**

The purpose of this research was to explore the applicability of the Viable System Model (VSM) as a framework for structural analysis of project management systems using a case study research design.

Today’s body of knowledge for complex project-based organizations often focuses on its project management systems and the organization uses projects to achieve their strategic business outcomes (PMBOK, 2013). The Viable System Model (VSM), developed by Stafford Beer, was traditionally used to analyze an organization from a perspective that differed from the mainstream of the time. The VSM looked at structure not from a hierarchical view but rather the functional interaction of the individual systems and how they interacted iteratively. This research bridges the gap between the systems-based analyses of a project based organization and the analysis of its project management structure by using the VSM as a diagnostic analysis model for examination of viability. This research used the case study method as a rigorous methodology capable of supporting the aims of the research. The structure for inquiry can be seen in Figure 1 below:

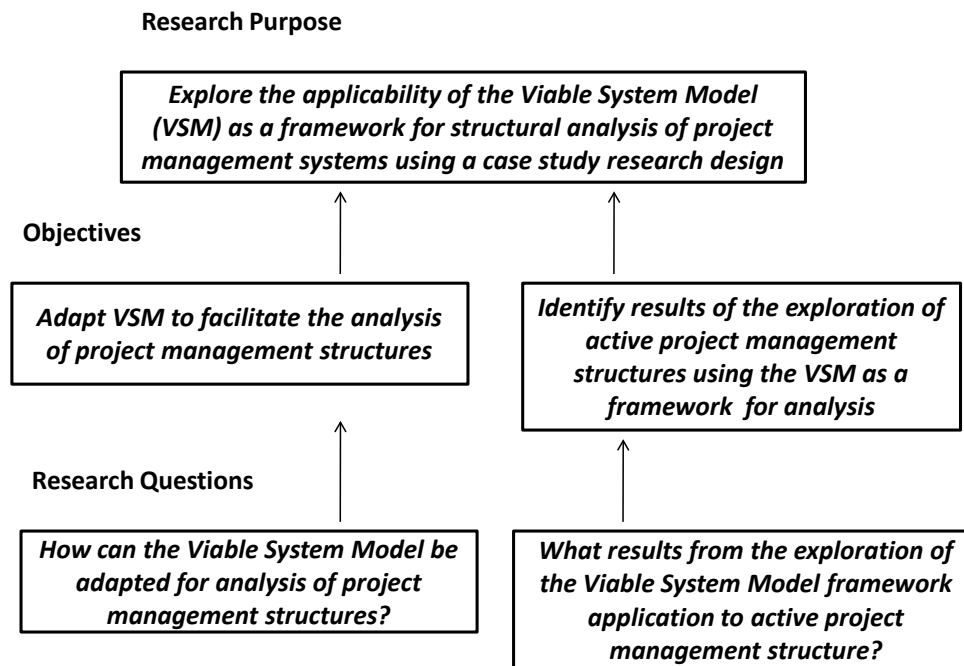

**Figure 1: Structure for the Inquiry**

## RESEARCH QUESTIONS

QUESTION 1: How can the Viable System Model (VSM) be adapted for analysis of project management structure?

Additional perspectives for analyzing project management structures can help to provide theoretical results which will add to the body of knowledge. The application of the VSM to project management structure has been scarcely developed in the literature (see Literature Review). Also, using the case study method as a research design approach offers researchers a rigorous methodology to analyzing project management structures. This methodology has not

been a dominant research approach in the engineering management or systems engineering fields.

QUESTION 2: What results from exploration of the Viable System Model framework application to active project management structures?

Through the use of the Viable System Model, research using the case study research method targeted results that would not have otherwise been revealed using current PMS framework applications. The case study approach applied to active project management structures offered additional contributions to the theoretical body of knowledge that have traditionally been beyond the grasp of the accepted body of knowledge for project management (PMBOK, 2013).

## **STUDY LIMITATIONS AND DELIMITATIONS**

This research study analyzed two projects from a projects based technical organization made up of civil service employees with supporting contractor team members. This study researched how the Viable System Model can be adapted for analysis of project management structure. Case Study Research (CSR) was used to accomplish this rigorous research effort. However, the research design and execution introduced limitations concerning the generalizability of the findings. Because the research cases were limited to government projects, no applicability for the results of this research beyond government project situations (within the framework of project types selected) can be directly claimed. Caution should be used in attempting to generalize these findings to other project situations that fall outside of the context of the projects analyzed. This research was not intended to provide a prediction mechanism for

project performance, nor discovery of the theoretical accuracy of the VSM. The VSM looks at project viability rather than in terms of project performance. The results from the exploration of the Viable System Model framework application to active project management structures were presented. This research does not set out to solve the problems of the projects observed, but to highlight the VSM perspective of PMS analysis as an applicable model that offers an alternative frame of reference for examination of project management structure.

A noted bias associated with Case Study Research (CSR) was that CSR is confused with case studies in general. One criticism pointed out by Yin concerning Case Study Research was how case studies are sometimes associated with the exploratory stage of another research method (Yin, 2009). The idea suggests that case study research was in effect limited to being a preliminary step of another research method. This is a poor reflection of what case study research is designed to accomplish. Another flaw in the definition or explanation of case study research was in the earlier use of “participant-observation as a data collection method” (Yin, 2009, p. 5). The presentation and interpretation of the data gathered would later be presented and marked as a case study, in a sense diluting the associated rigor of true case study research (Yin, 2009). By applying a rigorous and methodological approach to research, Case Study Research is an applicable use for rigorous research (Yin, 2009). Therefore, although CSR has limitations, it is appropriate to the present research aims and performed with rigor can provide a design capable of generating a response to the research questions.

One test of possible researcher bias is the “degree to which you are open to contrary findings” (Yin, 2009, p. 72). “If such findings are based on compelling evidence, the conclusion of the case study would have to reflect these contrary findings. To test your own tolerance for

contrary findings, report your preliminary findings –possibly while the data is still in the collection phase-to two or three colleagues. The colleagues use should offer alternative explanations and suggestion for the data collection. If the quest for contrary findings can produce documentable rebuttals, the likelihood of bias will have been reduced” (Yin, 2009, p.72). These discussions will occur during participant discussions.

Case study research is a form of qualitative research. The role of the researcher during case study research requires rigorous structuring of data collected and presentation of results. Qualitative research can wrongfully be viewed as “interpretative research, with the inquirer typically involved in a sustained and intensive experience with participants. This introduces a range of strategic, ethical, and personnel issues into the qualitative research process (Locke, et al, 2007)” as quoted in Creswell, 2009, p. 117. By identifying these issues within the present research, the researcher is able to clarify the ethical and personal issues that may have arisen or been factors of the research. The researcher’s background and capabilities/limitations are expressed in the research study to clarify and bring light to the role of the researcher during the study. This allows the reader to understand the intended viewpoint of the researcher and help to disperse perceived biases that could have otherwise emerged. Creswell noted that “inquirers explicitly identify reflectivity biases, values, and personal background, such as gender, history, culture, and socioeconomic status, that may shape their interpretations formed during study” (Creswell, 2009). Presenting perceived biases will lead to a more credible representation of results by presenting the credibility of the researcher within the context of the research effort (Creswell, 2009). To enhance the accountability for research conclusions and interpretations, the research design actively engaged an accounting of the researchers’ background. This

accountability was achieved in the research design to bolster conclusions and implications drawn from the research effort.

## **RESEARCH SIGNIFICANCE**

The research design determined how the Viable System Model can be incorporated as an organizational structural analysis model capable of providing insights within project based organizations. Thorough research into systems based analysis of Project Management Systems and the Viable System Model's theoretical basis extended both the body of knowledge in the Management Cybernetics as well as Project Management fields. Of particular significance is the lack of research examining the confluence of these two major fields. This confluence has not previously been explored through rigorous research. The research focused on an analysis of the Project Management Paradigm within the theoretical basis for Project Management Systems to determine the significance and potential use of the VSM and how a methodology could be designed to use the VSM in a structural analysis of project-based organizations.

The extension of the VSM as a system theory based model with potential applicability to the Project Management field of study provided an opportunity to examine the confluence between two distinct areas. These areas have developed and evolved independently and their exploration in relationship to one another is new, novel, and creates a significant research endeavor. There is also a practical significance from the research in that viability factors might offer design cues for 'more viable' project organizations as well as creating the potential for improvement to project structures. This systems based examination would not have been realized with today's techniques and methodologies for project management practitioners. The



breadth and depth of this research adds the significance of applying a rigorous case study research design that is not a frequent approach at the intersection of the engineering management and project management fields. In the OCLC WorldCat Database, I found 12,463 instances of key word “Engineering Management” coupled with anywhere in document “case study” anywhere in the document; 178 of them being from dissertations. In the Engineering Village Database I found 85,282 instances of key word “Engineering Management” coupled with anywhere in document “case study” anywhere in the document. The significance of the intersection of these fields was central in driving the development of a theoretical framework that would look at the PM paradigm verses the system theory construct of organizations from the management cybernetics paradigm. Bridging these two paradigms was accomplished through the theoretical foundations introduced by the VSM through case study research. The basis for the theoretical foundations of the VSM were derived from the seminal literature predominately by Stafford Beer (1966, 1981, 1979, 1985, 1994, 2000), Norton Weiner (1948, 1950), and Barry Clemson (1984).

It was significant that the VSM was used as a framework for structural analysis of Project Management Systems using a case study research design. The intersection of the Viable System Model (management cybernetics), project management systems, and case study research was original in formulation and significant in reach across the areas. Significant contributions of this research study are summarized Table 1 below:

	Significant Contributions of this Research Study
Theoretical	1. Extension of the VSM to PMS
	2. Exploration of System Theory with respect to project structure
Methodological	1. Expanding the use of Case Study Research for PMS
	2. Use rigorous case design for engineering management systems
Practical	1. VSM analysis of PMS

**Table 1: Significant Contributions of this Research**

The research of the structural analysis of project management systems is needed by Project Managers. This conceptual research using the VSM and case study research provides original and significant contribution to the engineering management body of knowledge. In addition, it suggests future directions that are not currently part of the mainstream research agenda for either Management Cybernetics or Project Management.

## **DOCUMENT ORGANIZATION**

This dissertation is organized into nine chapters and is shown below in Figure 2:

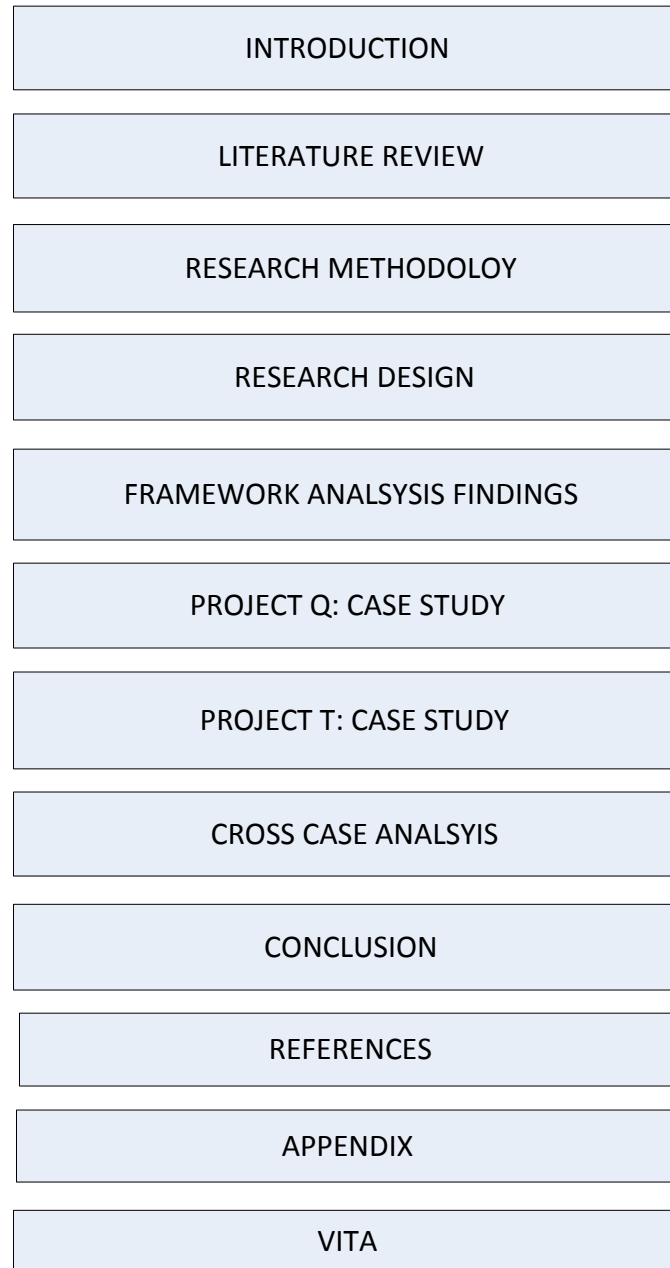

**Figure 2: Dissertation Chapter Organization**

Chapters I through II pertain to the research context of the dissertation, Chapters III and IV pertain to research methods and design, Chapter V pertains to framework analysis, Chapters VI

through VIII pertain to the case study results, and Chapter VIII concluded with the presentation of findings. Chapter I contained the necessary background information and overall perspective for doing this research. The research question was defined and the overall research approach and significance were discussed in Chapter I.

The Literature Review was developed in Chapter II. This review included the development of the Viable System Model and the relationship to Project Management Systems for this research. The case study research methodology was introduced in Chapter II as the foundation methodology guiding inquiry for this research effort.

Chapter III discussed the appropriateness, limitations, and issues of the qualitative research approach as part of the research methodology. Qualitative methods were discussed with a focus on case study research. This Chapter established the research perspective.

Chapter IV developed the research design. The case study methodology was presented from the initial case selection phase to the interpretation of results presented in the final phase of this case study research. This chapter also presented the summary of the VSM to PMBOK PMS matrix Analysis. The results of the data analysis were presented and explained and helped to inform a more robust perspective for examination of project management structure in the case study application.

Chapter V provided the framework analysis findings developed from the analysis of data associated with the VSM framework analysis of the PMBOK PMS. Chapters VI and VII presented the case study narratives developed from the analysis of data associated with the VSM framework analysis of PMS in two different project scenarios. Each case study narrative was derived from the data collected from each individual project.

Chapter VIII provided the cross case analysis and case results attained from the two case studies. Each of the systems and channels of the VSM were compared between the two projects as part of the cross case analysis.

Chapter IX presented the conclusion and implications of this research effort for the application of the VSM to PMS structure. This chapter contained research based implications of the VSM applied to the study of PMS. This chapter also discussed possible future research in the concerning the use of VSM for PMS and concluded with a review of the research questions in light of the research results.

This chapter of the document examined the significance of the research concerning systems based analysis of Project Management Systems and the Viable System Model. The theory extends both areas through examination of the intersection which has not previously been explored through rigorous research. Also significant is the use of case study research of project management structures. The remainder of the chapter summarizes the chapter contents of this research effort.

## LITERATURE REVIEW

### INTRODUCTION

A literature review was performed to explore the current state of knowledge with respect to Project Management Structures, the Viable Systems Model, and Case Study Research as related to project based organizations. The foundation works of Cybernetics and the VSM by Beer, Clemson, and Wiener point to a different perspective of system analysis that has not fully been adopted nor integrated into the reductionist based system analysis that is more mainstream to analysis of organizational management (Beer, 1979; Wiener, 1950). There is a significant gap in frameworks to evaluate engineering management strategies for project based organizations. As noted by Perttu Dietrich and Paivi Lehtonen (2005), “Most of the models and frameworks presented in the literature are theoretical constructions to solve or describe managerial problems with multiple projects....current literature lacks empirical evidence on the functionality of different management approaches, formal or informal”. There is a significant gap in frameworks to evaluate engineering management strategies for project based organizations as noted by Aubry, Hobbs, and Thuiller’s (2007, p. 328) suggestion that “the current project management literature is lacking two elements: theoretical foundations and valid, verified empirical models”. The Viable System Model offers an established model that could be used to evaluate project based organizations and provide insight into viability of system effectiveness for project managers. The VSM provides understanding of the complexity which “has become virtually unmanageable with existing managerial tools” (Beer, 1979). Beer’s early assertion still appears to be the case with modern organizations. This research filled a significant gap in the study of engineering management within project based organizations and contributed positively to the

overall body of knowledge within this discipline. The literature review explored available literature on Project Management Systems (PMS), the Viable System Model (VSM), and Case Study Research (CSR) that form the basis of this research. The Literature Review of Figure 3 below visually depicts the streams of the literature review:

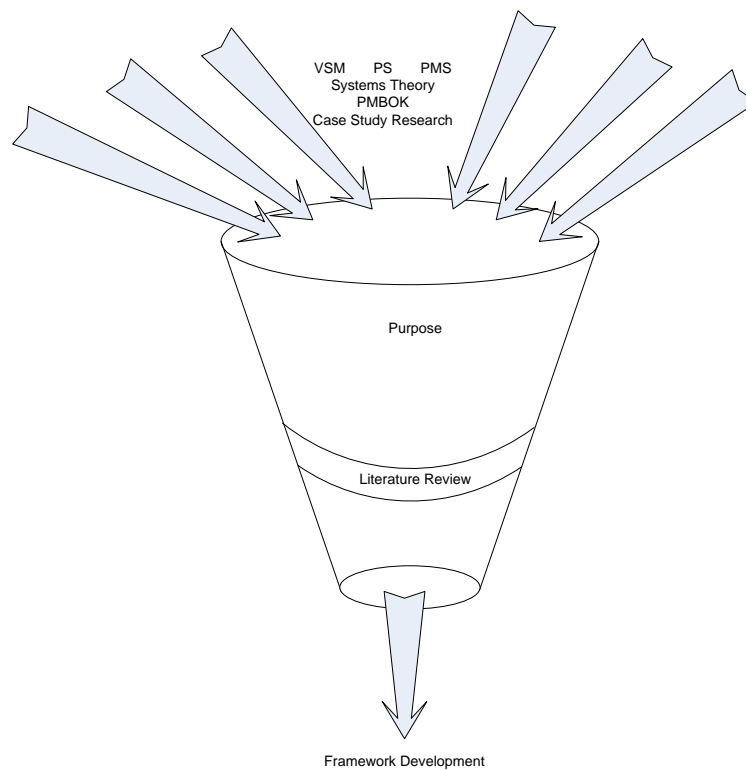

**Figure 3: Literature Review Process**

The literature review chapter reports examination of the origins and essence of the VSM. The criticisms of the VSM and application areas of the VSM were also reviewed. This section closes

with the definition of the VSM's systems and channels and the how the VSM was adapted for use in Case Study research to explore project structure.

## **PROJECT MANAGEMENT SYSTEMS (PMS)**

The system analysis frameworks used today to describe project based organizations were reviewed through scientific journals and textbooks. The Project Management Journal and the International Journal of Project Management are two examples of the primary scientific journals used for discovery. A simple definition of a project is considered to be “a series of activities or tasks that have a specific objective, have defined start and stop dates, have funding limits, and consume resources” (Kerzner, 1998, p. 2). Project management is the management of projects (Kerzner, 1998). A classic view described Project Management as the planning, organizing, staffing, controlling, and directing of personnel and resources associated with the activity or task (Kerzner, 1998). The literature reflected the new realization of the importance of project selection on overall organizational viability. The goal of project selection is “to create value for the business” (Aubrey, et al, 2007, p.328). The literature acknowledged efforts to form Project Management Offices (PMOs) and redefine project manager responsibilities to focus on project purpose with respect to organizational value (Aubry, et al, 2007, p. 328). The importance of project selection to the overall well-being of the organization was discussed but universal frameworks have not been offered to begin to isolate and define project level viability. “Project teams are temporary and a lot of learning may be lost when they disband” (Ruusak, Vartianinen, 2005, p.374). The literature pointed to hierarchal management style advantages and business leadership goals to achieving success, but falls far short of providing an accessible framework



that that could examine viability as postured by the Viable System Model. This depth of examination is evident from Table 2 of the literature review. Table 2 highlights the areas of literature that emerged from the review of Project Management Systems and notes the lack of System Theory literature directed toward PMS.

The literature review explored the writings associated with the systems view of PMS's. A program is defined as "a group of related projects, subprograms, and program activities managed in a coordinated way to obtain benefits not available from managing them individually" (PMBOK, 2013, p. 9). The literature review searched for articles that discussed project management structure and were categorized below in Table 2 to show the scarcity of literature available on project management structure:

Authors	Project Definition	Link Projects with Business Strategy	Project Structure Analysis	View Projects as Building Blocks of an Organization	View need for PMO for Multiple Project	Project Success Performance	System Theory
(Dietrich & Lehtonen, 2005){Aramo-Immonen, 2009 #758}	Yes	Yes		Yes		Yes	
(Hobbs & Aubry, 2007)	Yes			Yes	Yes		
(Srivannaboon, 2006)	Yes	Yes		Yes		Yes	
(Aubry, et al., 2007)		Yes		Yes	Yes	Yes	
Ruuska, I.; Vartiainen, M.	Yes			Yes			
(Sense, 2008)		Yes	Yes		Yes	Yes	
(Caron, Fumagalli, & Rigamonti, 2007)		Yes		Yes			
(Stewart, 2008)		Yes		Yes			
(van Donk & Molloy, 2008)	Yes	Yes				Yes	Yes
(Olsson, 2006)	Yes	Yes		Yes			
(Reich, 2007)	Yes	Yes	Yes			Yes	
(Cicmil & Hodgson, 2006)	Yes		Yes			Yes	Yes
(Kolltveit, Karlsen, & Grønhaug, 2007) Gronhaug, K.	Yes		Yes				
(Pant & Baroudi, 2008)						Yes	
(Sutterfield, Friday-Stroud, & Shivers-Blackwell, 2006)	Yes		Yes				
(Martinsuo, Hensman, Artto, Kujala, & Jaafari, 2006)		Yes		Yes	Yes		
(Rozenes, Vitner, & Spraggett, 2004)	Yes		Yes	Yes		Yes	
(Thiry, Deguire, & Irnop, 2007)		Yes		Yes	Yes		
(Pollack, 2007)	Yes		Yes				
Vitner, G.; Rozenes, S.; Spraggett, S.						Yes	
(Aramo-Immonen & Vanharanta, 2009)	Yes	Yes	Yes	Yes			Yes

**Table 2: Literature Review for Project Management Systems**

The limited available literature revealed the need for further research in Project System theory as it pertains to Management Structure. *Project Management for Business, Engineering, and Technology*, by Nicholas and Steyn (2008), offered some insight into the system's view of the design process associated with project management structures. For example, Nicholas and Steyn

(2008) describe a four phase approach of the systems development cycle: concept phase, definition phase, execution phase, and operation phase as seen in Figure 4 below:

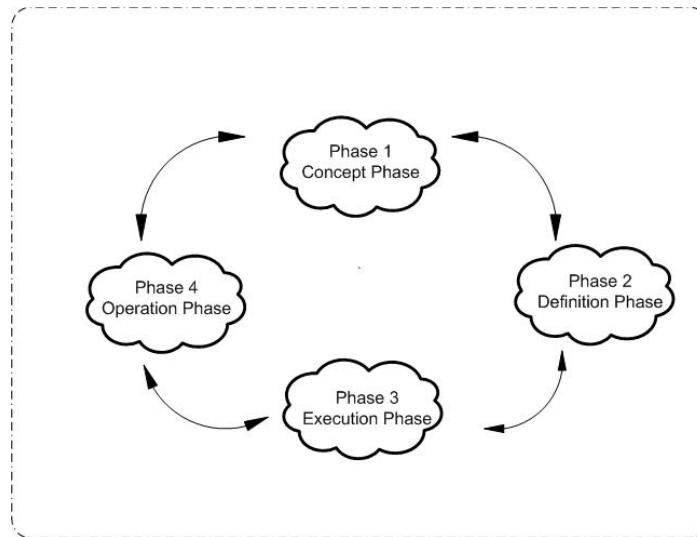
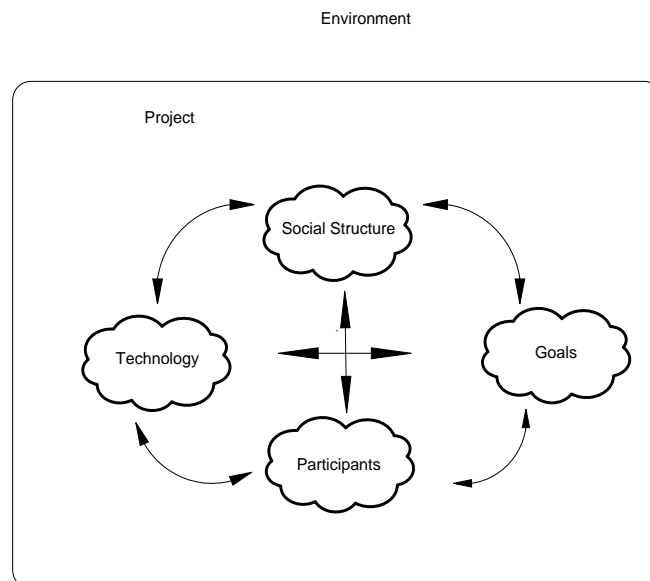

**Figure 4: System Development Cycle {Adapted from Nicholas and Steyn (2008, p. 119)}**

The individual phases of the project management systems development cycle are viewed here from a system's perspective. This example illustrated the need to attain more knowledge into the project management structure in the context of engineering management and the need for more useful tools to support such analyses. While continuous planning and project related functions are highlighted and explained in the example, the need for more systemic perspectives of internal interactions and the viability of project based organizations are lacking adequate foundations of research. This exemplifies the state of Project Management literature with respect

to a Systems Theoretic perspective demonstrates not only the scarcity of the intersection but also the limited depth and sophistication of rigorous accounting of Systems Theory in PMS.

Project structure can be described from the perspectives of social structure, goals, participants, technology, and the environment as seen in Figure 5, A Model of a Project adapted from Leavitt's Diamond, (Scott, 1998) below:



**Figure 5:** A Model of a Project {Adapted from Leavitt's Diamond, (Scott, 1998, p. 17)}

A model of a project is shown in Figure 5 and reflects how the technology, social structure, goals and participants are interrelated within an organization. These interactions within the project are influenced by the environment. The current literature is lacking the empirical analysis of project management structure of projects (Scott, 1998).

Project Management Structures described in the literature tend to focus on the hierarchical interconnections associated with the top down management pyramid where the project leader (at the top) manages the workforce below. For example, Scott (1998) suggests that the project would be divided into five phases: conceptual, definition, production, operational, and divestment. The responsibility for the project would be with the project lead. How the project was considered to be viable as a project was never discussed; rather an emphasis was placed on meeting the milestones of the five cycles.

The project management structure of the project was not designed for viability, but rather the pre-determined success factors associated with initial project's objectives (PMBOK, 2013). Project success is the completion of pre-defined success factors. Project management of viability is the management of projects to ensure they are viable as a project and to the organization. This lack of emphasis on project viability in the initial construction and duration of the project creates the void where the adapted VSM for PMS can help to fill within the body of knowledge of project managements systems.

The structure associated with the models presented by Project Management Body of Knowledge (PMBOK, 2013) and the VSM offer insight into the project structure. PMBOK will be viewed through the VSM lenses. Dietricha and Lehtonen (2005, p. 386) point out that “projects and project management serve as primary capabilities of an organization to respond to change and thereby maintain a competitive edge.... Projects may be considered as building blocks in the design and execution of future strategies of the organization .... . Current literature lacks empirical evidence on the functionality of different management approaches, formal or informal”. Also, they add that “Described models are often context-related, present often

relatively local solutions to related problems and thus the generalizability of the results seldom can be confirmed” (Dietrich, Lehton, 2005, p.386). “Single project characteristics and management activities are closely related to the overall success of the organization” (Dietrich, Lehton, 2005, p.387). There is also an emphasis on linkage of projects to wider organizational aims, “When organizations link their projects to their business strategy, they are better able to accomplish their organizational goals” (Srivannaboon, 2006, p. 89). Sense (2008) wrote on the conditioning of project participant’s authority to learn within projects and the role the sponsor played with their hierarchical oversight where they may felt the lack of authority to learn. “Preventing project failure has become increasingly critical” within organizations (Donk and Molloy, 2008, p. 129). There is also a suggestion concerning separation of projects from other organizational functions, “Project management literature for the most part treated projects as a sub-set or branch of organization(s) at best and a concept utterly disconnected from the organization at worst” (Donk and Molloy, 2008, p. 130). Donk and Molloy (2008, p. 130) go on to suggest that “As a consequence, all types of organizational phenomena are transformed and reduce to being understood within narrow project management terms, or projects are seen as separate entities within an organization but somehow untouched by the activities of the host organisation”. When organizations define projects as temporary organizations” they use this definition mainly to distinguish it from a hierarchical, functional organisation as being a permanent setting” (Donk and Molloy, 2008, p. 130). “In the current literature internal and external factors are already seen as being relevant to project management, such as, project environment, power, structure, and technology” (Donk and Molloy, 2008, p. 130). The need to “focus on structural, contextual and contingent factors of projects supports an exploration of the

relevance of organizational theory to project management, further, it illustrates that the existing literature implicitly addresses different projects structures and contingency factors that influence the design parameters within those structures” (Donk and Molloy, 2008, p. 131). Olsson (2006) discusses the need to keep projects focused while still being able to adapt to organizational changes caused by environmental uncertainty. The research of Olsson (2006, p. 68) points out that “the literature review found that flexibility is primarily an approach to improve effectiveness of projects rather than efficiency”. Cicmil and Hodgson (2006, p. 111) write “several prominent authors (Koskela and Howell, 2002; Maylor, 2001; Morris, 2004; Morris, Patel and Wearne, 2000; Winch, 1996) have raised the need to introduce alternative theoretical approaches to the study of projects, and to identify the implications that they have for how we organize and manage projects”. Cicmil and Hodgson further add that (2006, p. 112) “identified three major deficiencies which are ingrained, maintained, and reproduced across the research field (of project management knowledge) through certain ontological, epistemological, and methodological assumptions: (1) the assumed universality of project management theory; (2) the lack of empirical studies of projects; and (3) the lack of alternative representations of “project””. Kolltevit, et al, (2007 p. 8) found that “the task and leadership perspectives together are dominant in modern project management literature.....focuses more on leadership than the traditional literature used to.....the leadership perspective is the single most used perspective today, and the project management literature shows a growing application of this”. Pant and Baroudi (2008, p. 124) write about “the importance of human skills in project management”, further adding that “ Project management is being viewed as the “new” form of general management which enables organisations to integrate, plan, and control schedule-intensive and

one-of-a-kind endeavors in order to improve overall organisational performance” (Pant and Baroudi, 2008, p. 124). “There is a lack of research that actually examines the process management process through the theoretical lens of stakeholders theory (e.g. Bourne & Walker, 2005, 2006), as well as a lack of research that has applied both stakeholder theory and the strategic management process to the project management” (Sutterfield, Friday-Stroud, Shivers-Blackwell, 2006, p. 26). “It is vitally important to the success of a project to have a project champion or sponsor” (Sutterfield, Friday-Stroud, Shivers-Blackwell, 2006, p. 30). Rozens, Vitner, and Spraggett (2006) add that they “are not aware of any literature survey on the subject of ‘project control’ undertaken over the past couple of decades”. They write that “the main argument against the BoK approach is that a single methodology does not fit all kinds of projects” (Rozens, Vitner, and Spraggett, 2006, p. 6). In addition, “The PMBOK Guide does not refer to project control as a Knowledge Area”, but is embedded in other areas (Rozens, Vitner, and Spraggett, 2006, p. 6). “The PMBOK Guide defines the use of 21 processes that relate to planning, out of the 39 processes required for proper project management” (Rozens, Vitner, and Spraggett, 2006, p. 6). Although the benefits of PMBOK are recognized the implications of the above is that not one model defines all projects. The concept of a project based organization has emerged as noted by the following views. “The project management world uses one-dimensional control systems although these do not integrate project objectives in any way. The main reason for using the one-dimensional control systems is its simplicity of implementation” (Rozens, Vitner, and Spraggett, 2006, p. 11). Thiry and Dguire (2007, p. 649) recognize “project-based organisation have received increasing attention in recent years as an emerging organizational form”. There is a need for “a collaborative relationship between the fields of



project and general management and the importance of developing a common language that fosters dialogue” (Thiry and Dguire, 2007, p. 656). With the view of project based organizations comes the need for the management structure to manage these organizations. Cicimil, et al, (2006, p. 675) write of the “ontological, epistemological, and methodological assumptions underlying this (actuality) kind of research”. “Models need to incorporate not only “real” data but management perspectives of data” (Cicimil, et al, 2006, p. 683). Management’s perspective of the data contributes to the context of the data, given it more meaning. “The theoretical basis of PM is predominately implicit, and discussion of the theoretical basis of PM is rare” (Juilen Pollack, 2007, p. 272). Based on the above views, the need for a theoretical foundation for the PM of project based organizations is needed.

Based on the literature for Project Management Systems, we can make three primary conclusions. First, there is scarcity of the literature concerning Project Management Systems. Second, the reference to ‘systems’ in this literature does not find a deep basis in the foundations of systems theory or applications. Third, there is not rigorous empirical research that examines the nature, design, analysis or development of Project Management Systems from a systems theoretic perspective.

### **PMS: PMBOK PERSPECTIVE**

The Project Management Body of Knowledge (PMBOK) provides “guidelines for managing individual projects and defines project management concepts. This document is accepted throughout the world as a definitive guide and knowledge source for the project management profession. PMBOK discusses the project management life cycle and associated

processes (PMBOK, 2013). The PMBOK provides for “a common vocabulary within the project management profession for using and applying project management concepts” (PMBOK, 2013, p. 2). “A common vocabulary is an essential element of a professional discipline” (PMBOK, 2013, p. 2). PMBOK is a recognized standard that is a guide rather than a specific methodology (PMBOK, 2013). The accepted definition of project stemming from PMBOK is “A project is a temporary endeavor undertaken to create a unique product, service, or result” (PMBOK, 2013, p. 3). PMBOK notes that a project can create the following (PMBOK, 2013, p.3):

1. A product that can be either a component of another item, an enhancement of an item, or an end item in itself.
2. A service or a capability to perform a service.
3. An improvement in the existing product or service lines.
4. A result, such as an outcome or document.

“Project Management is the application of knowledge, skills, tools and techniques to project activities to meet the project requirements” (PMBOK, 2013, p. 5). PMBOK also divides project management into five Process groups (PMBOK, 2013, p. 5):

1. Initiating.
2. Planning.
3. Executing.
4. Monitoring and Control.
5. Closing.

PMBOK notes that “specific project characteristics and circumstances can influence the constraints on which the project management team needs to focus” (PMBOK, 2013, p. 6). “The project management team needs to be able to assess the situation, balance the demands, and maintain proactive communication with the stakeholders in order to deliver a successful project” (PMBOK, 2013, p. 6). The Project Management Plan (PMP) is an iterative activity that continuously involves improving and detailing the plan as additional detailed/specific information and more accurate estimates become available (PMBOK, 2013). PMBOK notes that projects are often utilized as a means of directly or indirectly achieving objectives within an organization’s strategic plan and are typically authorized as a result of one or more of the following strategic considerations (PMBOK, 2013):

1. Market demand.
2. Strategic opportunity/business need.
3. Social need.
4. Environmental consideration.
5. Customer request.
6. Technological advance.
7. Legal requirements.

The PMBOK outlines the nature and role for the project manager. The project manager is the one assigned by the organization to lead the project and becomes the link between the organizational strategy and the project team (PMBOK, 2013). PMBOK adds that “An organization’s culture, style, and structure influence how the projects are performed” (PMBOK, 2013, p. 20). PMBOK defines project manager skills as the following (PMBOK, 2013, p. 17-18):

1. Leadership.
2. Team building.
3. Motivation.
4. Communication.
5. Influencing.
6. Decision making.
7. Political and cultural awareness.
8. Negotiation.
9. Trust building.
10. Conflict management.
11. Coaching.

PMBOK recognizes organizational communications and its importance in today's world.

“Stakeholders and project teams members can also use electronic communications (including e-mail, texting, instant messaging, social media, video and web conferencing, and other forms of electronic media) to communicate with project manager formally or informally” (PMBOK, 2013, p. 21). PMBOK also notes several types of organizational structure that can be implemented and impact project performance (PMBOK, 2013, p. 22):

1. Matrix (weak, balanced, or Strong).
2. Projectized.

Each structural form has unique characteristics that the project manager becomes familiar with and works with as part of the culture of the organization. The project manager utilizes the Organizational Process Assets (OPAs) of the organization to accomplish their project.

“Organizational process assets are the plans, processes, procedures, and knowledge basis specific to and used by the performing organization. They include any artifact, practice, or knowledge from any or all of the organizations involved in the project that can be used to perform or govern the project” (PMBOK, 2013, p.27). PMBOK defines a stakeholder as “an individual, group, or organization who may affect, be affected, or perceive itself to be affected by a decision, activity, or outcome of a project” (PMBOK, 2013, p. 30). The roles of the project lead within an organization were described and shown to be the central point of communications between the project team and the organization. As project lead, strategic vision and stakeholders interfaces are an important role for the project lead.

As a summary to this point, PMBOK has described and defined the guidelines of project management in terms of the project and its life cycle. A project had been described in terms of its purpose. PMBOK describes the division of project management into five process groups each having its own distinct characteristics. The PMP is described as being the ‘plan’ for the project and is described as being the interface to the strategic agenda of the organization. The project lead is chosen from the organization and represents the strategic link between the organization and the project. PMBOK defines its perspective of the leadership role of the project manager and defines the Organization Process Assets (OPA) that are available to them. The unique Organization Process Assets help define the culture and structure of the organization from which the project is included. The next areas of consideration in review of project management, from the perspective of the PMBOK, are project governance, project success, and the project life cycle as described through the PMBOK lenses. Notably absent in the PMBOK presentation of project management is acknowledgment, development, or explicit recognition of the nature or role of

Project Management Systems or the deeper systemic perspective for project management.

However, for the execution of PMBOK, processes specified might be extrapolated to roughly denote a systems view.

The PMBOK does note the role of governance, suggesting that “Project governance – the alignment of the project with stakeholders’ need or objectives – is critical to the successful management of stakeholder engagement and the achievement of organization objectives” (PMBOK, 2013, p.30). PMBOK also notes that it’s the project manager responsibility to manage stakeholder expectations (PMBOK, 2013, p. 32). Project governance is described below (PMBOK, 2013, p. 34):

1. Includes a framework for making project decision.
2. Defines roles, responsibilities, and accountabilities for the success of the project.
3. Determines the effectiveness of the project manager.

“Project governance is defined by and fits within the larger context of the portfolio, program, or organization sponsoring it, but is separate from organizational governance” (PMBOK, 2013, p. 34). Project success is a major element of project management and “should be measured in terms of completing the project within the constraints of scope, time, cost, quality resources, and risk as approved between the project managers and senior management” (PMBOK, 2013, p.35).

PMBOK describes project team roles to include the following (PMBOK, 2013, p.35):

1. Project management staff.
2. User or customer representatives.
3. Sellers.
4. Business partner members.

5. Business partners.
6. Project staff.
7. Supporting experts.

The preeminence of the life cycle in project management is evident in PMBOK, detailing that “A project life cycle is the series of phases that a project passes through from its initiation to its closure. The phases are generally sequential, and their names and numbers are determined by the management and control needs of the organization or organization involved in the project, the nature of the project, and its area of application (PMBOK, 2013). Characteristics of the project life cycle are (PMBOK, 2013, p. 39):

1. Starting the project.
2. Organizing and preparing.
3. Carrying out the project work.
4. Closing the project.

PMBOK reiterates that project management “is the application of knowledge, skills, tools and techniques to project activities to meet the project requirements. This application of knowledge requires the effective management of the project management processes” (PMBOK, 2013, p. 47). “A process is a set of interrelated actions and activities performed to create a specified product, service, or result ...characterized by its inputs, the tools and techniques that can be applied, and the resulting outputs” (PMBOK, 2013, p. 47). The project manager ensures project success by choosing the processes that produces the required results (PMBOK, 2013). PMBOK uses project management process groups to categorize project management. Table 3, Project Management

Process Group and Knowledge Area Mapping, below links the process groups to the knowledge management areas for project management (PMBOK, 2013, p. 61):

Knowledge Management Areas	Project Management Process Group				
	Initiating	Planning	Executing	Executing and Monitoring and Control	Closing
Integration	Develop Project Charter	Develop Project Management Plan	Direct and Manage Project Work	Monitor and Control Project Work Perform Integrated Change Control	Close Project or Phase
Scope		Plan Scope Management Collect Requirements Define Scope Create WBS		Validate Scope Control Scope	
Time		Plan Schedule Management Define Activities Sequence Activities Estimate Activity Resources Estimate Activity Durations Develop Schedule		Control Schedule	
Cost		Plan Cost Management Estimate Costs Determine Budget		Control Costs	
Quality		Plan Quality Management	Perform Quality Assurance	Control Quality	
Human Resources		Plan Human Resource Management	Acquire / Develop / Manage Project Team		
Communications		Plan Communications Management	Manage Communications	Control Communications	
Project Risk		Plan / Identify Risks /Risk Response Perform Qualitative / Quantitative Risk Analysis		Control Risks	
Project Procurement		Plan Procurement Management	Conduct Procurements	Control Procurement	Close Procurements
Project Stakeholder	Identify Stakeholders	Plan Stakeholder Management	Manage Stakeholder Management	Control Stakeholder Engagement	

**Table 3: PM Process Group and Knowledge Area Mapping {Adapted from PMBOK, 2013}**

PMBOKs method for describing the process roles is consistent in that each role is defined by its inputs, tools & techniques, and outputs, thus providing a consistent method for defining the 47



process roles that make up the project management process group and knowledge area mapping (PMBOK, 2013).

PMBOK describes the purpose and definition of what a project is within an organization. PMBOK also describes the roles and expectations of the project lead and the strategic roles it plays within the organization. The alignment of stakeholders to the project's goals and the organizational strategy were described as the project's governance within the organization. The decision framework and roles and responsibilities of the team as defined within PMBOK's governance. The confluence of the Project Management Process Groups defined by PMBOK and the related Knowledge Management Area together provide governance guidance to the project manager. The decision making governance defined by PMBOK helps define the framework of the project management structure. The PMBOK states that "Operations management is a subject area that is outside the scope of formal project management as described in this standard" (PMBOK, 2103, p.13). Project based organizations are those "that create temporary systems for carrying out their work. The use of (Project Based Organizations) PBOs may diminish the hierarchy and bureaucracy inside the organizations as the success of the work is measured by the final result rather than by position or politics" (PMBOK, 2013, p. 14). This review of the PMBOK was used as the project based standard framework of analysis for discovery of the intersection and implications of incorporation with the VSM. This perspective was an essential element to derive the theoretical frame of reference for conducting the following case study research design.

## **CYBERNETICS: PRELUDE TO THE VSM**

The underlying theoretical foundation for the VSM is based on cybernetics. Cybernetics is the ‘science of control’; cybernetics can be management’s ‘profession of control’ (Beer, 1981). Cybernetics is “concerned with general patterns, laws and principles of behavior that characterize complex, dynamic, probabilistic, integral and open systems” (Clemson, 1984, p. 19). Cybernetics highlights the existence of circular causality (feedback) and the concept of systems having a ‘holistic’ behavior. The holistic behavior is described as belonging to the system and not the individual parts (Beer, 1979; Patton, 2002). Beer (1979) states that a system “consists of a group of elements dynamically related in time according to some coherent pattern” (Beer, 1979). This research examined the project as a system composed of the project team and their associated functions. The observer of the system was the one that recognizes the purpose of the system; i.e. what the system does (Beer, 1979). The characteristics of a system emerged from the interaction of the parts, actions from whose individual parts, together created reactions not otherwise understood by looking at the individual parts separately (Clemson, 1984). Stafford Beer’s *The Brain of the Firm* proposed the use of a neurocybernetic model to be used as the model of a viable system for any organization. It is here that Stafford Beer suggested that “the human nervous system stipulates the rules whereby an organisation (United Kingdom’s spelling of ‘organization’ and maybe used interchangeably throughout this document) is survival-worthy: Is regulated, learns, adapts, evolves” (Beer, 1979, p. xi).

The laws of cybernetics are founded around three basic laws: (1) The Self-Organizing Systems Law; (2) Feedback; and (3) The Law of Requisite Variety. The Self-Organizing System Law states:

*Complex systems organize themselves; The characteristic structural and behavior patterns in a complex system are primarily a result of the interactions among the system parts.* (Clemson, 1984, p. 26)

Within this realm is a sub-law that “complex systems have basins of stability separated by thresholds of stability” (Clemson, 1984, p. 27) . “The mechanism through which complex systems organize themselves is, to a large extent, through sets of interlocking feedback loops. Parts A interacts with Part B and Part B affects Part A and they tend to continue to interact with each in some region of stability under the conditions provided by the other” (Clemson, 1984, p. 40). The interactions of a project as it relates to viability are a critical part of this research effort.

The Feedback Law states:

*The output of a complex system is dominated by the feedback and, within limits, the input is irrelevant.* (Clemson, 1984, p. 24)

Within this realm is a sub-law that states “All outputs that are important to the system will have associated feedback loops” (Clemson, 1984, p. 30). Feedback within projects will be explored along within the interactions of the project participants.

The Law of Requisite Variety states:

*Given a system and some regulator of that system, the amount of regulation attainable is absolutely limited by the variety of the regulator”.* (Clemson, 1984, p. 36)

The Law of Requisite Variety highlights the importance of continuous interactions between the system and the regulator. Variety is the technical expression for complexity of the systems or the number of states a system may have. Ashby’s Law of Requisite Variety: “control can be obtained only when the variety of the controller (and in this case of all the parts of the controller) is at

least as great as the variety of the situation to be controlled” (Beer, 1981, p. 41). “The paradigm conflicts somewhat with our traditional images of science and ways of thinking about complex phenomena such as organizations. The cybernetic paradigm developed herein builds and broadens our image of what constitutes science and thereby provides powerful new ways of dealing with extreme complexity” (Clemson, 1984, pp. 44-45). Project complexity was explored and the ways of controlling this complexity was observed. The measure of complexity is ‘variety’ and Beer (1979) refers to ‘variety’ as the measure of the “number of possible states of whatever it is whose complexity we want to measure” (Beer, 1979, p. 23). For the researcher, the object is to observe the flexibility of the way one measures complexity, and the astonishing range of variety that a system can exhibit, depending on the chosen definition of the system by the researcher. Ashby’s Law describes the conditions under which a complex system can be externally controlled (Espejo & Harnden, 1989). Understanding these conditions under which complex systems can be controlled is an underpinning for the understanding of how the VSM works. There is a way of looking at creation which emphasizes the relationships between things equally with the things themselves. This approach is called the “system’s view” and highlighted below (Espejo & Harnden, 1989):

1. A system is a bounded collection of three types of entities: elements, attributes of elements, and relationships among elements and attributes. Both attributes and relationships are characterized by functions called ‘variables’, which include the familiar quantifiable variety as well as the non-numerical types described by Warfield and Christakis (1987). The ‘state’ of a system at any time is the set of values held by its variables at that time.

2. The values of certain variables of the system must remain within physiological determined limits for the system to continue in existence as the system; these are called 'essential' variables (Ashby, 1960, p. 41) of the system; examples are blood pressure and temperature in human systems and cash flow and net income in the firm.
3. Many system variables display equilibrium; that is, a tendency toward a single or small range of values, and when displaced from these values, a tendency to return. This quality, exhibited by all living systems, is known in teleological or goal-seeking behavior.
4. Within the category of living goal-seeking system is the class of systems whose goals and reasons for existence are consciously set by man, called 'purposive' (Beer, 1959) or 'purposeful' (Ackoff and Emery, 1972) systems.
5. Most natural systems are 'complex', which means that their possible states are so numerous that they cannot be counted in real time. The unit of complexity is 'variety'. The variety of a dynamic system is the number of distinguishable states that it can occupy. The essential quality of a complex system is that its variety is so great that it cannot be controlled or managed by any method that depends on enumerating or dealing sequentially with its states.
6. Ashby's Law of Requisite Variety states that to control a complex system, the controlling system must generate at least as much variety as the system being controlled: 'Only variety in the control mechanism can deal successfully with variety in the system controlled' (Beer, 1959, p. 50).

7. The concept of systemic 'control' operates at two levels. First is physiological control, required to allow the system to continue in existence (see 3 above); the values of all the essential variables are held within physiologically set tolerances. If physiological control fails, the system dies.
8. The second level is operational control, or the control of one system by another. This also requires the presence of physiological control, but in addition requires the maintenance of the value of a set of variables (essential or otherwise), chosen by the controlling system, according to its purpose for existence (see 5 above and 9 below), within tolerances set by the controlling system. If operational control fails, the system can still live, but (by definition) it fails to accomplish its purpose. Ashby's law governs both types of control.
9. An 'organization' is a complex purposive system that man brings into being (or maintains in being) for the purpose of creating some desired change in the environment (i.e. society, organization, etc.). In order to accomplish its societal purpose the organization must have the ability and power to influence and cause change in other organizations and the other complex natural systems that make up its environment. The organization must operationally 'control' some part of the environment, which requires (Ashby's Law) that it must possess – contrary to normal expectations – at least as much variety as the societal systems it strives to control (Beer, 1981).
10. In classical cybernetics, there are only three methods that an organization (or any system intent on operationally controlling another complex system) can use to

establish the variety surplus it needs: it can amplify its own variety beyond that of the system to be controlled; it can exactly match its variety to that of the system to be controlled (a special case); or it can reduce the variety of the system to be controlled to less than its own.

Cybernetics as a 'science of control' examines the 'holistic' system verses just its individual parts (Beer, 1981). The cybernetic basic laws and the law of Requisite Variety described above form the foundations used for the VSM. The variety and complexity of describing organizations using the systems view was articulated by Espejo & Harnden (1989) and described in the previous 10 points as the emphasis of the relationship between things equally with the things themselves; things being the components of the system.

### **VIALE SYSTEM MODEL (VSM)**

The Viable System Model (VSM) is a model of the organizational structure of a viable system developed by Stafford Beer (1966, 1981, 1979, 1985, and 1994). Beer (1981, 1979) has explained how management manages a process within an environment and how the interactions of these processes reflect the two-way communications between those components of these processes. Beer (1981, 1979) explains the levels of communication between the components as being 'variety' (the measure of complexity). Variety is seen as the number of possible states of the system. Beer (1981, 1979) further describes the organization as having multiple operations that require management. When brought together as a whole, Beer (1981, 1979) describes the organization as being made up of Five Systems, each with its own unique characteristics. The system (organization or project) is deemed viable if it is regulated, learns, adapts, and evolves

itself (Beer, 1981, p. 7). A System “consists of a group of elements dynamically related in time according to some coherent pattern” (Beer, 1981, p. 7). We now shift focus to examination of the five systems Beer identifies for his Viable System Model (Beer, 1979).

The Five Systems are shown to communicate with each other in the Viable System Model and work to balance the system to ensure that variety generated within the system is absorbed. A Viable System Model can be seen in Figure 6 below to highlight the systems and their interactions (a project organization can be viewed as a system, performing the functions specified by Beer’s VSM to maintain viability) within a project or organization:



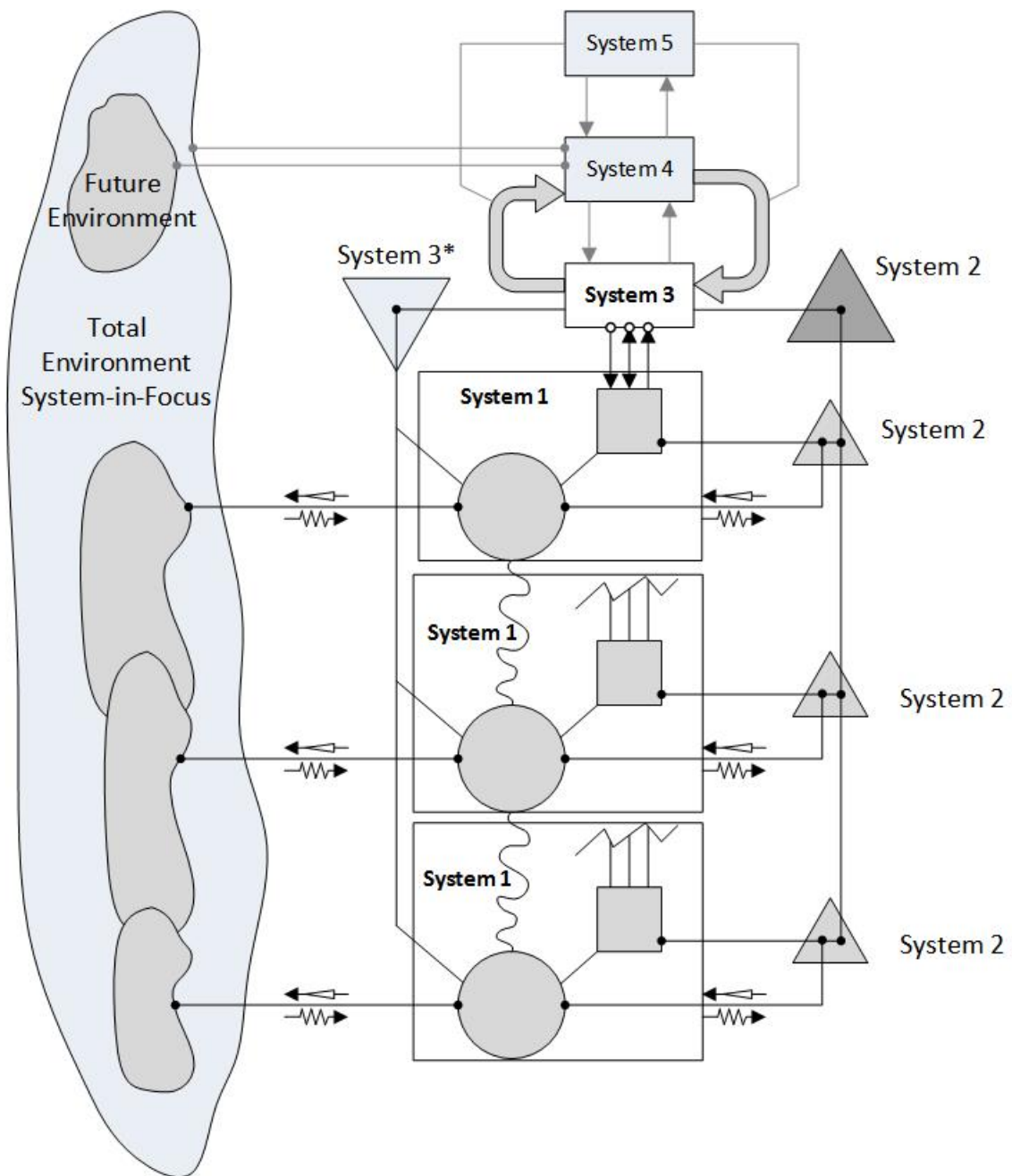

**Figure 6: Viable System Model {Adapted from Ríos, 2012, p. 49}**

The VSM can be used to develop a model of an organization (or project) to clearly show how an organization functions as compared to the way the organization may be perceived to be functioning. Once developed, the model can be used to identify areas where changes could be made to improve the organization. These changes may be for streamlining the organization or to make it more effective in its working environment (Beer, 1981). The Viable System Model is intended as a diagnostic tool (Beer, 1981). The diagram is setup to have logical not organizational implications (Beer, 1981). Beer further states that a researcher can “map the exact organization onto the model, and then ask whether the parts are functioning in accordance with the criteria of viability, as these have been set forth in neurocybernetic language” (Beer, 1981, p. 7). The mapping does not create an organizational chart, but rather focuses on the process and communication aspects of the organization (Beer, 1981). The processes are not assigned to one person as in a hierarchal chart, but are seen to be spread out throughout the organization. Following these processes and the communication associated with these interactions help define the underlying aspects of the VSM. The variety of roles required of the viable system is spread throughout the activity. The VSM, when modeling a branch within an organization similarly follows the same conventions when describing the divisions above or when describing the project operations below the branch level of organizations. “The whole of the chart is reproduced within each circle representing a division, and of course this means in turn that (if we could write or read that small) the whole chart would be reproduced in each division of each division – which is to say in each little circle within every big circle” (Beer, 1981, p. 156). This makes this a “competent chart for any organization” (Beer, 1981, p. 156). The hierarchal chart is referred to as the ‘machine for apportioning blame’ that the organization chart comprises (Beer, 1979). The

emphasis of this research will be to look at how the Viable System Model (VSM) can be adapted for analysis of project management structures.

Beer discusses in *Decision and Control* (1966) the concepts and the three essential characteristics of a viable system:

1. “Viable systems have the ability to make a response to a stimulus which was not included in the list of anticipated stimuli when the system was designed. They can learn from repeated experience what the optimal response to that stimulus is. Viable systems grow. They renew themselves- by, for example, self-production. They are robust against internal breakdown and error. Above all, they continuously adapt to a changing environment, and by this means survive – quite possibly in conditions which had not been entirely foreseen by the designer” (Beer, 1966, p. 256).
2. “Viable systems maintain equilibria behavior only by multiple contact with whatever lies outside themselves” (Beer, 1966, p. 257).
3. “It is characteristic of a viable system that all its parts may interact; not indeed to the extent that all possible permutations of all possible parts with all other possible parts must manifest themselves, but to the extent that subtle kinds of interaction drawn from all these permutations can and do take place” (Beer, 1966, p. 257).

Beer summarizes these three attributes of a viable system as the systems innate complexity, complexity of interaction with the environment, and complexity of internal connectivity (Beer, 1966).

The structure of a project system can be analyzed by the use of modeling. “Models are more than analogies; they are meant to disclose the key structure of the system under study”

(Beer, 1981, p. 75). Beer (1981) suggests we look at the body as a model of a system where we have subsystems such as the heart and lungs. We have a body and we have understanding of it, but not necessarily the 'how it happens' part of things (Beer, 1981). The importance of the model is to allow the reader to understand how the project works as opposed to how the project is said to work (Beer, 1981). To reiterate, the VSM is intended as a diagnostic tool that can "map the exact organization onto the model, and then ask whether the parts are functioning in accordance with the criteria of viability, as these have been set forth in neurocybernetic language" (Beer, 1981, p. 7). The mapping does not create an organizational chart for the project, but a framework of analysis of the viable functionality of the project as a whole. The variety of roles required of the viable system is now seen spread throughout the activity as compared to a hierarchical model. The VSM can be used to map the project or organization into Five Systems and six primary communication channels. The following sections look at the origins of the VSM.

## **ORIGINS OF THE VSM**

The Viable System Model (VSM) developed by Stafford Beer is explained by describing the conceptual components that make up the model and the relationship to how these components form the model. As modern management has developed so too has the complexity of the organizations that need to be managed (Beer, 1981). The desire to gather and maintain all the data in one huge database to be used by managers to make the best decisions is often perceived as the way to manage (Beer, 1981). What is really needed is a control system for change where the manager is the instrument of change (Beer, 1981). The study of control science is the basis of cybernetics which is the science of communication and control through which

management makes decisions (Beer, 1981, 1985). Cybernetics is the science of effective organization (Beer, 1985). With the increase in available data, the interface between man and machine (computers for example) has become more complex. Cybernetics offers a managerial methodology for the management of complex control requirements within an organization (Beer, 1981). Management is the profession of regulation, “and therefore of effective organization, of which cybernetics is the science” (Beer, 1985). To understand the concepts of cybernetics and the modeling accomplished by using the VSM, one must understand the language that describes the decision making process. The principle of control requires that the controller is part of the system that is being controlled (Beer, 1981, 1985). The controller is part of the system as it is and develops within the system as it evolves; it is not something that is attached to the systems, but rather part of the system architecture (Beer, 1981).

Understanding how the system is stimulated, and how the system is made aware of this stimulation, is important in describing how the system is to be controlled. Stimulation of the system is how the operation of the system is changed; whether the system accepts the stimulation for the better or rejects it due to its disruptive behavior are both important aspects for the manager to be able to be aware of, and in control of, within the system (Beer, 1981). The mechanisms to allow the manager to be aware of changes and the effects within the organization are important aspects of the control of the system (Beer, 1981). “Control is what facilitates the existence and the operation of system” (Beer, 1981, p. 27). The control of the system affects the internal stability of the system (Beer, 1981). The manager needs to have a control system that has “a way of measuring its own internal tendency to depart from stability, and a set of rules for experimenting with responses which will end back to an internal equilibrium” (Beer, 1981, p.

27). The stability pertains to not only known stimuli but the unknown events that occur to the organization as well (Beer, 1981). The system design should be designed to allow the system to maintain stability in a complex environment where not all variables are known. In cybernetic terms, ultra stability is when a system can survive arbitrary and un-forecasted interference (Beer, 1981). Anything within a system that can register and classify the existence of a stimulus is known as a sensorium (Beer, 1981). Within this area, a decision is made that compares the outcomes of making either choice against its criterion of stability (Beer, 1981). This is where there must be a mechanism that registers something has happened and is able to translate it into terms that have meaning to the control so that it understands the stimulus and can react accordingly (Beer, 1981). This detection is made within the system as this device is part of the systems not the stimulus itself (Beer, 1981). The 'bringing across' of the stimulus into the system is defined as the transducer (Beer, 1981). The Sensory Input Channel (SIC) is the channel along which this information flows to bring the information into the system (Beer, 1981). The Motor Output Channel (MOC) refers to the effects (output) caused by the stimulus (Beer, 1981). It is this function of input and output that reflects the balance of input and output. When large numbers of input stimulus and the associated outputs are produced they are often grouped together; as each individual input output is too complex and exponential in number to describe (Beer, 1981). This network or area of inputs/outputs within a system can be called reticulum and the variety of reticulum in cybernetics is called anastomotic (Beer, 1981). Anastomotic refers to the fact that many branches of the network intermingle to such purpose that it is no longer possible to sort out quite how the messages traverse the reticulum (Beer, 1981). The idea is similar to understanding that if you add a bucket of water to the tub, you know that the tub has

more water in it than before the water was added, but you don't know exactly where it is in the tub, nor is it deemed important to the overall description as to the amount of water in the tub (Beer, 1981). Another analogy is the understanding of our heart within our own body. We know our heart is there but we don't consciously control it, but we know it's being controlled by our body.

Stability of a system is to be designed into the system (Beer, 1981). Stability is "a self-regulating mechanism which does not rely on understanding causes of disturbances but deals reliably with their effects" (Beer, 1981, p. 34). This begins to help describe the term feedback which is an adjustment to the input so that the existing transfer function determines a corrected output within the system (Beer, 1981). The pattern of the output as described by a plot of all the inputs over the range is this transfer function. Beer stated that "negative feedback corrects output in relation to fluctuating inputs from any cause. It does not matter what noise gets into the system, how great it is compared to the input signal, how unsystematic it is, nor why it arose. It tends to disappear" (Beer, 1981, p. 36).

There are three fundamental components of the control system: an input setup, an output setup, and the network that connects the two together (Beer, 1981). An input arrangement may be a set of receptors which transmits information about some external situation into the affective channels, and concludes with a sensory register (or sensorium) on which this information is collected (Beer, 1981). The capacity to distinguish detail at each end of the input arrangement should be equivalent in efficient systems (Beer, 1981). The capacity to transmit the information between receptors and sensorium must be sufficient to take the traffic (Beer, 1981). This needs to occur for the output arrangement – the second component of the control system (Beer, 1981).

The third part is the anastomotic reticulum which connects the sensory to the motor plate (Beer, 1981). This means that there needs to be the same capacity to generate the inputs as there is on the output area for the outputs to go (Beer, 1981). This balancing of the control systems creates the desirable stability the manager seeks; it is the management of complexity (Beer, 1985). In cybernetics, the number of distinguishable items is called the 'variety' (Beer, 1981, p. 41). "Variety is a measure of complexity, because it counts the number of possible states of a system" (Beer, 1985, p. 41). In cybernetics terms then the input variety of the system as a whole must equal the output variety of the system as a whole to maintain a state of stability. This is an application of Ashby's Law of Requisite Variety which states "that control can be obtained only if the variety of the controller (...range of the controller) is at least as great as the variety of the situation to be controlled" (Beer, 1981, p. 41). To understand the importance of variety one must understand the scale to which variety can proliferate within a system; it often is exponential (Beer, 1981).

The scale of variety within the system and from nature can be enormous, but managers still need to choose effective solutions and reduce the variety for decision making (Beer, 1981). "We may devise variety-generators in control mechanisms, just as nature disposes variety-proliferators in proposing problems of control" (Beer, 1981, p.45). Variety that is reduced to a set of possible states is referred to as attenuated variety (Beer, 1985). "The real problem of control, the problems which a brain is needed to solve, is the problem of connecting an input pattern to an output pattern by means of an anastomotic reticulum" (Beer, 1981, p. 46). We must understand that there is a fundamental degree of uncertainty in nature already (Beer, 1981). This



added to needed decision making by managers contributes to the complexity of managing an organization.

“There’s a capability inherent in natural systems to self-organize the anastomotic reticulum in ways in which we do not properly understand” (Beer, 1981, p. 52). To help distinguish these two terms they needed to be defined: algorithm and heuristic. “An algorithm is a technique, or a mechanism, which prescribes how to reach a fully specified goal” (Beer, 1981, p. 52). Examples include a flight path for pilots, a math formula for calculation area, and the program a programmer has set up on a computer. “An heuristic specifies a method of behaving which will tend towards a goal which cannot be precisely specified because we know what it is but not where it is” (Beer, 1981, p. 52). “These two notions are very important in cybernetics, for in dealing with unthinkable systems it is normally impossible to give a full specification of a goal, and therefore impossible to prescribe an algorithm. But it is not usually too difficult to prescribe a class of goals, so that moving in some general direction will leave you better off (by some criterion) than you were before. Instead of trying to organize it in full detail, you organize it only somewhat; you then ride on the dynamics of the system in the direction you want to go” (Beer, 1981, p. 53). “These two techniques for controlling a system are dissimilar...we tend to live our lives by heuristics and try to control them by algorithms” (Beer, 1981, p. 53). It’s like making plans to a destination and then trying to get there. Beer points out 13 points to be made about heuristic controls (Beer, 1981, pp. 54-57):

1. An heuristic will take us to a goal we can specify but do not know, and perhaps cannot even recognize when we reach it.

2. If we give a computer the algorithm which operates the heuristic, and wait for it to evolve a strategy, we may find that the computer has invented a strategy beyond our own ability to understand.
3. This being the case, it is time to start recognizing the sense in which man has invented a machine 'more intelligent' than he is himself.
4. 'Computers can do only what they are told' is correct, but highly misleading.
5. The argument that the output of a computer is only good as its input, summed up in the phrase 'garbage in, garbage out....is true for algorithms specifying algorithms, but not for algorithm specifying heuristics.
6. The mechanism we are using is precisely the old servomechanism discussed much earlier, in which error-correcting feedback is derived by a comparator from actual outcomes contrasted with ideal outcomes. But the outcome is measured, not in terms of the input data transformed by a transfer function, but in terms of the whole system's capacity to improve on its results as measure in another language.
7. The servomechanism's feedback does not operate on the forward transfer function as such. It operates on the organization of the black box which houses the transfer function. It experiments with the connectivity of the anastomotic reticulum. As effective structure emerges, this is what cuts down the capacity to proliferate variety.
8. Feedback dominates the outcome still holds. Hence everything depends on the other-language criteria which the system is given to decide what to learn and what to unlearn.

9. There must be another control system, using the output of the first system as input, and operating in another plane. This higher-order, other language system would experiment with the fluctuating outputs of the first system, and produce new outputs in the other plane. Feedback from there (compared with some other-plan criteria) would establish the meaning of 'better' or 'worse' for the first system.
10. The second system needs a third system to evaluate its outputs in a higher-order language, and to say what counts as more or less profitable. This third system would experiment heuristically with the time-base of the second system's economic evaluations.
11. This argument continues until the hierarchy of systems, and the levels of language that go with them, reach some sort of ultimate criterion. It can only be survival.
12. And what is true of the firm in this generation of management, and true of this man, son of his father, becomes true of the firm as a continuing entity in perpetuity, and of all man, fathers of their sons. The training process for here and now is the evolutionary process for the epochs ahead.
13. So when we said that a heuristic organizes a system to learn by trying out a new variation in its operation control strategy, we might equally have said that a heuristic organizes a family of systems to evolve, by trying out a new mutation in its genetic control strategy. The aim of adaptation is identical.

What this sets up is a meta-language - a language of a higher order in which propositions written in a lower order language can be discussed (Beer, 1981). Virtually any language must contain propositions whose truth or falsity cannot be settled within the framework of that language of

which logical paradoxes are the familiar example (Beer, 1981). These propositions will then have to be discussed in the meta language, at which level we understand what is paradoxical about them (Beer, 1981). “Activities can create an algedonic mode of communication between two systems which do not speak each other’s language” (Beer, 1981, p. 59). This is used to translate between the two systems. Errors in communication occur. The vital point is that mutation in the outcome is not the absolute enemy we have been taught to think, it is a precondition of survival (Beer, 1981). The flirtation with errors keeps the algedonic feedbacks toned up and ready to recognize the need for change (Beer, 1981). The systems’ errors are wasted as progenitors of change, and change itself is rarely recognized as required (Beer, 1981). “All the managerial emphasis is bestowed on error-correction rather than error-exploitation” (Beer, 1981, p. 62). Errors themselves are reiterated and are deemed as being essentially bad (Beer, 1981). “Thus it follows that when change is really understood to be necessary, people resist the need, because to attempt to change is automatically to increase the error rate for a time, while the mutations are under test” (Beer, 1981, p. 62). “We use organizational charts that are really devices for apportioning blame when something goes wrong. They specify ‘responsibility’ and the ‘chain of command’, instead of the machinery that makes the firm tick” (Beer, 1981, p. 75). “Models are more than analogies; they are meant to disclose the key structure of the system of study” (Beer, 1981, p. 75). If we want to understand the principles of viability, we had better use a known-to-be-viable system as a model. It turns out our body is a familiar analogy to the model and will be used in describing the VSM (Beer, 1981, p. 76). “Once the issues are properly understood, there will be no real need to remember the details” (Beer, 1981, p. 77).

An overall description of a model development could be described in three phases: the description phase, prescription phase, and the breakout phase (Beer, 1981). In the description phase the knowledge of how the organization is divided is presumed and is then articulated in the model description (Beer, 1981). The prescriptive phase writes the principle operation relationship down on paper, and the final breakdown phase is where the formal statement of the organizations structure is written down (Beer, 1981). It is important to write down what jobs need to be performed verses just the person to do the job, as the task and the interrelationships are the items that need to be captured. How ‘input will be converted to output’ needs to be captured in this modeling process for the model to truly represent the intended organization (Beer, 1981).

It still holds true today that control in a business “has to do with the information of an extent and complexity beyond the capacities of those senior people to absorb and interpret it. It has to do with the structure of the information flows, with the method of information handling, with the techniques for information reduction, and so forth. All these features of information’s role used to be determined by the cerebral capacities of the senior staff” (Beer, 1981, p. 80). “There exists today a capacity to cope with information vastly in excess of the human capacity, with the result that the manager is no longer the arbiter of sophistication in control. He must delegate this role to the electronic computer” (or the information available and presented) (Beer, 1981, p 80). The manager has to organize the team and information flow. The need for a new language to be used with VSM differs from the hierarchical models and languages often used in representing organizations (Beer, 1981). The language associated with the VSM differs and hence enables better articulation of the model proposed as opposed to using the language

associated with the hierarchical model. “We are constrained by our own experience as well as informed by it” (Beer, 1981, p. 82). “We have a managerial culture in which some things, distinctively modern, cannot be expressed although we know them” (Beer, 1981, p. 82). The purpose of modeling has different perspectives from different people (Beer, 1981). A model’s scaling down to transfer the functions to a more manageable size allows workability in describing an organization that is complex (Beer, 1981, p. 83). A good model is one that is appropriate and one is able to learn something about the thing that is being modeled (Beer, 1981, p. 84). Beer presents that the self-reproduction of a viable system is usually thought of as the outstanding characteristic of that viable system, but it is continuous and regenerative self-production that is an underlying characteristics of its identity (Beer, 1985). These are the characteristics of a learning organization.

“The criticism of the organization chart as a model of a firm is that it is not appropriate as modeling those aspects of the firm we most wish to understand – which have to do with control” (Beer, 1981, p. 84). The organizational chart was never intended for control anyway (Beer, 1981). If you want to look how control is accomplished in an organization it makes sense to use a control system as a model (Beer, 1981). Control systems are the topic of study of the science of cybernetics (Beer, 1981). “The trouble is that control systems of sufficient complexity to serve as adequate models of the firm are themselves so complicated that cybernetics does not fully understand them – except through models” (Beer, 1981, p. 84). “Cybernetics is actually done by comparing models of complex systems, with each other and seeks the control features which appear common to them all” (Beer, 1981, p. 84). The VSM seeks to learn about the structure of control in complex systems. “That would mean deriving a model of a complex

system in which control was already recognized as highly successful. Such a system could teach us about structure, provided that the rules of the modeling were followed carefully (Beer, 1981, p. 85). “Scaling down, transferring, and investigating workability in an appropriate description would be essential, but the cybernetician is used to doing this job” (Beer, 1981, p. 85).

The VSM is based from a neurocybernetic model with similarities of the way an organization is controlled (Beer, 1981). The modeling after the human nervous system is also very familiar to many. “A useful model must be able to handle the differences in scale, transference, workability, and appropriateness in convincing style” (Beer, 1981, p. 87). The “Neurocybernetic model pursues and hunts down organizational invariances in large, complex, probabilistic systems within the methodology of model-building” (Beer, 1981, p. 87). Invariance is when one thing is invariant with respect to something else; does not change as the other thing changes (Beer, 1981, 1985). Invariant in this case is a factor in a complicated situation that is not affected by the changes surrounding it (Beer, 1985). “There are invariant rules governing such a system, which is derived from the theory of probability and expressed mathematically. It does not matter whether we are dealing with a brain or a firm” (Beer, 1981, p. 87). Within the VSM information within the model needs to be inspected to see whether the information coming up is appropriately dealt with at specific levels (Beer, 1981). A modification of the information is passed on and upwards according to the rule sets instilled into the organization (Beer, 1981). There is a filtering of information within a model as the variety or amount of information must be reduced or amplified to adequately manage the levels within the model of this organization (Beer, 1981, p. 93). A filter is a variety reducer, which acts as an attenuator for variety (Beer, 1981, p. 94). “There has to be a central command axis, and specialized controllers have to be

integral to it – even if they are operating in a different mode...they all have their tasks to be performed” (Beer, 1981, pp. 95-96):

1. Testing incoming data and recognize any on which command action should be taken; taking the action, and send on the original information, suitable modified.
2. Test and recognize any data which have to be filtered at this level, compressing, facilitating, and inhibiting the ascending path (handling the data at this level).
3. Store a record of these transactions, in case details have to be retrieved.

We are confronting what seems to be a five-level hierarchy of systems contained within a major computer configuration....five being somewhat arbitrary (Beer, 1981, p. 98). “All five systems are serially arranged along the vertical command axis of the firm, and they model the somatic nervous system of the body” (Beer, 1981, p. 98). “The middle three of the five are divided out of the cord and the brain stem (Beer, 1981, p. 98). “The cord itself is at the lowest level, the medulla and pons are grouped together next” (Beer, 1981, p. 98). The third of the three echelons is the diencephalon along with the thalami and basal ganglia (Beer, 1981). You see two sub-systems when looking at the outer part of the five sub-systems: the lateral axis which mediates afferent and efferent information and the cerebral cortex itself (Beer, 1981). The upper level creates a homeostasis of stability of its system one’s environment, despite each of the systems having to cope with the unpredictable external environment (Beer, 1985). “What matters to the firm’s top management is not so much the ‘facts’ as ‘the facts as presented’, and the presentation chosen can govern the outcome of even the most important and well considered decision” (Beer, 1981, p. 98). “Just as the cerebral cortex is not in direct touch with peripheral events at all, but



receives only such data and in such form as the subordinate echelons pass on, so top management should be presumed to be isolated from actual events” (Beer, 1981, p. 98).

“The exteroceptors are looking outward at captured information from the outside world” (Beer, 1981, p. 100). “Telereceptors work at a distance to see whatever functions are responsible for example: examining markets, economic conditions, and the credit-worthiness of customers” (Beer, 1981, p. 100). There are chemical and cutaneous receptors as well that are all analogous to any kind of data-logging signal in a distant production plant (Beer, 1981). The receptors are there to detect delicate situations that may be arising (Beer, 1981). The idea of this is to describe how information is detected and retrieved at the lowest level within the VSM and analogous to the human nervous system; this information is collected and disseminated along the lateral axis (Beer, 1981). “The cortex, we said, has to do with intellect; it is the seat of consciousness. Its functions are incredibly complex, but they seem concerned with one thing: pattern” (Beer, 1981, p. 102).

“Large areas of complex organizations should be autonomous” (Beer, 1981, p. 103). Autonomous means that the branch or function indicated is “responsible for its own regulation” (Beer, 1981, p. 103). “The autonomic function is essentially to maintain a stable internal environment” (Beer, 1981, p. 103). “Autonomic control must correct imbalances to the internal environment; the first necessity is to detect the change; receptors then alter their state, transducing the change into efferent impulses which then go to the control center” (Beer, 1981, p. 103). “The impulses are then computed and associated adjustments are made through the motor part of the system (the autonomic reflex)” (Beer, 1981, p. 104). Hierarchical control is “not the only dimension of control” (Beer, 1981, p. 105). “The main pathways up and down the

central command axis are used to inter-relate the activities of the different departments and functions within the total plan” (Beer, 1981, p. 105). “If the managers in the line kept everyone fully informed with details, the major planning networks would become overloaded” (Beer, 1981, p. 107). “There is a complete society of peripheral management, which operates for the most part at the social level, and whose control language is not hierarchical in the sense of the line command, but informational” (Beer, 1981, p. 107). The internal balance within the organization has a goal of a general homeostasis (Beer, 1981, 1985). There can be checks and counter-checks to maintain stability and the conscious and unconscious processes are put in place for stability (Beer, 1981). “For the management scientist, the model provides the bridge between practical problems of control in the enterprise, and apparently too simple, too analytic, too demanding computable models of servomechanisms” (Beer, 1981, p. 113). “In autonomic control, a basic operational system and a basic set of instructions are taken for granted and then proceeds to keep what is happening in balance and in economic health. Of course consciousness can take control when it wishes” (Beer, 1981, pp. 116-117).

Stafford Beer has created the VSM system out of five systems and six primary channels that are part of the VSM (Beer, 1981, 1985). The description and characteristics of these components were used and were the basis of the framework that was used in the analysis of project management system for this research effort. After examination of the criticisms of the VSM, the following sections describe the details of the model components and help to articulate the characteristics as functional parts of the VSM.

## CRITICISM OF THE VSM

No model or methodology for diagnosing organization systems goes without criticisms; the VSM is no exception. One argument suggested for the lack of wide spread use of the VSM is “largely due to the theoretically daunting manner in which the model has been presented, and the lack of practical, easy to follow, case studies focused on business organisation” (J. Brocklesby and S. Cummings, 1996, p. 49). Espejo and Harnden (1989) describe two more limitations they’ve encountered with the VSM in the following paragraphs.

Two limitations of the VSM are discussed in “*The Viable System Model: Interpretation and Application Stafford Beer’s VSM*”. The first limitation is that “people may be the basic elements of a so-called viable system under the VSM rubric” (R. Espejo and R. Harnden, 1989, p. 20). The limitation suggests that because people are said to have ‘free will’ but it must also be realized that people also have constraints (R. Espejo and R. Harnden, 1989). People vary due to their experiences for example, but for the VSM, what matters is the functioning of the element under which constraints are agreed to while fulfilling a job for example (R. Espejo and R. Harnden, 1989). The second limitation relates to the “possible inheritance of acquired characteristics in the individual” (R. Espejo and R. Harnden, 1989, p. 21). People and society have characteristics. “Therefore a major difference emerges as between the VSM of an individual and the VSM of society to constitute, at least at first sight, a limitation of the model” (R. Espejo and R. Harnden, 1989, p. 21) . This is worked out by the requisite variety attenuation and filters between recursive levels of the VSM (R. Espejo and R. Harnden, 1989).

Ron Ananderton claims the need for “more formal development of the model” (R. Espejo and R. Harnden, 1989, p. 40). Ananderton points to the people portion of the VSM where he

explains that “Human behavior transcends rules. Human’s make rules, sometimes they break rules” (R. Espejo and R. Harnden, 1989, p. 47). Ananderton’s description of the VSM’s use of ‘wiggles’ to describe complex situations (in such a simplistic manner) raises issues of credibility of the model itself (R. Espejo and R. Harnden, 1989). M.C. Jackson comments, as viewed in (R. Espejo and R. Harnden, 1989), suggest another criticism of the VSM of ‘subjective judgment’ of decision makers as being acceptable within the VSM (R. Espejo and R. Harnden, 1989). It is suggested that the use of the VSM “serves the purpose of narrow elite group” due to its “perceived autocratic implications (Rivett, 1977, Checkland, 1980; Adams, 1973)” (R. Espejo and R. Harnden, 1989, p. 482). Irrespective of these and other criticisms, the VSM has managed to persist over several decades since its inception.

## **APPLICATION AREAS OF THE VSM**

The VSM as developed by Stafford Beer (1981, 1981, and 1985) has been used extensively in many different application areas around the world. Applications have centered on organization structures and how to diagnose, develop, or reorganize from a cybernetics perspective. In the following development, examples of the global application of the VSM area are discussed.

*Designing a Viable Organization* (J. Brocklesby and S. Cummings, 1996) talks about the usefulness of the VSM as “a tool for anticipating, planning for, and implementing large scale organizational change” (J. Brocklesby and S. Cummings, 1996, p. 49). The model was used “as part of a research and consultancy intervention with Telecom (NZ) Limited during a period of extensive reorganization and downsizing” (J. Brocklesby and S. Cummings, 1996, p. 49). The

authors determined that the “VSM framework provides a useful tool for thinking about the workings of any system, particularly business organizations” and “provide a pictorial representation” to organizational questions (J. Brocklesby and S. Cummings, 1996, p. 51). The authors summarize and state the VSM “provides a common framework that allows one to capture organizational idiosyncrasies, each organization’s systemic strengths and unique weakness” (J. Brocklesby and S. Cummings, 1996, p. 51).

“*Designing Freedom, Regulating a Nation: Socialist Cybernetics in Allende’s Chile*” (E. Medina, 2006) examines the history of ‘Project Cybersyn’. This was a project that developed “an early computer network...in Chile ... to regulate the growing social property area and manage the transition of Chile’s economy from capitalism to socialism” (E. Medina, 2006, p. 571). Medina points out that “Beer recognized that his cybernetic toolbox could create a computer system capable of increasing capitalistic wealth or enforcing fascist control” (E. Medina, 2006, p. 599). This is an example where the cybernetic use of the VSM could be used as a political tool for monitoring and controlling a nation.

Another unique article, “Design for viable organizations: The diagnostic power of the viable system model” by Markus Schwaninger (2006) set out to document five applications of the VSM. The five cases were:

1. Transformation of a Swiss insurance company.
2. Redesign of a meta-system for Aditora Abirl – a company famous for journals, magazines, and travel/cultural books.
3. Enhancing a small chemical corporation, Togo, from three separate companies into one.

4. Developing a strategy for health Services Company: Kur- und Klimikverwaltung Bad Rappenau.
5. Examining the corporate ethos of the national auditing institution of the Republic of Colombia: Contralia de la Republica.

The interesting significance of this article was that they were using case studies at the organizational level as their research method. The author states “VSM has proved to be an extraordinarily instrument. It not only enables a better understanding of the cases under study, but it facilitated the work enormously” (M. Schwaninger, 2006, p. 965).

And finally there is an example of VSM being applied to the health care services area. “Improving Practice: A systems-based methodology for structural analysis of health care operations” by Charles Keating (2000). This article introduces a systems-based methodology for conducting analysis of organizational structure for health care operations. The methodology enlightened higher orders of learning through structural inquiry. Several contributions to this methodology provided included a better method of understanding the organizations identity, an analysis that supports establishing priorities for structural improvements, decision support for better utilization of resources, and identification of its use across a wide range of applicability for structural analysis of other organizations within context (Keating, 2000).

The preceding examination demonstrates how the VSM has used as an organizational analysis tool in a variety of applications areas to include: organizational structural change within corporations, government organizational reform, insurance services industries, chemical corporations, auditing institutions, and health care service industries. The following sections explain the systems and channels integral to the VSM.

## **SYSTEM ONE**

The System One (the productive function) as described by the VSM is related to the operational units of the organization that deliver the product or service that the organization is built around. An element of control in this area centers on the detection of patterns of achievement that can be reported through System Two (coordination) to the organization (Beer, 1981, pp. 171-172). System One is embedded in a meta-system, which is in fact an operational element of another system at a higher level of recursion (Beer, 1981, 1985). The set of embedded productive functions is known as the System One of the System-in Focus (Beer, 1985).

“System One must produce itself. This is the one criterion of viability that everyone seems to accept. It means that the existing enterprise has to go on being itself...the investment required to enable System One to produce itself is mandatory” (Beer, 1979, p. 254).

Figure 7 below shows the VSM with Operational units of System One identified. The meta-system is highlighted to focus on operations and management areas.

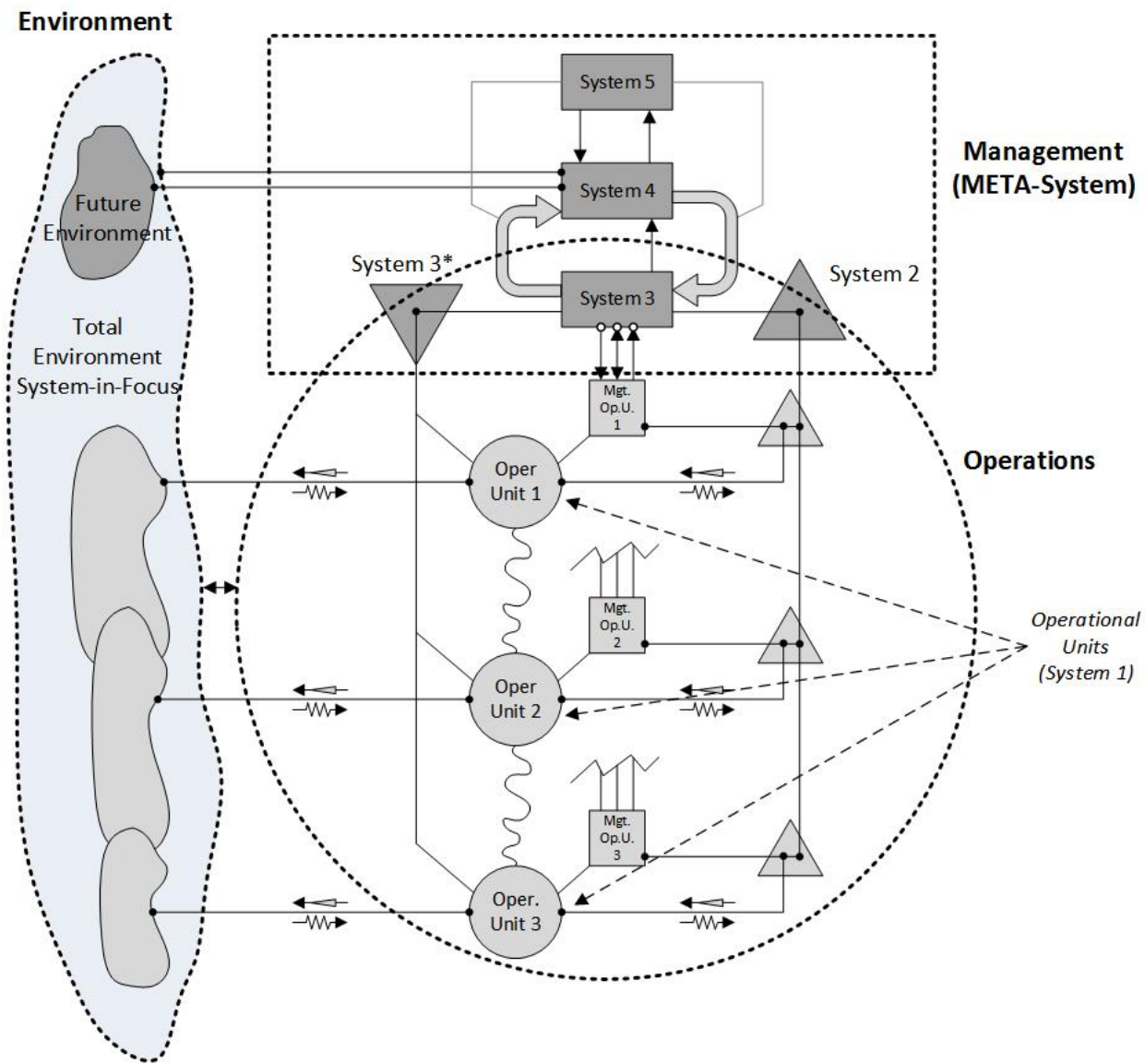

**Figure 7: VSM with Operational Units Noted {Adapted from Ríos, 2012, p. 26}**

System One is responsible for the production and delivery of organizational goods and services to the environment (Ríos, 2012). System One is made of operational organizational units (each of which is a complete viable system), each of which is responsible for an activity or product (Ríos, 2012). The other units play a supportive role and are non-viable regulatory units;



that is to say they are unable to exist independently outside of the organization, unlike System One units (Ríos, 2012). The following describes the relationship between System One and the other units (Ríos, 2012):

1. With corporate management (System 3) via the three kinds of fundamental relations represented by “receiving instructions and guidelines”, “accountability”; and “resource bargaining”.
2. With its specific environment comprising, amongst others, its market or the addresses of the services offered by the unit.
3. With its regulatory unit (System Two).
4. With the auditing function (System 3\*: Specific information channel).
5. With the operational units (System One components).
6. With the various managements of the operational units.
7. With the metasytem via algedonic channel.

System One controls execution in response to policy directives and overriding instructions from above in response to the environment and other divisional needs (Beer, 1981, p. 167). The metasytem (in its role as operational element of the next level of recursion) may know something affecting oscillatory behavior of our System One that is not seen by System One (Beer, 1979, p. 182). System One is seen as the operational level of a project.

## **SYSTEM TWO**

System Two acts as “an elaborate interface between Systems One and Three” whose purpose is to prevent uncontrolled oscillation between these operations areas (Beer, 1981, pp.

172-173). “System Two is logically necessary to any viable system, since without it System One would be unstable – System Two would go into an uncontrollable oscillation” (Beer, 1979, p. 177). This back-and-forth disagreement between operation units over resources and procedures is an example of this oscillation that is to be mitigated through the System Two functional areas. “The viable system engages the services of System Two to cut down the variety of its operational interaction insofar as they are inherently oscillatory – and *only* to that extent” (Beer, 1979, p. 177). “System Two is not dedicated to the performance of routine procedures of whatever kind, but only to those routines that are anti-oscillatory” (Beer, 1979, p. 184). This is important to distinguish as System Two is cybernetic discovery (Beer, 1979):

1. Although every enterprise dedicates much effort to anti-oscillatory activity, under all manner of guises, there is no orthodox managerial correlate available to match it.
2. System Two failures are extremely common – to be corrected it must be understood that this whole question of oscillatory behavior is endemic to System One, and of System Two as antidote.

Viability is the ability of a system to maintain a separate existence and depends on a number of necessary conditions (Beer, 1979). System Two’s main role can be seen to prevent oscillation within the System One- System Three areas. It is also an amplifier of the self-regulating capacity of the units themselves (Ríos, 2012). Examples of System Two are (Ríos, 2012):

1. Information systems.
2. Production planning or task programming tools.
3. Knowledge basis.
4. Accounting procedures.

5. Diverse types of operational norms intended to provide behavior standards.
6. Activities associated with personnel policies, accounting policies, the programming of production and operations, and legal requirements.

The System Two mechanism deals with the transmission of information which is taken from the operational units and once filtered, forwarded by the central regulatory unit to System Three (Ríos, 2012). System Three will then decide whether or not to act as a function of the information provided from System Two (Ríos, 2012). The System One's communicate with their associated System Two to update the upward channels of their operational status, its System Two collective role is to filter and forward to System Three the needs and balance the System Ones.

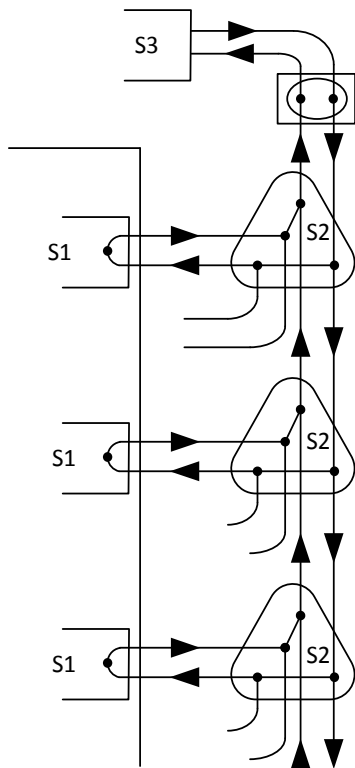

**Figure 8: System Two (S2) {Adapted from Beer, 1981, p. 173}**

Figure 8 above shows the System Two portion of the VSM. It is here where the anti-oscillatory actions occur between the System One's.

### **SYSTEM THREE**

System Three is “the highest level of autonomic management and the lowest level of corporate management” whose purpose is to “govern the stability of the internal environment of the organization” (Beer, 1981, pp. 175-176). It is here in System Three where routine

information about the internal regulation is available to System Four. Systems Three characteristics include the following (Beer, 1979, p. 202):

1. It surveys the total activity of the operational elements of the enterprise.
2. It's is aware of what is going on inside of the firm in the current state.
3. Direct links with all managerial units – real time.
4. It's aware of the System Two – its own subsystem.

Figure 9 below highlights Systems Three, Three\* (Star), Four and Five:

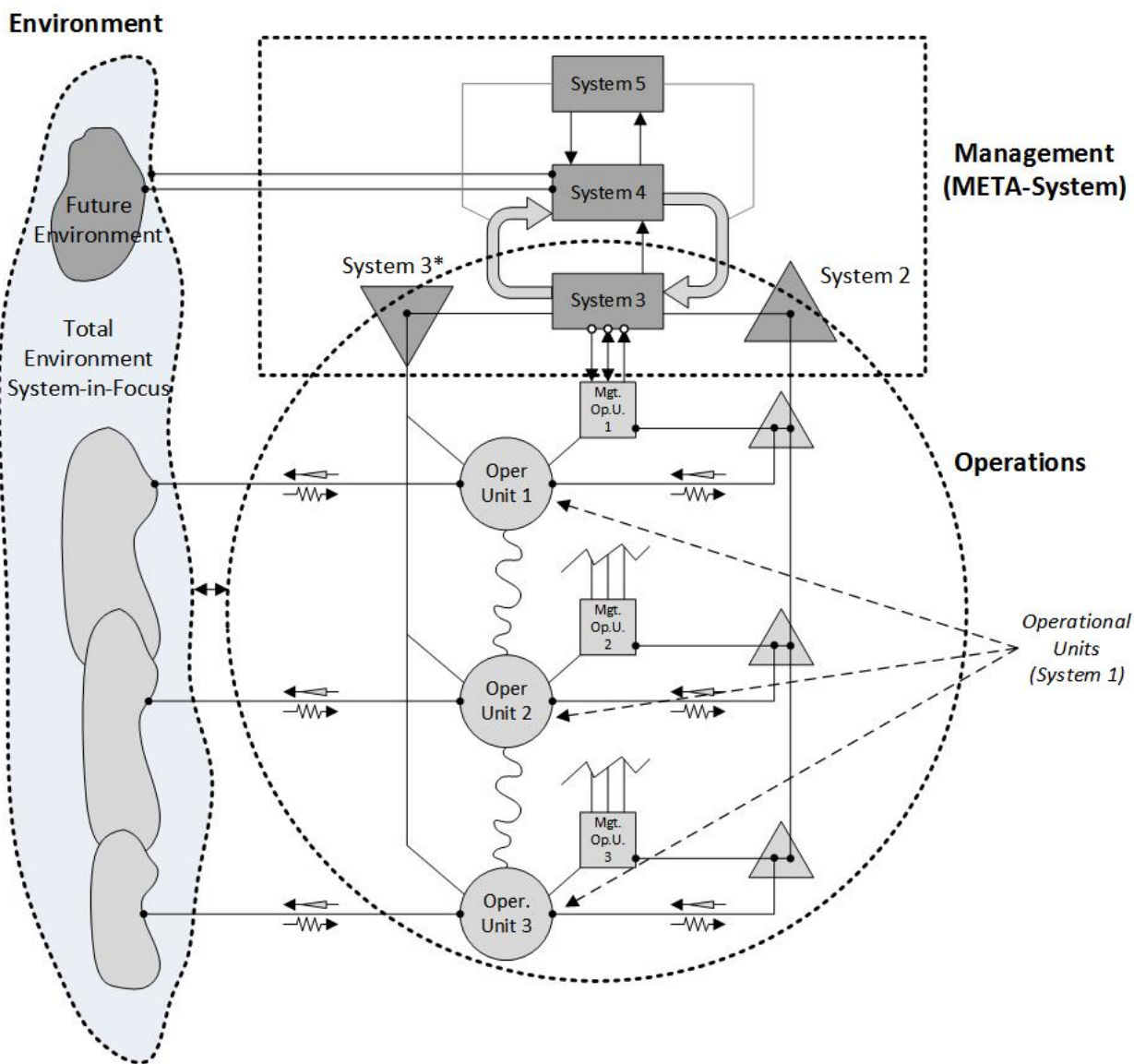

**Figure 9: VSM Highlighting Systems 3, 3\* (Star), 4, and 5 {Adapted from Ríos, 2012, p. 26}**

System Three is usually handled by corporate executives since they are positioned to have the time to overview without the operational concerns of the working division level personnel (Beer, 1979, p. 203). “Common services that contribute to synergy are always System Three functions”

(Beer, 1979, p. 204). System Three has the task of managing the set of operational units comprising System One sometimes being referred to as the “Operational Management” of the organization (Ríos, 2012). System Three is fundamentally interested in the ‘here and now’ (Ríos, 2012). It should always be remembered that the direct involvement by the vertical line of authority has to be limited to special circumstances so as not to jeopardize the autonomy of the operational units which need this autonomy to directly absorb most of the variety generated in their specific environments (Ríos, 2012). Functions may include (Ríos, 2012, pp. 32-35):

1. Transmitting information from ‘management’ on aspects related to the organizations aim or purpose.
2. Information concerning the policies of the organization and operational instructions to the operational units.
3. Receives information on the organizations internal situation (includes the algedonic signals that give warning of extreme risk).
4. Modifying goals.
5. Changes needed in System One as suggested by System Four.
6. Negotiation of resources.
7. Should have fluid communication with System Four on functioning and opportunities/difficulties of modifying System One.

### **SYSTEM THREE \* (STAR)**

System Three \* (Star) is a support system for System Three getting information of the status of System One; information that does not follow the normal direct channel of communication (Ríos, 2012). The purpose of System Three \* (Star) is to ensure that the

information between System One and System Three is complete (Ríos, 2012). Information and activities include (Ríos, 2012, pp. 35-39):

1. Quality audits.
2. Opinion surveys.
3. Compliance with accounting procedures.
4. Work studies.
5. Operational research.
6. Surveys.
7. Special studies.
8. Information gathering techniques.

#### **SYSTEM FOUR**

“System Four can be described as the “development directorate of the firm” (Beer, 1981, p. 181). “System Four provides all the information to System Five, the highest level of decision making within the organizational unit” (Beer, 1981, p. 183). “System Four demonstrates recursive logic as it mirrors or maps the totality it serves by self-duplication” (Beer, 1981, p. 192). System Four’s principal responsibility is connected with the future and the external environment of the organization (Ríos, 2012). System Four is seen to expand variety by “contemplating rather than creating alternatives” and is able to reduce variety by “mental elimination of those alternatives” (Beer, 1979, p. 230). “We hope to acquire the degrees of freedom needed to promote mutation, learning, adaptation, and evolution (in a word survival-worthiness, or in another word VIABILITY) by *stimulating* the amplification and attenuation of variety” (Beer, 1979, p. 230). System Four activities may include research and development,



market research, corporate planning, and economic forecasting (Beer, 1979). These areas are constantly changing and in need of continuous attention.

“It’s quite normal, in a large enterprise, for the elements of System Four to have virtually no knowledge of each other’s activity” (Beer, 1979, p. 232) because: (1) each member is part of the staff of some other director or vice president; and (2) top people believe they are affecting the integration themselves. “The ‘integration’ of System Four entails an involvement between its elements at the level of their own variety generation” (Beer, 1979, p. 233). “Every regulator mechanism must contain a model of that system which is being regulated” (Beer, 1979, p. 234). Beer proposed using the model as a ‘screen’, to obtain the ‘focus’ that would manifest ‘integration’, exemplifying sound cybernetic underpinnings (Beer, 1979). System Four can be considered the ‘outside and then’ level (Beer, 1979). System Four perform the following actions to achieve its task or functions to be taken include (Ríos, 2012, pp. 39-46):

1. Make use of prospective study tools (example Delphi studies).
2. Scenerio analysis.
3. Sensitivity analysis.
4. Simulation modeling.
5. Operational room to make strategic and operational decisions.
6. Looking at the past, present, future and real-time data.
7. Development and innovation.
8. Market research; other research.
9. Prospective studies; projects.
10. Financial innovations.

## 11. Analysis of relations with the environment.

“System Four must be ready to handle the variety input generated by System Three and to design the attenuation filter that conveys that variety to System Five” (Beer, 1979, p. 238).

“System Four is the innovation generator that uses “existing channels and transducers through which to stimulate and interrogate the problematic environment” (Beer, 1979, p. 238). The unique design of the return channel is the difference in organizations. “Innovators devise new attenuating filters and new transducers, in order to understand the novelties which (by definition) they are not aware of in advance” referred to as feedback (Beer, 1979, p. 239).

System Four is designed to handle the regulation of the System Three environment of the System One operations environment and the larger organizational environment. An organization needs to invest in itself to ensure its own viability (Beer, 1979). System Four develops these areas where investments are advised. Investments in time, talent, care, and attention are needed (Beer, 1979). As most resources goes to the System One areas, the balance are divided primarily to System Three and System Four; again an area of resource completion. System Four uses its resources to expand its ability to absorb System Three variety by contemplating verses creating alternatives (Beer, 1979). System Four reduces variety here by the mental absorption of alternatives (Beer, 1979). Some elements of System Four that allow for the variety changes are from functions such as (Beer, 1979, pp. 230-231):

1. Research and Development.
2. Market Research.
3. Corporate Planning.
4. Economic forecasting.

## 5. Market Development.

These functional areas are typically dispersed amongst different areas of the organization and not centralized to one specific area (Beer, 1979). System Four's goal is to focus the goals for each of the functional areas to the goals of the desired organization (Beer, 1979). System Four then is able to have a model of the organization as it is 'now' and how the organization should strategically be 'then'. By comparing the elements of the models, System Four is able to make recommendations for changes (Beer, 1979). It's here where Beer (1979) says that every regulator must contain a model of that which is to be regulated. When two different models converge into one, learning is said to have occurred (Beer, 1979). System Four's goal is to make recommendations based on the functional inputs that would allow their individual models of the organizations goals to be merged into one organizational model to be called the corporate strategic model (Beer, 1979).

System Four has to manage the functional elements in their normal interactions with their environment as well as the larger environment (Beer, 1979). The focus area is called the kernel. "An Operations Room, considered as the physical manifestation of our focus – in which in particular the kernel of the System Four model of itself is displayed – might take on any form. But outstandingly it must be an ergonomically viable locale" (Beer, 1979, p. 243). System Four consists of people who spend the money that is made in System Three, the resource area (Beer, 1979). Beer states that synergistic behavior derives from the recognition of mutual support between the operational elements (Beer, 1979). Synergy as the sum is greater than the whole concept of aggregate productivity of constituents (Beer, 1979).

## **SYSTEM FIVE**

System Five is the highest decision point within the organization unit and forms the policy for the rest of the organizational unit (Beer, 1981). The power to balance the natural tension that exists between Systems Three - System Four resides in the equation of variety between System Three and System Four (Beer, 1981). System Five can delegate power, if the (four-principled) machinery associated with System Four is in place. Beer (1981, 1979) reiterates that variety absorbs variety. All that remains for System Five to do is monitor the regulatory machinery – to ensure that it does not embark on an uncontrolled oscillation (Beer, 1979). Recursiveness embraces the notion of local closure at any given level of recursion (Beer, 1979). Within any one viable system, System Five is the metasystemic administrator of Ashby's law (Beer, 1979). System Five is then seen to absorb the residual variety of the System Three - System Four interaction (Beer, 1979, p. 263). System Five representatives can be representatives of management, shareholders, investors, unions, potential workers, and project managers. System Five represent the identity of the project or organization. Responsibilities of System Five would include (Ríos, 2012, pp. 46-49):

1. Determining the vision, mission and strategic goals of the organization.
2. Monitoring organizations stability and internal equilibrium.
3. Ensure organization maintains its identify.
4. Manage stakeholders.

The four responsibilities are the major areas that System Five must perform as part of the defining identity of the system (project).

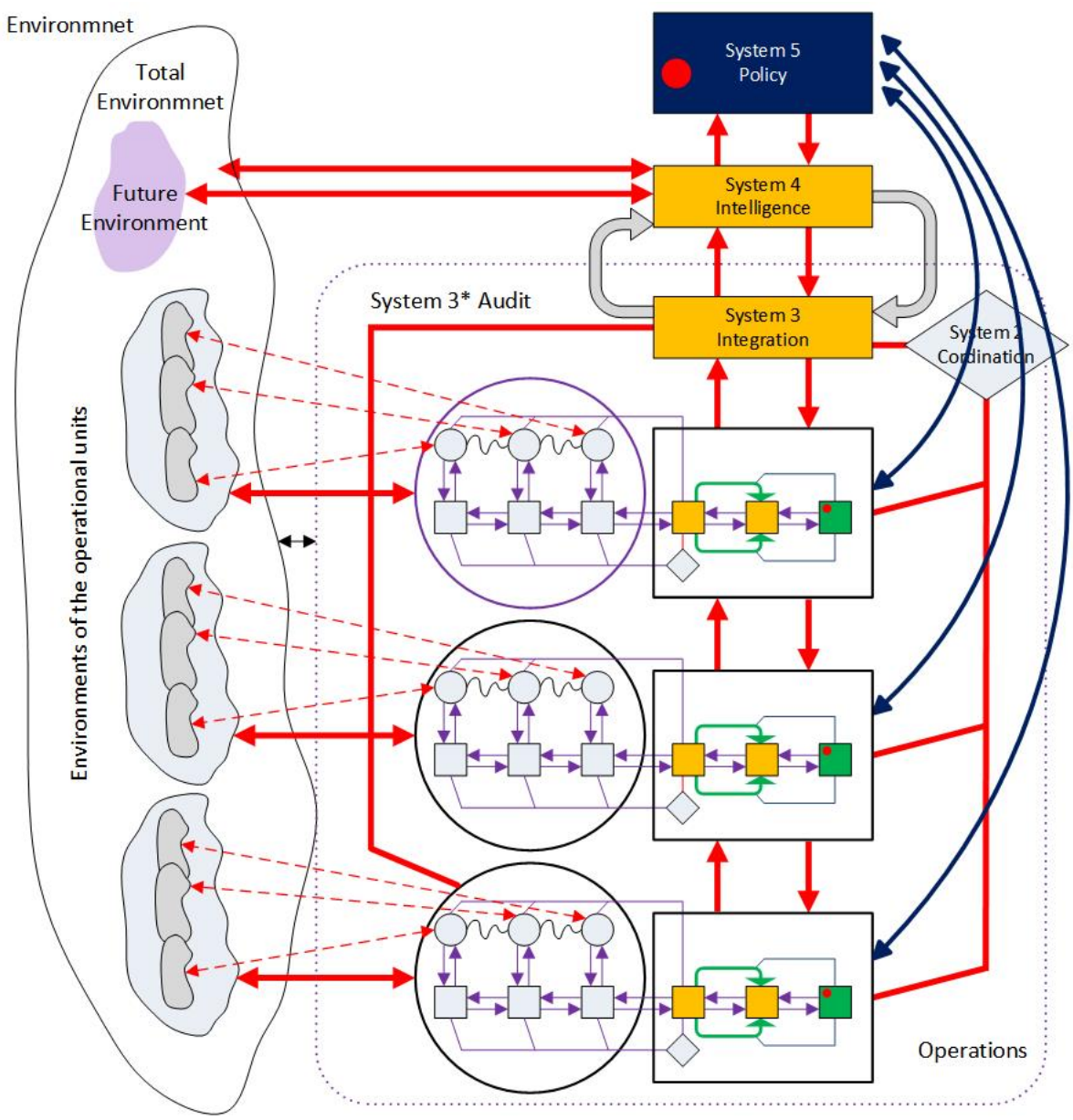

**Figure 10: VSM Showing System Five {Adapted From Ríos, 2012, p. 60}**

Figure 10 above also shows the recursive nature of the VSM as noted by the embedded VSM within the operations area.

## SYSTEM INTERACTIONS WITHIN THE VSM

When developing the foundations of the model, three divisions of management will be recognized that the “large part of their activity, perhaps eighty percent of it, is purely anti-oscillatory” (Beer, 1979, p. 180) as below:

1. Interventions on the vertical line from the metasytem to System One which constrain horizontal variety for legal reasons.
2. Interventions on the vertical line from the metasytem to System One which constrain horizontal variety for the sake of institutional cohesiveness, as judged from the *purpose* of the institution.
3. System Two activities, which are purely anti-oscillatory.

“The second proposal is that all documentation dealing with the accounting functions (1) and (2) should be distributed uniquely as a sign that they relate to mandatory interventions on elemental variety” (Beer, 1979, p. 181). “Without a System Four clearly in place, and with a System Five whose very nature is ambiguous, there is no System Three - System Four interaction, and no System Five monitoring of that interaction” (Beer, 1979, p. 181). In this case, the whole metasytem collapses into System Three. “The operation of the first three principles must be cyclically maintained through time, and without hiatus or lags” (Beer, 1979, p. 258). This is instantiated with the concept of an Operation Room where “System Three and System Four would exhibit themselves to each other, in a continuous mode, and absorb each other’s variety” (Beer, 1979, p. 258). System Five will monitor the balancing operation between Systems Three and System Four. Systems “Three-Two-One plus Three-Four-Five is a viable system - where the second group is metasytemic to the first” (Beer, 1979, p. 259). “What is beyond System Five is

the next level of recursion, of which this fivefold viable system is an operational element” (Beer, 1979, p. 259). The ‘boss’ within System Five supplies closure. Beer has identified the necessary interactive elements of the viable systems as he states below (Beer, 1979, p. 261):

“Our cybernetic enquires ... have elicited Six interactive elements in the vertical plane, all of which appear to be necessary to a viable system, all of which can be identified with logical precision, all of which can be measured in terms of variety exchanges under the three principles of organizations”

All are present in every viable system; normally five of them are not formally recognized or studied as vertical components of the system and should be to determine requisite variety (Beer, 1979).

A division is run by its directorate, shown on the diagram as a box square on the vertical command axis (Beer, 1981). A division is essentially autonomous. “That means it ‘does what it likes’ within just one limitation: it continues to belong to the organism” (Beer, 1981, p. 158-159). Practical managerial constraints include the following (Beer, 1981, pp. 159-161):

1. Operate within the intention of the whole organism.
2. Communicate down the vertical command chain.
3. Accountability...by ascending lines in that axis.
4. Operate within the Coordinating framework of System Two.
5. Submit to the Automatic Control of System Three itself.
6. Sometimes the needs of one division must be sacrificed...to the needs of other divisions.

The first three managerial constraints are the variety-interconnections in the vertical plane of the environmental, the operational, and the managerial domains (Beer, 1981). The fourth managerial constraint are the channels of the metasystemic intervention, the anti-oscillation channels that innervate System Two, and the operational monitoring channels of System Three (Beer, 1981). The last three are “there to contain the residual variety not absorbed by the first three, given the *purposes* of the enterprise as a corporate entity” (Beer, 1981, p. 260). Beer suggests that the first three variety absorbers just happen (but must be recognized) and the second three must be recognized and then designed (Beer, 1979, p. 261). The First Axiom of Management states (Beer, 1970, p. 261):

“The sum of horizontal variety disposed by  $n$  operational elements = the sum of vertical variety disposed on the six vertical components of cooperate cohesion”.

“It is a question of creating a language that will discuss a viable system and then using this language to describe how enterprises actually *are* run” (Beer, 1979, p. 225). “To use this work, in short, it is VITAL to know at all times at exactly which level of recursion one is operating. And since many managers operate at different level of recursion, in different roles, confusion often occurs” (Beer, 1979, p. 226). The environment of the viable system is the environment that has to be considered as an operational element of the metasystem (a level of recursion higher) (Beer, 1979). The use of the VSM necessitates the understanding of the system boundaries chosen and their relationship to the boundaries established at the next higher level of recursion.



## CHANNELS IN THE VSM

Communication paths exist within the elements of the VSM (Beer, 1979). “From the standard organizational chart, one would think communication would be one vertical channel up and down the chart and would be called the ”command channel where authority is delegate downwards and in return the acceptance of responsibility and accountability would flow upwards” (Beer, 1979, p. 216). Beer had identified six primary channels that operate along the vertical plane and handle the channel variety associated with the viable system (Beer, 1979). The first three primary communication channels Beer describes are the “variety-interconnections in the vertical plane of the ENVIRONMENTAL, the OPERATIONAL, and the MANAGERIAL domains” (Beer, 1979, p.216). Beer describes these as (Beer, 1979, p. 216):

“Proliferating variety is absorbed by the interactions of elemental units among themselves. Environments can never be disconnected. Operations are invariably connected, although their interactions may be strong or weak – and therefore may absorb much or little of each other’s variety. In the vertical managerial domain, managers necessarily curtail the variety of their colleagues as the stamp of their own personalities on the behavior of the elemental units becomes manifest, and as each learns to tolerate the resulting performance profile of adjacent units is a willing spirit of teamwork”.

The second three primary communication channels Beer describes are the channels of “METASYSTEMIC INTERVENTION (normally confused with inherited ‘chain of command’), and the ANTI-OSCILLATION CHANNELS that innervate System Two, and the OPERATIONAL MONITORING CHANNELS of System Three” (Beer, 1979, p. 216). Beer describes these as (Beer, 1979, p. 216):

“These are all management activities that result from embedding of System One in a metasytem. Unlike the first three variety absorbers, which are given in the nature of the enterprise for that particular System One, these three variety absorbers are subsystems of the metasytem itself. They are there to contain the residual not absorbed by the first three, given the purposes of the enterprise as a corporate entity. The first three variety absorbers just happen, but must be recognized. The second three must be recognized, and then designed”.

The communication channels in the VSM are the elements that connect both the diverse functions specified in the VSM and the organization with its environment(s) (Ríos, 2012). The channels provide the equilibrium, balance or homeostasis of the internal environment of the system in view. The six primary channels and one additional channel of the VSM can be characterized as follows (Ríos, 2012, p. 61):

1. Channel One – C1 – Channel connecting and absorbing variety between the environments of each elementary operational unit.
2. Channel Two – C2 – Channel connecting the various elemental operations (operational units making up System One).
3. Channel Three – C3 – Corporate intervention channel (System Three-System One).
4. Channel Four – C4 – Resources bargaining channel (System Three – System One).
5. Channel Five – C5 – Anti-oscillatory channels (Co-ordination) (System Two).
6. Channel Six – C6 – Monitor channel (Auditor).

7. Algedonic Channel – Transmits alert signal concerning any event or circumstance that could jeopardize the organization. Travels straight to the top through existing links.

The primary VSM communication channels can be seen in Figure 11 below:

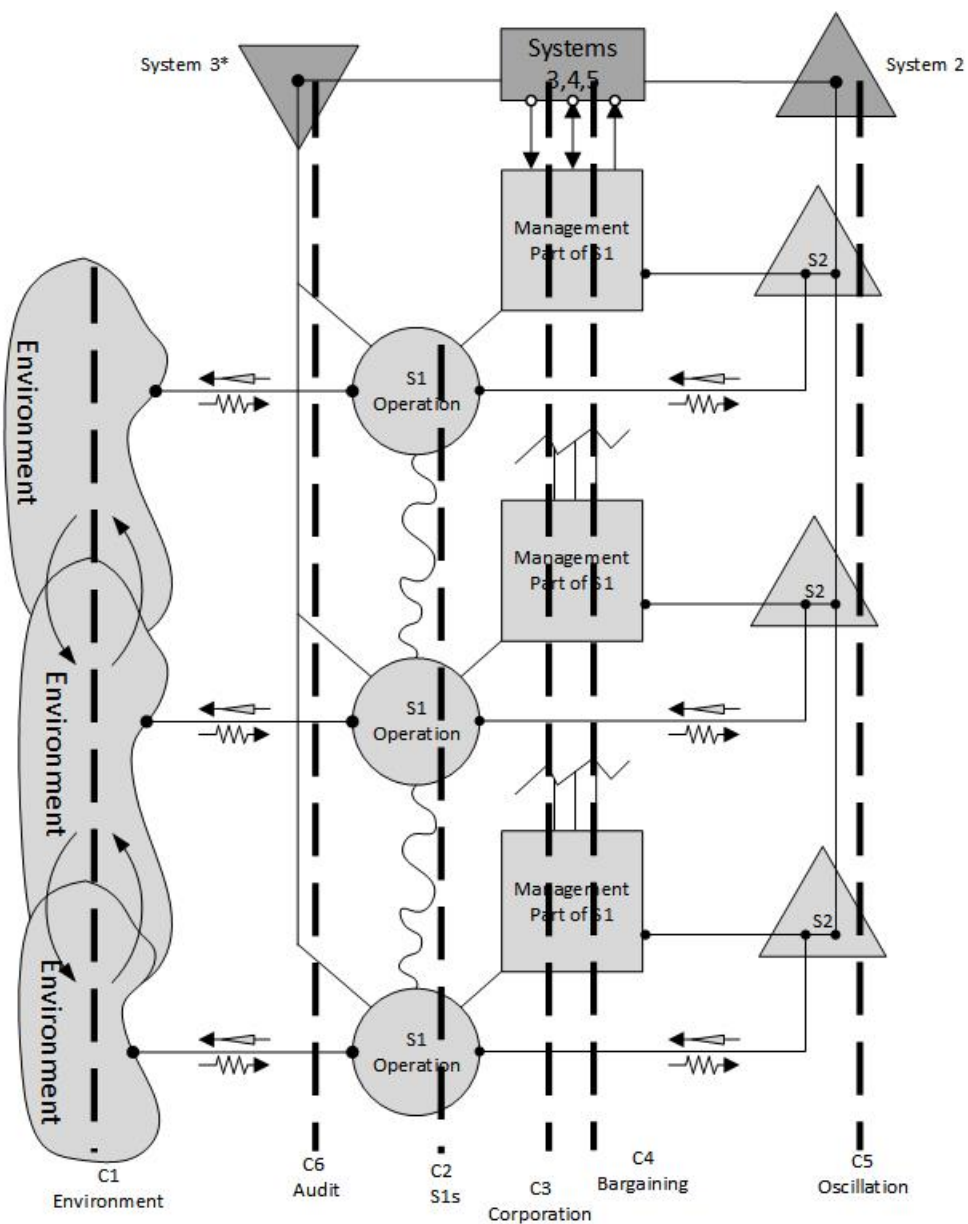

**Figure 11: VSM Six Primary Channels {Adapted from Ríos, 2012, p. 61}**

The communication channels include those between the environment and the Systems called C1.

The C2 channels are between the S1's. The C3 cooperation channels are between the

management portion of the S1's up and including the management portion of S3. The C4 channels provide the bargaining that goes on between the S1's and managed by the S3. The C5 channel monitors and controls oscillation between the S2's. The C6 channel that provides the auditing function of the S1's using unfiltered data and managed as a S3\* (Star) function. The Algedonic channel provides the emergency channel directly to the top without filtering from the lower systems.

The Systems and Channels of the VSM were described above in the previous paragraphs. These systems and channels are the elements of the model that are used in the VSM lenses into the PMBOK PMS for the framework analysis. The next section describes the need for this knowledge for the adaption of the VSM model.

## **ADAPTING THE VSM MODEL**

The Five Systems and Six Primary Communication Channels (and the Algedonic channel) of the VSM must be understood to build the required framework of analysis of system structure. The systems are numerically labeled, but the numbering does not imply hierarchical power or relationships, but rather an order for model development (Beer, 1979). The VSM can represent a model framework for an analysis of a project. This research explored the relationships between the VSM's different Systems and Channels as they relate to the analysis of PMS. The required framework for analysis developed metrics from the VSM analysis of the PMS and was the basis of analysis for this research effort. The basic axioms and theorems that form the foundations of the VSM were presented as part of this research effort as they link to system theory. The mechanisms of the interactions and communications within a project were

researched as to the impact on project management structure. Case study research reinforced the validity of this analysis. Limited efforts to apply the VSM to project management have occurred to include Britton and Parker's (1993) work on an explication of the VSM for PM; Karataz, Keating, and Henrie's (2011) work on designing PMS using the VSM; and Keating and Varela's (2002) work on PMS.

## **SUMMARY**

This chapter discussed how the cybernetic foundation works of Beer, Clemson, and Weiner have been used as the theoretical foundations for the VSM. The earlier cybernetics works developed its own meta-language for describing organizations at every level. Beer devoted considerable time and effort in the development of his VSM for organizational analysis. The VSM uses the cybernetic language to model five prime systems identifiers of an organization that form the basis of the VSM. These system levels were identified and shown how they could be used to identify organizational structures. The interaction of the 'systems' between each other was defined within the organizational context of project structure.

## **RESEARCH METHODOLOGY**

### **INTRODUCTION**

The purpose of this chapter is to define the methodological foundation for the research design. The chapter begins with a discussion on the qualitative - quantitative historical distinction. The remainder of the chapter discusses case study research as an appropriate research approach in response to the purpose and questions for this research effort. This chapter also discusses how case study research should be approached to ensure verifiability and validity of the research. The importance of data collection and the researcher as observer are also discussed. Research based application of the case study approach to the field of project management is examined as an expansion of the theoretical body of knowledge. It is envisioned this methodology provided foundations for an emerging framework for systems based analysis of project structures using the VSM. The chapter concludes with a summary of case study research.

### **QUALITATIVE - QUANTITATIVE HISTORICAL DISTINCTION**

When discussing qualitative research, the discussion of qualitative verses quantitative research method inevitably surfaces. This debate has greatly diminished with the result being that “a variety of approaches are needed and credible, that mixed methods can be especially valuable, and that the challenge is to appropriately match methods to questions rather than adhering to some narrow methodological orthodox” (Patton, 2002, p. xxii). Stake defines three major differences between qualitative and quantitative approaches to research as the following (Stake, 1995, p. 37):

1. The distinction between explanation and understanding as the purpose of inquiry.

2. The distinction between a personal and impersonal role for the researcher.
3. A distinction between knowledge discovered and knowledge constructed.

Stake further explains that the quantitative researcher seeks an ‘explanation and control’ while the qualitative researcher seeks an understanding of the complex interrelationships among all that exists (Stake, 1995, p. 37). With quantitative research, the “research question seeks out a relationship between a small number of variables” (Stake, 1995, p. 37). Conversely with qualitative research, the “research questions typically orient to cases or phenomena, seeking patterns of unanticipated as well as expected relationships” (Stake, 1995, p. 41). Qualitative research “constructs interpretive narratives from their data and try to capture the complexity of the phenomenon under study” (Leedy and Ormrod, 2010, p. 97). For qualitative research, the focus on the interrelationships of the issues illustrates the importance that case study research can have on explaining the context of the subject of the research. Qualitative research develops out of the three kinds of data collection (Patton, 2002, p. 4):

1. In-depth open ended interviews (discussions).
2. Direct observation.
3. Written documents.

This data typically comes from fieldwork and the quality associated with this work and data collection is a direct reflection of the capabilities of the researcher (Patton, 2002). Data discovery can come from direct observation, lived experience, or searching through the vast material of libraries (Denzin and Lincoln, 2005; Glaser and Strauss, 2010). The reliance on particular data type is the choice of the observer and how the strategy of inquiry is developed. Gathering as much relevant information as possible on the topic of study is essential to theory development



(Glaser and Strauss, 2010). “Qualitative validity means that the researcher checks for the accuracy of the findings by employing certain procedures while qualitative reliability indicates that the researcher’s approach remains consistent irrespective of different researchers and different projects (Gibbs, 2007)”(Creswell, 2009, p. 190). “Validity is one of the strengths of qualitative research and is based on determining whether the findings are accurate from the standpoint of the researcher, the participant, or the readers of an account (Creswell and Miller, 2000)” (Creswell, 2009, p. 191). It is the credibility in validity that allows case study research to take on a role as a rigorous methodology for researchers. Patton (2002, p. 62) describes the advantages of using “qualitative portrayals of holistic settings and impacts are that greater attention can be given to nuance, setting, interdependencies, complexities, idiosyncrasies, and context”. “Qualitative inquiry elevates context as critical to understanding” (Patton, 2002, p. 63).

Quantitative and qualitative research are both recognized forms of valid and rigorous approaches to conduct research. Quantitative research looks at the research purpose as being the explanation of phenomena, with an impersonal role of the researcher, and knowledge discovered from the system in focus (Stake, 1995). In contrast, Qualitative research looks at the research purpose as being an understanding of the phenomena, with a personal role of the researcher, and knowledge constructed from data of the system in focus (Stake, 1995). Case study research uses qualitative data and achieves validity through the rigorous methodology application to produce creditable research. Qualitative research has advantages for developing critical understanding of complex contextual organization discovery (Patton, 2002).

## CASE STUDY RESEARCH AS A QUALITATIVE METHOD

Case study research is used to enlighten and gain knowledge into complex social phenomena, which can be: a person, group of people, an organization, a social situation, or political phenomena (Yin, 2009). Yin states “the case study method allows investigators to retain the holistic and meaningful characteristics of real-life events - such as individual life cycles, small group behavior, organizational and managerial process, neighborhood change, school performance, international relations and the maturation of industries” (2009, p. 4). Case study research is a way of researching an empirical topic by following a set of pre-specified procedures while reviewing the logic of design, the data collection methodology, and specification of a unique data analysis approach (Yin, 2009, pp. 18-21). Yin (2009) describes a linear, but iterative process for doing case study research in his book, *Case Study Research: Design and Methods*, 4<sup>th</sup> edition. The guideline goes through the following processes: plan, design, prepare, collect, analyze, and share along with iterations (Yin, 2009).

This research used the exploratory case study as a methodology to study how the Viable System Model (VSM) can be adapted for analysis of project management structure. The exploratory method was chosen as this is a “contemporary set of events” over which the researcher has little or no control concerning the organizational structure (Yin, 2009, p. 12). The case study approach was used with the two selected case studies (projects) based on the technical definition of case study research by Yin (Yin, 2009, p. 18). This case study research allowed the analytic generalization of the research proposition that the Viable System Model (VSM) can be adapted for analysis of project management structures. The criteria for judging the quality of this exploratory research design was based on Yin’s four tests (Yin, 2009, p. 40): construct validity,

internal validity, external validity, and reliability. The four tests summarized by Kidder & Judd (1986, pp. 26-29) are given below (Yin, 2009, p. 40):

1. Construct validity: identifying correct operational measures for the concepts being studied.
2. Internal validity (for explanatory or causal studies only and not to descriptive or exploratory studies): seeking to establish a causal relationship, whereby certain conditions are believed to lead to other conditions, as distinguished from spurious relationships.
3. External validity: defining the domain to which a study's findings can be generalized.
4. Reliability: demonstrating that the operations of a study – such as the data collection procedures – can be repeated, with the same results.

A rigorous and methodological consistent case study research approach was first required in the initial planning and research design following Yin (2009). The researcher's initial planning may include the identification of the research question and the choice of case study methods. In this case the exploratory method was selected as most appropriate for this research. The research design included at least the following components as shown below in Table 4:

Design Characteristics	Description
Research Question (s)	How can the Viable System Model (VSM) be adapted for analysis of project management structure? What results from exploration of the Viable System Model framework application to active project management structures?
Question's propositions	Using case study research to explore the use of the VSM to study project management structures.
Unit of analysis	Single Project. (government, small 3 < project team < 12 members)
Logic linking the data to propositions	The project level analysis of using the VSM to identify PMS.
Criteria for interpreting study's findings	Identify and address rival theories.

**Table 4: Research Design Components {Adapted from (Yin, 2009, pp. 35-36)}**

Important elements that a researcher must determine are the research question, propositions, unit of analysis, and the logic linking these elements together (Yin, 2009). The quality of any given design can be judged according to logical tests which for case study research would include construct validity, internal validity, external validity, and reliability (Yin, 2009, p. 40). The proposed case study framework followed the design principles gathered by Yin (2009) offering a well-established documented research design that has withstood scrutiny and has been well accepted by the scholarly community.

Empirical research requires there to be a research design (Yin, 2009). Yin states simply that “the design is the logical sequence that connects the empirical data to a study’s initial research question and, ultimately, to the conclusions” (Yin, 2009, p. 27). It can be said “a research design is *a logical plan for getting from here to there*, where *here* may be defined as the initial set of questions to be answered, and *there* is some set of conclusions (answers) about these questions (Yin, 2009). Between (the) “here” and “there” may be found a number of major steps,

including the collection and analysis of relevant data” (Yin, 2009, p. 26). Yin cited another definition that describes the research plan as one that “guides the investigator in the process of collecting, analyzing, and interpreting observation” (Yin, 2009). The research plan is a logical model of proof that allows the researcher to draw inferences concerning causal relations among the variables under investigation (Yin, 2009). In depth study of organizations has to be analyzed to determine the phenomena or issue of interest (Yin, 2009).

Case study research is used to enlighten and gain knowledge into complex social phenomena (Yin, 2009). Case study research is a way of researching an empirical topic by following a set of pre-specified procedures while reviewing the logic of design, the data collection methodology, and specifies a unique data analysis approach (Yin, 2009). This research used the exploratory case study as a methodology to study how the Viable System Model (VSM) can be used for the analysis of project management structure. This case study research allowed the analytic generalization of the research proposition that the Viable System Model (VSM) can be adapted for analysis of project management structures following the case study methodology provided by Yin (2009). The Case Study research methodology used in this research is described in the following sections.

## **CASE STUDY RESEARCH**

Case Study Research (CSR) has developed over the years as a proven method for social science inquiry but has captured the least attention and guidance in contrast to other methods. (Yin, 2003). Case study research is often used when the phenomenon to be studied is not clearly distinguishable from the overall context (Yin, 2003). The present study used case study research

to guide deployment of the VSM framework as the rigorous research tool for the analysis of a project management system within select organizations.

The problems of establishing the construct validity and reliability of case study research can be made by using the six sources of evidence and following the three principles of data collection suggested by Yin (2009, p. 114). The three Principles of Data Collection are:

1. Use Multiple Sources of Evidence.
2. Create a Case Study Database.
3. Maintain a Chain of Evidence.

The first principle, using multiple sources of evidence, is an established characteristic of case study research where multiple sources of evidence are used to triangulate or converge on the phenomena of interest (Yin, 2009). The idea of triangulation of data sources allows the sources of data to converge on the facts of the case as can be seen in Figure 12 below:

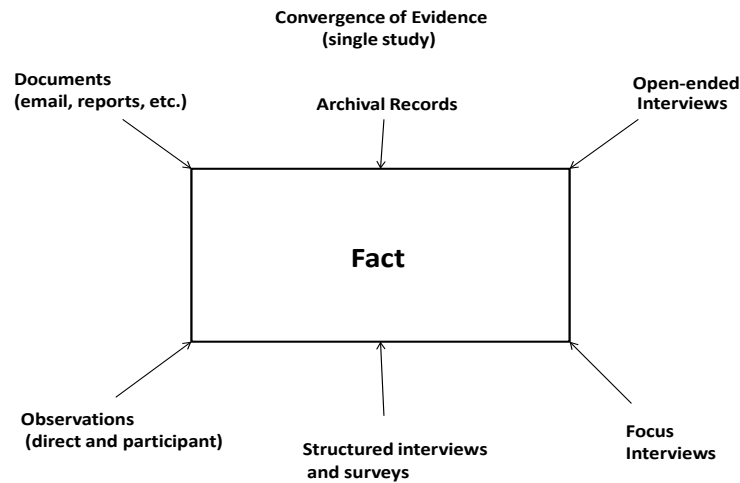

**Figure 12: Convergence of Evidence: Single Case Study {Adapted from (Yin, 2009, p. 117)}**

The second principle of data collection involves the creation of a case study database to organize and document the data collected for the case study (Yin, 2009). The case study database is different from the report of the researcher and should not be confused with the reporting of results (Yin, 2009). Yin (2009) points out four significant problem areas for developing the case study database in Table 5 below:

Database elements	Sources	Problem area
Notes	Interviews	Stored so that they are retrievable
	Observations	Completeness
	Document analysis	Organized according to major subject
		Categorized
Documents	Bibliography of documents	Large amount of physical storage or memory
		Varying importance
		Readily retrievable
		Interview notes cite the documents
Tabular materials	Collected from the site being studied	Organization
	Created by the research team	Stored and Retrievable
	Survey and quantitative data	
Narratives	Case study researcher narratives	Linking pertinent issues to specific evidence through adequate citations

**Table 5: Data Element Sources and Problem Areas to Consider (Yin, 2009)**

The third principle of maintaining a chain of evidence is to allow the reader to follow the path of evidence from the initial research question to the presentation of results for this case study research (Yin, 2009). The idea of traceability is said to be from both directions; i.e. from research questions to conclusion or from conclusion to research question (Yin, 2009). The need to preserve the sources of evidence as they are found is characteristic of the methods used to gather this information (Yin, 2009). A way of maintaining a chain of evidence can be accomplished by observing the following steps as suggested by Yin (2009, p. 123) below:

1. The report should have sufficient citation to the relevant portions of the case study database.
2. The database should reveal the actual evidence and circumstances under which the evidence was collected.



3. These circumstances should be consistent with the specific procedures and question contained in the case study protocol, showing the data collection procedure was accomplished by the stipulated protocol.
4. Reading the protocol should show the reader a link between the content of the protocol and the initial research question.

Visually, this can be seen in Figure 13 below:

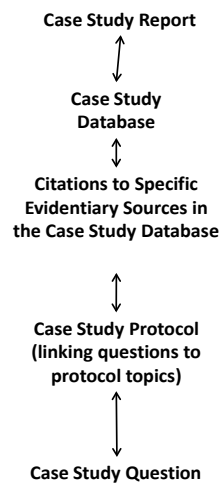

**Figure 13: Maintaining a Chain of Evidence {Adapted from (Yin, 2009, p. 123)}**

The Data Analysis and Interpretation is focused on the process of data analysis and involves the “making sense out of the text and image data” (Creswell, 2009, p. 183). During the analysis

phase the activities described below are examples of what may be occurring (Creswell, 2009, p. 184):

1. Ongoing process about the data, asking analytic questions, writing memos throughout the study.
2. Data is reported in journals (Case study research involves a detailed description of the setting or individuals, followed by analysis of the data for themes or issues. (Stake, 1995).
3. Often qualitative research uses a general procedure and convey in the proposal, the steps in data analysis. An ideal situation is to blend the general steps with the specific research strategy steps.

An interactive flow can be seen in the Data Analysis in Qualitative Research Figure 14 below:

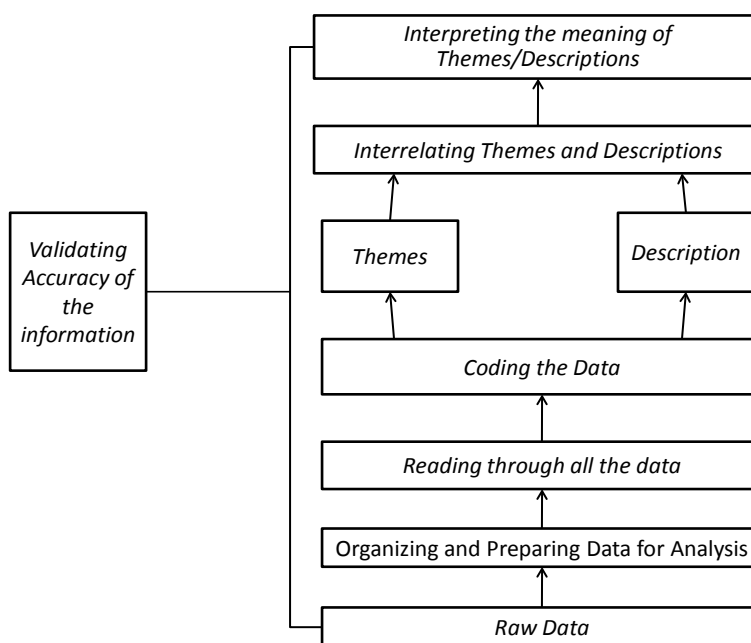

**Figure 14: Data Analysis in Qualitative Research {Adapted from (Creswell, 2009, p. 185)}**

This section explained how a structured case study research approach could be effectively used for research based on its methodical and rigorous design (Yin, 2009). The three Principles of Data Collection for case study were discussed (Yin, 2009), including: (1) Use of Multiple Sources of Evidence; (2) Creating a Case Study Database; and (3) Maintaining a Chain of Evidence. The development of themes and descriptions were described as stemming from the data collected. The making sense of the data is part of the research design which is discussed in the next section.

## COMPONENTS OF RESEARCH DESIGN

Yin (2009) had identified five components of a research design as a guideline for designing case study research efforts as given below:

1. A study's question.
2. Its proposition, if any.
3. Its unit(s) of analysis.
4. The logic linking the data to the propositions.
5. The criteria for interpreting the findings.

It is important to understand each of the research design guideline components. The next paragraphs helped define each of the individual research design components.

A study's question, the *form* of the question – in terms of “who”, “what”, “where”, “how” and “why” – provides an important clue regarding the most relevant research method to be used” (Yin, 2009, p. 27). Yin then states “the case study method is most likely to be appropriate for the “how” and “why” questions” (Yin, 2009, p. 27). Yin suggests narrowing the literature search down to one or two topics of interest (Yin, 2009). Further Yin suggests dissecting a few key studies in these areas to the study's questions to help the researcher develop some unique research questions (Yin, 2009). Finally, look at similar studies to help narrow the focus area down to the area of interest to the researcher (Yin, 2009, p. 27).

The use of propositions in research design helps point towards the relevant evidence to support the stated proposition (Yin, 2009). “Each proposition directs attention to something that should be examined within the scope of study” (Yin, 2009, p. 28). Generally speaking, research design originally flowed with the “how” and “why” questions (Yin, 2009). This flow should lead

the researcher towards relevant topics and help to define the scope of the research (Yin, 2009). Studies without propositions would instead have the topic as the subject of “exploration” (Yin, 2009). This exploration should have a defined purpose as would the propositions (Yin, 2009, p. 28). Similarly, this research efforts sets out to answer the ‘How’ and ‘Why’ questions.

Defining what the “case” is as the unit(s) of analysis is a necessary and important component of research design (Yin, 2009, p. 29). A “case” may be an individual, a project, an organization, a decision, programs, implementation processes, organization change, etc. (Yin, 2009, p. 29). Defining the case then becomes the task of structuring relevant questions and propositions so as to gain knowledge for the case. Without this structure, the desire to know everything may develop, which is an impossible task (Yin, 2009). “The more the case study contains specific question and proposition, the more it will stay within feasible limits” (Yin, 2009, p. 29). The unit of analysis chosen relates to the original research question, which also relates to the associated questions and propositions, which would then relate to the data collection plan (Yin, 2009). The implication of a balance between these choices is seen as an iterative process to ensure the original research question can be addressed in the case study (Yin, 2009, p. 30). Once the researcher identifies the general case study, the context of the individual case can then be identified. The identification of boundaries associated with the “case” begin to be defined, such as internal/external participants, start/stop time, and other spatial, temporal, or clearly defined boundaries (Yin, 2009, p. 32). “The researcher will need to compare findings with previous research to ensure unit of analysis are similar and clearly comprehensible to the previous case studies” (Yin, 2009, p. 32).

Another component of case study design is the logic linking the data to the propositions by way of pattern matching, explanation building, time-series analysis, logic models, and cross-case synthesis (Yin, 2009, p. 34). Linking case study data to the initial propositions was required for this empirical study. The desire is to get the right amount of data to complete this task, too little would have required a relook at the case and collecting more data (Yin, 2009). Too much data could have been interpreted as a wasted effort on collection, perhaps a sign the researcher's focus was off (Yin, 2009), this was not the case for the present research effort.

Interpreting the case study's finding is an important component of research design (Yin, 2009). The early identification of rival theories and the gathering of data that will help defend the researchers theories will help justify a researcher's position (Yin, 2009). The use of statistical analysis to explain significance in criteria is not as prevalent in case study research as in other methods of research (Yin, 2009). The researcher must identify and explain the results with insight and data to support this opposing position and developed this methodology for interpreting the case study's findings (Yin, 2009).

A unique difference between case study research and other research methods relates to the role of theory in design work (Yin, 2009). Unlike other research methods like ethnography (Lincoln and Guba, 1985; Van Maanen, 1988) and 'grounded theory' (Corbin and Strauss, 2008) in case study research the role of theory development occurs prior to the conduct of any data collection (Yin, 2009, p. 35). "The relevant field contacts depend upon an understanding – or theory – of what is being studied" (Yin, 2009, p. 35). The theory must relate to the topic of study which relates to the questions and propositions (Yin, 2009).

It is essential that theory development be part of the initial design phase (Yin, 2009). This is where the initial theory and rival theory can be introduced. Once stated, the research design phase will begin to describe the theory using the design components mentioned earlier: the study's question, its proposition, its unit(s) of analysis, the logic linking the data to the propositions, and the criteria for interpreting the findings (Yin, 2009, p. 36). This is where the development of the blueprint begins, the plan for research. This blueprint "requires theoretical positions, usefully noted by Sutton and Straw (1995) as "a [hypothetical] story about the acts, events, structure, and thoughts occur" (Yin, 2009, p. 36). From here, the case study has a strong plan of action to move forward. Depending on the level of existing work that may be available on the researcher's topic, case studies may range from explanatory, descriptive, or exploratory in nature (Yin, 2009, p. 36).

Theory development in the research design phase helps the researcher to suggest generalization from the case study to theory when the focus area has been derived from a well thought out research plan (Yin, 2009). The researcher typically uses case study research to make an analytic generalization "in which previously developed theory is used as a template with which to compare empirical results of the case study" (Yin, 2009, p. 38). This is different than statistical generalization where "an inference is made about a population (or universe) on the basis of empirical data collected about a sample from that universe" (Yin, 2009, p. 38). "When two or more cases are shown to support the same theory, replication may be claimed" (Yin, 2009, pp. 38-39). "The empirical results may be considered yet more potent if two or more cases support the same theory but do not support an equally plausible, *rival* theory" (Yin, 2009, p. 39).

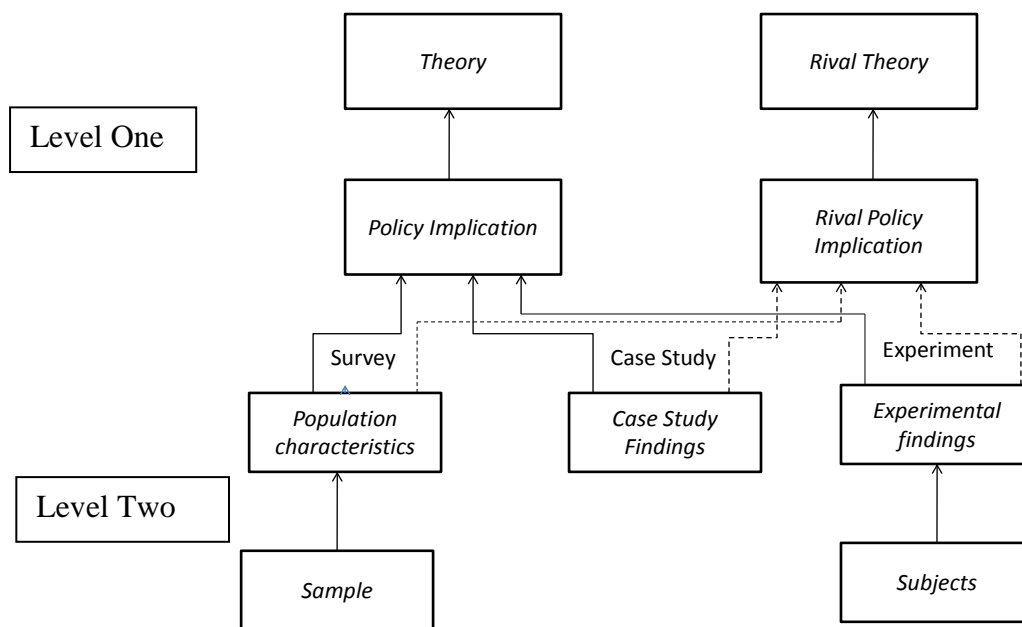

**Figure 15: Making Inferences {Adapted from (Yin, 2009, p. 39)}**

From Figure 15 above, Level Two inferences are the goal of the researcher doing case study research as this is where the analytic generalization is often made (Yin, 2009).

A logical goal at this point is to determine the criteria for judging the quality of the research design constructed by the researcher (Yin 2009). Yin (2009) states the concepts for criteria judgment of the research design center around trustworthiness, credibility, confirmability, and data dependability (U.S. Government Accounting Office, 1990). There are four tests “that have been commonly used to establish the quality of any empirical social research. Because case studies are one form of such research, the four tests also are relevant to case studies” (Yin,



2009, p. 40). The four tests summarized by Kidder and Judd (1986, pp. 26-29) are given below (Yin, 2009, p. 40).

1. Construct validity: identifying correct operational measures for the concepts being studied.
2. Internal validity (for explanatory or causal studies only and not to descriptive or exploratory studies): seeking to establish a causal relationship, whereby certain conditions are believed to lead to other conditions, as distinguished from spurious relationships.
3. External validity: defining the domain to which a study's findings can be generalized.
4. Reliability: demonstrating that the operations of a study – such as the data collection procedures – can be repeated, with the same results.

“A noted criticism of case study research has always been that “subjective judgments” are made when collecting the case study data hampering construct validity” (Yin, 2009, p. 41). “The researcher needs to identify correct operational measures for the case in study to ensure validity in one's research. Yin provides two tests to ensure construct validity” (Yin, 2009, p. 42):

1. Define neighborhood change in terms of specific concepts (and relate them to the original objectives of the study).
2. Identify operational measures that match the concepts (preferably citing published studies that make the same matches).

Yin also notes three tactics used to ensure construct validity (Yin, 2009). “The first is the use of *multiple sources of evidence*, in a manner encouraging convergent lines of inquiry, and this tactic is relevant during data collection.....A second tactic is to establish a *chain of evidence*, also

relevant during data collection... The third tactic is to have the draft cases study report reviewed by key informants” (Yin, 2009, p. 42).

“Internal validity is mainly a concern for exploratory case studies, when an investigator is trying to explain how and why event  $x$  led to event  $y$ ” (Yin, 2009, p. 42). Incorrectly linking the cause of an event or not taking into account other variables that may have caused an event invalidates the evidence. Yin notes that this causal relationship “is inapplicable to descriptive or exploratory studies (whether the studies are case studies, surveys, or experiments), which are not concerned with this kind of causal situation” (Yin, 2009, p. 43). Problems with internal validity can occur when “an investigator will ‘infer’ that a particular event resulted from some earlier occurrence, based on interview and documentary evidence collected as part of the case study” (Yin, 2009, p. 43). Issues related to internal validity can be mitigated by addressing these potential problems and issues early and throughout the case study, hence avoiding these mistakes. As there are no specific tactics for ensuring internal validity, some additional tactics may include “the analytic tactic of *pattern matching*..., *explanations building*, *addressing rival explanation*, and *using logic models*” (Yin, 2009, p. 43).

‘Judging’ the quality of research design “deals with the problem of knowing whether a study’s findings are generalizable beyond the immediate case study”, or external validity (Yin, 2009, p. 43). Yin (2009) stresses that the researcher should recall that generalization associated case study research is different from generalization associated with statistical definitions where a sample is representative of the universe. With case study research, the generalization is of an analytical nature and not automatic (Yin, 2009). The researcher is “striving to generalize a particular set of results to some broader theory” (Yin, 2009, p. 43). “A theory must be tested by

replicating the findings in a second or even a third neighborhood, where the theory has specified that the same results should occur. Once such direct replications have been made, the results might be accepted as providing strong support for the theory, even though further replications had not been performed. This replication logic is the same that underlies the use of experiment (and allows scientist to cumulate knowledge across experiments)” (Yin, 2009, p. 44).

The quality of research designs can also be judged on the reliability of the design (Yin, 2009). The ability of a different researcher to emulate, following the original researcher’s design and methods, and do the same case study again is a step in defining case study design reliability (Yin, 2009, p. 45). “The emphasis is on doing the *same* case over and over again, not on the “replicating” the results of one case by doing another case study. The goal is to minimize the errors and biases in a study” (Yin, 2009, p. 45). The researcher needs to document the procedures so that another researcher can conduct the same case study (Yin, 2009). It has been suggested that previous “case study research procedures have been poorly documented, making external reviewers suspicious of the reliability of the case study method” (Yin, 2009, p. 45). Several tactics used to mitigate the appearance of poor documentation include to “use a *case study protocol* to deal with the documentation problem in detail.....and the development of a *case study database*” (Yin, 2009, p. 45). In summary, “A good guideline for doing case studies is therefore to conduct the research so that an auditor could in principle repeat the procedures and arrive at the same results” (Yin, 2009, p. 45).

This section explored the identified five components of a research design as a guideline for case study based research efforts, including: (1) a study’s question; (2) its proposition; (3) its unit(s) of analysis; (4) the logic linking the data to the propositions; and (5) the criteria for

interpreting the findings. Designing the case study also requires the interpretation of the case study's finding as it is an important component of research design (Yin, 2009). It is essential that theory development be part of the initial design phase (Yin, 2009). Theory development in the research design phase helps the researcher to make generalization from the case study to theory when the focus area has been derived from a well thought out research plan (Yin, 2009). The four tests commonly used to establish the quality of any empirical social research were discussed (Yin, 2009), including: (1) construct validity; (2) internal validity; (3) external validity; and (4) reliability. The importance of replication of a method of achieving validity in case study research was also described in this section. Case study design is developed in the following section.

## **CASE STUDY DESIGNS**

Yin identifies four basic types of design for case studies. The four basic types of designs for case studies are (Yin, 2009, pp. 46-47):

1. Single case (holistic) designs.
2. Single case (embedded) designs.
3. Multiple-case (holistic) designs.
4. Multiple-case (embedded) designs.

The major distinction between the two basic forms of case studies is that one is single case and the other is multi-case designs (Yin, 2009). There are several rationalizations for a single case study, they may include the following (Yin, 2009, pp. 47-49):

1. The case represents the *critical case* in testing a well-formulated theory.
2. The case represents an *extreme* or a *unique* case.

3. The case is the *representative* or *typical* case.
4. The case is the *revelatory* case.
5. The case is the *longitudinal* case: studying the same single case at two or more different points in time.

When the case represents the *critical* case, “the case is testing a well-formulated theory” where the case has propositions and circumstances that are clearly defined and a significant contribution to knowledge and theory building exists (Yin, 2009, p. 47). For the *extreme* or *unique* cases the rationale would be that the documentation and analysis of any such case goes beyond what exists in the present (Yin, 2009). For the *representative* or *typical* case the rationale is to “capture the circumstances and conditions of an everyday or common place situation” (Yin, 2009, p. 48). “For the *revelatory* case the rationale is the researcher has an opportunity to observe and analyze a phenomenon previously inaccessible to social science inquiry” (Yin, 2009, p. 48). For the *longitudinal* case the rationale “the theory of interest would likely specify how certain conditions change over time, and the desired time intervals would presumably reflect the anticipated stages at which the changes should reveal themselves” (Yin, 2009, p. 49). A “potential vulnerability of the single-case design is that a case may later turn out not to be the case it was thought to be at the outset” (Yin, 2009, pp. 49-50). Upfront planning to address major concerns will help mitigate this risk.

A full understanding of the holistic versus the embedded case studies is needed to understand the case; each has its advantages and disadvantages (Yin, 2009). An embedded case study design occurs when a single case attention focuses on a specific subunit(s) of the case (Yin, 2009, p. 50). An example may be if the case study was about a government organization

and then conclusions about employee demographics are presented. “A major one [pitfall] occurs when the case study focuses only on the subunit level and fails to return to the larger unit of analysis” (Yin, 2009, p. 52). Yin provides an example of this below:

An evaluation of a program consisting of multiple projects may include project characteristics as a subunit of analysis. The project-level data may even be highly quantitative if there are many projects. However, the original evaluation becomes a project study (i.e., a multiple-case study of different projects) if no investigating is done at the level of the original case – that is, the program. (Yin, 2009, p. 52)

A holistic case study design examines the “global nature of an organization or of a program” (Yin, 2009, p. 50). “The holistic design is advantageous when no logical subunits can be identified or when the relevant theory underlying the case study is itself of a holistic nature. Potential problems arise, however, when a global approach allows the investigator to avoid examining any specific phenomenon in operational detail. Thus a typical problem with the holistic design is that the entire case study may be conducted at an unduly abstract level, lacking sufficiently clear measures of data” (Yin, 2009, p. 50). Another problem with the holistic design is that “the entire nature of the case study may shift, unbeknownst to the researcher, during the course of the study” (Yin, 2009, p. 52).

A multiple-case study is one where more than one case study is performed during the study. Multiple case studies have distinct advantages in contrast to single case studies. “The evidence from multiple cases is often considered more compelling, and the overall study is therefore regarded as being more robust (Herriott and Firestone, 1983)” (Yin, 2009, p. 53). “By definition, the unusual or rare case, the critical case, and the revelatory case all are likely only

single cases” (Yin, 2009, p. 53). Multiple case studies are designed to show replication of issues not for the purpose of sampling the data; the methodology for these types of case study design is not the same. For multiple case studies “each case must be carefully selected so that it either (a) predicts similar results (a *literal replication*) or (b) predicts contrasting results but for anticipatable reasons (a *theoretical replication*)” (Yin, 2009, p. 54).

“An important step in all of these replication procedures is the development of a rich, theoretical framework. The framework needs to state the conditions under which a particular phenomenon is likely to be found (a literal replication) as well as the conditions when it is not likely to be found (a theoretical replication). The theoretical framework later becomes the vehicle for generalizing to new cases, again similar to the role played in cross-experiment designs. Furthermore, just as with experimental science, if some of the empirical cases do not work as predicted, modification must be made to the theory.

Remember, too, that theories can be practical and not just academic” (Yin, 2009, p. 54).

The replication approach to multiple-case studies is shown in Figure 16 below:

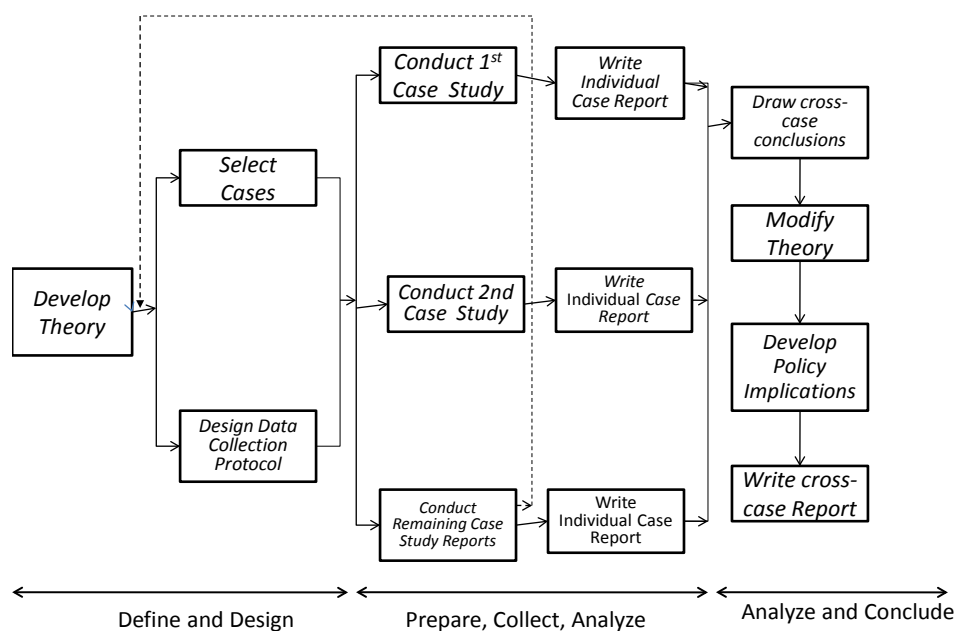

**Figure 16: Case Study Method {Adapted from (Yin, 2009, p. 57)}**

The case study method shown above is best described by Yin below (2009, p .56):

The figure indicates that the initial step in designing the study must consist of theory development, and then shows that case selection and the definition of specific measures are important steps in the design and data collection process. Each individual case study consists of a “whole” study, in which convergent evidence is sought regarding the facts and conclusions for the case; each case’s conclusions are then considered to be information needing replication by other individual cases. Both the individual cases and the multiple-case results can and should be the focus of a summary report. For each individual case, the report should indicate how and why a particular proposition was demonstrated (or not demonstrated). Across cases, the report should indicate the extent of



replication logic and why certain cases were predicted to have certain results, whereas other cases, if any, were predicted to have contrasting results.

Particular attention to the loop in the Figure 16 should be made by the researcher as this is the feedback loop that occurs after each case, signifying knowledge gained (Yin, 2009). This new insight may require a re-design (Yin, 2009). The need for replication is associated with the strength of the rival propositions (Yin, 2009, p. 58). The rationale for multiple case studies derives from the researcher's understanding of literal and theoretical replications (Yin, 2009). With the multiple case inquiry, prior knowledge allows the researcher to focus on the "how" and "why" of a case outcome (Yin, 2009, p. 59).

This section described the differences between single and multiple case study designs. An understanding of whether the case study is embedded or holistic occurs in the early design of the case study. The use of replication for multiple case studies requires attention to be given to the framework of analysis. This framework allows for the replication of the case study providing a higher level of validity sought by the researcher. The next section examines the preparation techniques for collection of case study data.

## **PREPARING TO COLLECT CASE STUDY EVIDENCE**

After the design of a case study and before data can be collected, the researcher needs to prepare to collect the evidence. Yin (2009) describes the preparation to include the following: hone skills as a case study investigator, be prepared for one's specific case study, develop the case study protocol, conduct a pilot case study, and ensure the approval for human subject's protection (Yin, 2009, p. 66).

## CASE STUDY RESEARCHER SKILLS

Commonly desired skills required for a good case study researcher are given below (Yin, 2009, p. 69):

1. A good case study investigator should be able to *ask good questions* – and interpret the answers.
2. An investigator should be a good “*listener*” and not trapped by her or his own ideologies or preconceptions.
3. An investigator should be *adaptive* and *flexible*, so that newly encountered situations can be seen as opportunities, not threats.
4. An investigator must have a *firm grasp of the issues being studied*, even if in an exploratory mode. Such a grasp reduces the relevant events and information to be sought to manageable proportions.
5. A person should be *unbiased by preconceived notions*, including those derived from theory. Thus, a person should be sensitive and responsive to contradictory evidence.

The researcher needs to ask good questions to establish a well-rounded body of evidence related to the case study (Yin, 2009). The wording of the questions in an discussion can make a significant difference in the way the interviewee answers the questions thereby affecting the quality of the research (Patton, 2002). Yin emphasized what this encompasses, from Becker below (Yin, 2009, p. 69):

Pondering the possibilities gained from deep familiarity with some aspect of the world, systemizing those ideas in relation to kinds of information one might gather,

checking the ideas in the light of that information, dealing with the inevitable discrepancies between what was expected and what was found by rethinking the possibilities of getting more data, and so on.

Asking good questions will help the researcher better understand the circumstances unfolding, as the answers are not predictable, but may provide insight into further data gathering (Yin, 2009). Following the protocol may become routine in nature and the Yin reminds the researcher to maintain diligently and awareness of what is being collected and the associated environment (Yin, 2009, p. 70). The questions may lead to a deeper inquiry than originally planned that is also a sign of a good investigator as deeper insight into the case study question is the ultimate goal (Yin, 2009).

Being a good listener goes beyond just recording the answers that are given to the questions (Yin, 2009). Insight into the underlying conditions and environment can be attained by an attentive researcher. A “good listener hears the exact words used by the interviewee (sometimes, the terminology reflects an important orientation), captures the mood and affective components, and understands the context from which the interviewee is perceiving the world” (Yin, 2009, p. 70). Listening comes in the form of seeing what is in documentation. The researcher’s intuitive grasp of an issue may lead to a relevant information source (Yin, 2009). Yin mentions that having a “closed mind” or “poor memory” may hamper the researcher in gathering or retained valuable relevant data (Yin, 2009, p. 70).

A case study researcher typically cannot design a perfect research endeavor (Yin, 2009). A researcher’s ability to be “adaptive and flexible” requires the researcher to make changes to the case study when the need arises. Minor changes may lead the researcher to a new lead,

whereas a major change may lead the researcher to change the case study design altogether (Yin, 2009, p. 70). When the data or direction changes during the collecting of data, the researcher must reflect this and not insert biases or omissions (Yin, 2009). This is where the researcher may have to stop and redesign the case study as the original design does not meet case in question. “The need to balance adaptiveness with *rigor* - but not rigidity - cannot be overemphasized” (Yin, 2009, p. 71).

A case study researcher must have a firm grasp of the issues being studied (Yin, 2009). The researcher’s knowledge of the theory behind the case study is needed as analytic judgments are being made throughout the data collection process (Yin, 2009). The researcher is not merely recording the data or just filling in the blocks; the researcher has to interpret that information being gathered and be able to ask the ‘good’ questions when the data appears to be contradicting other evidence (Yin, 2009, pp. 71-72). The researcher, like a detective, is asked to come to the scene after the event has occurred and infer what has actually happened (Yin, 2009). The inferences are corroborated by the evidence gathered at the scene by witness accounts and physical evidence retrieved (Yin, 2009).

“All of the preceding conditions [desired skills required for a good case study researcher] will be negated if an investigator seeks only to use a case study to substantiate a preconceived position” (Yin, 2009, p. 71). The case study researcher must avoid biases. Yin warns the researcher not to use the case study method “to enable you (wrongly) to pursue or (worse yet) advocate particular issues” (Yin, 2009, p 72). A way to avoid bias may be to open the research results to others and document their results, thus reducing the likelihood of biasness by the researcher (Yin, 2009).

This section stated the need to ensure the case study researcher has identified and worked on the skills needed to perform a case study. These skills were identified as : (1) being able to ask good question; (2) be a good listener and don't influence the data with personal ideologies; (3) be adaptable and flexible to new situations; (4) have a firm grasp of the issues being studied; and, (5) be unbiased by preconceived notations. The next section looks at the need for preparation and training for a case study.

### **PREPARATION AND TRAINING FOR A CASE STUDY**

A rigorous case study design will reflect a researcher's preparation and insight into the protection of human subjects. The researcher must ensure that the human subjects are protected from the effects of the case study researcher (Yin, 2009). This typically involves the following below (Yin, 2009, p. 73):

1. Gaining *informed consent* form all persons who may be part of your case study by alerting them to the nature of your case study and formally soliciting their volunteerism in participating in the study.
2. Protecting those who participate in your study from any *harm*, including avoiding the use of any *deception* in your study.
3. Protecting the *privacy and confidentiality* of those who participate so that, as a result of their participation, they will not be unwittingly put in any undesirable position, even such as being on a roster to receive requests to participate in some future study, whether conducted by you or anyone else.

4. Taking special precautions that might be needed to protect especially vulnerable groups (for instance, research involving children).

The researcher's own professional ethics, the site's organizational ethics, or the researcher's educational support facility often provides guidelines for human subject protection (Yin, 2009). Discussing the research and intent with the institutions will reflect the rigor and desire to protect human subjects (Yin, 2009). For this research, the project was the unit of analysis not any subjects. The participants were used to provide feedback on the project and the case study narratives to ensure the perspectives of the project management structure represented a holistic view as seen from the project team members (i.e., a face validation for the researcher constructed case study narratives). The next section examines the development of the case study protocol.

## **THE CASE STUDY PROTOCOL**

The case study protocol defines the procedures and general rules to be followed using the protocol which is different from a survey questionnaire" (Yin, 2009, p. 79). The case study protocol and a survey questionnaire are both directed at a single data point, whether it's a single case or a single respondent (Yin, 2009). A case study protocol is always needed when performing a multiple-case study (Yin, 2009). The protocol is a major way of increasing the *reliability* of case study research and is intended to guide the researcher in carrying out data collection from a single case (Yin, 2009). A case study protocol should have at least the following sections (Yin, 2009, p. 81):

1. Overview of the case study project (project objectives and auspices, case study issues, and relevant readings about the topic being investigated).

2. Field procedures (presentation of credentials, access to the case study “sites”, language pertaining to the protection of human subjects, sources of data, and procedural reminders).
3. Field procedures (the specific questions that the case study must keep in mind in collecting data, “table shells” for specific arrays of data, and the potential sources of information for answering each question ...).
4. Investigator guide for the case study report (outline, format of the data, use and presentation of other documentation, and bibliographical information).

The importance of the protocol helps the researcher to remain focused on the topic and problem areas. This intuitive knowledge of the context and perspective will guide the researcher in the search for supporting information. By writing an overview of the case study, the researcher allows potential knowledge seeker to capitalize on the products of the case study and understand beforehand, the intent and depth of the case study research. There are also potential guidelines for field procedure. A researcher’s “field procedure of the protocol need to emphasize the major tasks in collecting data, including gaining access to key organizations or interviewees” (Yin, 2009, p. 85):

1. Having sufficient resources while in the field – including a personal computer, writing instruments, paper, paper clips, and a pre-established, quiet place to write notes privately.
2. Developing a procedure for calling for assistance and guidance, if needed, from other case study investigators or colleagues.

3. Making a clear schedule of the data collection activities that are expected to be completed within specified periods of time.
4. Providing for unanticipated events, including changes in the availability of interviewees as well as changes in the mood and motivation of the case study investigator.

“The heart of the protocol is a set of substantive questions reflecting your actual line of inquiry” (Yin, 2009, p. 86). Each question should be “posed to you, the investigator, not to an interviewee” and linked to a source of evidence (Yin, 2009, p. 86). Each question of this protocol should reflect a specific type/level potentially categorized by Yin’s five levels of questions below (Yin, 2009, p. 86):

1. Level 1: question asked of specific interviewees.
2. Level 2: questions asked of the individual case (these are the questions in the case study protocol to be answered by the investigator during a single case, even when the single case is part of a larger, multiple-case study).
3. Level 3: questions asked of the pattern of findings across multiple cases.
4. Level 4: questions asked of the entire study – for example, calling the information beyond the case study evidence and including other literature or published data that may have been reviewed.
5. Level 5: normative questions about policy recommendations and conclusions, going beyond the narrow scope of study.

“The questions should cater to the unit of analysis of the case study, which may be at a different level from the unit of data collection of the case study” (Yin, 2009, p. 88). “The common



confusion begins because the data collection sources may be individual people (e.g., interviews with individuals), whereas the unit of analysis of your case study may be a collective (e.g., the organization to which the individual belongs) - a frequent design when the case is about the organization, community, or social group” (Yin, 2009, p. 88). Table 6 below illustrates design verses data collection using different units of analysis:

		Data Collection Source	
		From an individual	From an organization
Design	About an individual	Individual behavior Individual attitudes Individual perceptions	Individual employee records Interview with individual's supervisor; other employees
	About an organization	How organization works Why organization works	Personnel policies Organization outcomes

**Table 6: Design verses Data Collected**

Table 6 above, Design verses Data Collection, helps the researcher to identify exactly what data is desired and ensures parallel information is collected from different sites as during a multiple case study (Yin, 2009, p. 89). The researcher should include an outline in the protocol to guide

in the collection, presentation, and formatting of data (Yin, 2009). This rigor allows other researchers to follow the case (Yin, 2009). The researcher may choose a pilot case to discover unforeseen issues or challenges (Yin, 2009). The protocol helps align the researcher's data collection efforts.

The case study protocol defines the procedures and general rules to be followed using the protocol (Yin, 2009). Yin (2009) reminds the researcher that the protocol is a major way of increasing the *reliability* of case study research and is intended to guide the researcher in carrying out data collection from a single case. The case study protocol should contain at minimum the following sections (Yin, 2009): (1) Overview of the case study project; (2) Field procedures (credentials); (3) Field procedures (questions); and (4) a form of investigator guide for the case study report. The importance of the protocol helps the researcher to remain focused on the topic and problem areas. Design versus Data Collection helps the researcher to identify exactly what data is desired and ensures parallel information is collected from different (Yin, 2009). The case study protocol is used in the collection of case study evidence as described in the next section.

## **COLLECTING CASE STUDY EVIDENCE**

The researcher at this point has planned the case study, created a research design, and has prepared to collect the data. Following the protocol developed, the case study evidence can be categorized as coming from six possible sources: “documents, archival records, direct observation, participant-observation, and physical artifacts” (Yin, 2009, p. 98). The data collection principles can be found in textbooks as was seen with the development of the protocol

of the case study design. Yin reminds the researcher to follow some supporting principles for case study research that have in the past been neglected by the researcher, they include: (a) using multiple sources of evidence; (b) creating a case study database; and (c) maintaining the chain of evidence (Yin, 2009, p. 101). Between the six sources of evidence and the three neglected principles mentioned, the researcher can develop a robust case study. For this reason each concept is elaborated in the following paragraphs.

The six sources of evidence and their strengths and weaknesses are shown in Table 7 below:

Source of Evidence	Strengths	Weaknesses
Documentation	Stable Unconstructive Exact Broad coverage	Retrievability Biased selectivity, if collection is incomplete Reporting bias Access
Archival records	Stable Unconstructive Exact Broad coverage Precise and usually quantitative	Retrievability. Biased selectivity, if collection is incomplete. Reporting bias Access Accessibility due to privacy reasons.
Interviews	Targeted	Bias due to poorly articulated questions
	Insightful	Response bias inaccuracies due to poor recall. Reflectivity
Direct Observations	Reality	Time consuming
	Contextual	Selectivity Reflectivity Cost
Participant Observations	Reality	Time consuming
	Contextual	Selectivity
	Insightful into interpersonal behavior and motives.	Reflectivity Cost Bias due to participant-observer's manipulation of events
Physical Artifacts	Insightful into cultural features.	Selectivity
	Insightful into technical Operations.	Availability

**Table 7: Strengths and Weaknesses {Adapted from (Yin, 2009, p. 102)}**

Documentation, the written word, is a critical part of any case study and takes many forms (Yin, 2009). The importance of organizing the gathered information and the selection of

the information to be gathered is part of what a case study researcher does (Yin, 2009). A

sampling of documents variety is provided by Yin below (2009, p. 103):

1. Letters, memoranda, e-mail correspondence, and other personal documents; such as diaries, calendars, and notes.
2. Agendas, announcements, and minutes of meetings, and other written reports of events.
3. Administrative documents-proposals, progress reports, and other internal records.
4. Formal documents or evaluations of the same “case” that you are studying.
5. News clippings and other articles appearing in the mass media or in community newspapers.

Documentation helps to “corroborate and augment evidence” that the researcher gathers and presents from other sources (Yin, 2009, p. 103). Documents help to ensure the accuracy of the data (i.e., spelling, titles, dates, organizations, etc.) that a researcher may have written in notes or given during an interview (Yin, 2009). The ability to draw inferences from the documentation and help corroborate other sources of information can be useful for the researcher (Yin, 2009). The researcher is cautioned to remember that the purpose of the documentation that has been gathered has not typically been developed for the researcher, but for the author’s purpose (Yin, 2009, p. 105).

Archival records are stored records that can be used by the researcher for case study researcher. Archival records may include the below (Yin, 2009, p. 105):

1. “Public use files” such as the U.S. census and other statistical data made available by federal, state, and local governments.

2. Service records, such as those showing the number of clients served over a given period of time.
3. Organization records, such as budget or personnel records.
4. Maps and charts of the geographical characteristics of a place.
5. Survey data, such as previously collected about a site's employees, residents, or participants.

Most archival records were produced for a specific purpose and audience other than the case study investigation, and these conditions must be fully discussed for interpreting the usefulness and accuracy of the records (Yin, 2009, p. 106). The researcher's job is to evaluate the information retrieved to the relevance of the case study with special attention to inferences being made with full disclosure of the context and original objective for which the information was gathered in the first place (Yin, 2009).

The interview process is another source for the collection of case evidence (Yin, 2009). Yin describes these "guided interviews" as being fluid, but focused (Yin, 2009). The focus requires the researcher to follow the case study protocol developed for the case study and to be unbiased when asking questions (Yin, 2009). Yin (2009) describes three types of interviews for the discussion of case studies: the in-depth interview, the focused interview, and the email interview. The present research used focused discussions with Subject Matter Experts (SME) on the factual details to the subject, professional opinions of the subject, or insights into further investigation as suggested by Yin (2009). The researcher may use focused discussions when the information needed can be extracted by the participant in about an hour. Discussion will follow the data collection protocol developed for the case study (Yin, 2009). One of the best ways to

reduce variations is to prepare a set of questions for the discussions. The predetermined questions still allow the participant to answer in their own way, expressing their thoughts and feelings at will (Patton, 2002). Finally, the researcher may choose to send structured questions over the email to the participant in the form of a formal survey as a method of attaining quantitative data for the case study (Yin, 2009). The researcher is reminded to be aware of the language associated with the environment of the participant to ensure clarity in respondents (Patton, 2002). The researcher will find that by using the discussion process as a source of data collection valuable information and insights can be attained to support the case study under investigation (Yin, 2009).

Direct Observations of a case in its natural settings can range from a formal to an informal event (Yin, 2009). Observations into daily events such as meetings, resources, participants work setting can help the researcher understand the environment being studied (Yin, 2009). Direct observation is useful in providing additional information to the case study researcher. If the case study is about new technology insertion, the researcher is able to better understand the uses of this new technology. To increase the reliability of observed data, two or more observers could be used to observe the event (Yin, 2009).

Participant-Observation can be used when the researcher is not only an observer of the event, but also is part of the event being observed (Yin, 2009). One benefit of the participant-observer is the ability to observe what might be otherwise unavailable for observation (Yin, 2009). This would be the view from 'inside' the case study. With this benefit comes the risk of the following biases (Yin, 2009):

1. Becoming less of an external observer as needed.

2. Participant-observer becomes part of a particular phenomenon under study and becomes more supportive rather than objective.
3. The participant-observer may not have time to document the occurrences due to participatory obligations.
4. The participant observer may be 'in' only a part of the whole phenomenon of study and is unable to "see" the whole event of interest.

Physical Artifacts are another source of evidence which may be "a technological device, a tool or instrument, or work of art, or some other physical evidence" (Yin, 2009, p. 113). In most studies, Yin (2009) points out these artifacts have less potential relevance to the study as the actual use is not directly observed.

This section described the collection of case study evidence. Six sources of evidence that the researcher can use to develop a robust case study were discussed: documentation, archival records, discussions, direct observation, participant observation, and physical artifacts. The three neglected principles that the researcher can use to develop a robust case study were also discussed following Yin (2009): (1) using multiple sources of evidence; (2) creating a case study database; and (3) maintaining the chain of evidence. These six sources of evidence and the three described principles are the basis for collecting case study evidence in a rigorous and methodical way.

## **SUMMARY**

Using case study research as the design methodology for this research supports the need to collect data during the research effort following a rigorous methodology. Following a



rigorous methodology can ensure validity and the ability for the reader to fully understand how the data was collected. This section described the basis of the CSR qualitative research method and the components that make up research design. The section goes on to describe what the sources of data were and some of their strengths and weakness within case study research. The need for validity and reliability in case study research was seen to be achievable by following rigorous practices for data collections such as gathering multiple sources of evidence, creating a case study database, and by maintaining a chain of evidence throughout the case study research. Implementation of these collection methods can help ensure validity and reliability of the data used and are certainly applicable for this case study research effort. The three neglected principles that the researcher can use to develop a robust case study were also discussed (Yin, 2009): (1) using multiple sources of evidence; (2) creating a case study database; and (3) maintaining the chain of evidence. Together the sources of evidence and guiding principles provide a guide for collecting reliable case study evidence.

## **RESEARCH DESIGN**

### **INTRODUCTION**

This research set out to bridge the gap between the Project Management Paradigm within the body of knowledge for project management with that of Project Management Systems. This was achieved by using the Viable System Model with case study research to gain a new perspective of analysis of viability of a project management structure within an organization. Case study research would be used to demonstrate the significance of using the VSM as an analysis tool for project structure and would open the door for future research in this area. The intent of this research was to provide the researcher knowledge of project management structures, using a common language to a level which project management structural analysis could be achieved. The research methodology provided foundations for an emerging framework for systems based analysis of project structures using the adapted VSM. The research design can be broken into two significant areas: (1) The Framework Development Phase; and (2) The Case Study Development Phase. The first phase of the research design looked at the framework development of the VSM used for analysis with PMBOK and its analysis. The second phase of the research design explored the construction and analysis of two case studies using the VSM framework to provide face validation of the findings of the VSM to PMBOK PMS matrix analysis. Figure 17 below provides a visual path of the research design from start to finish:

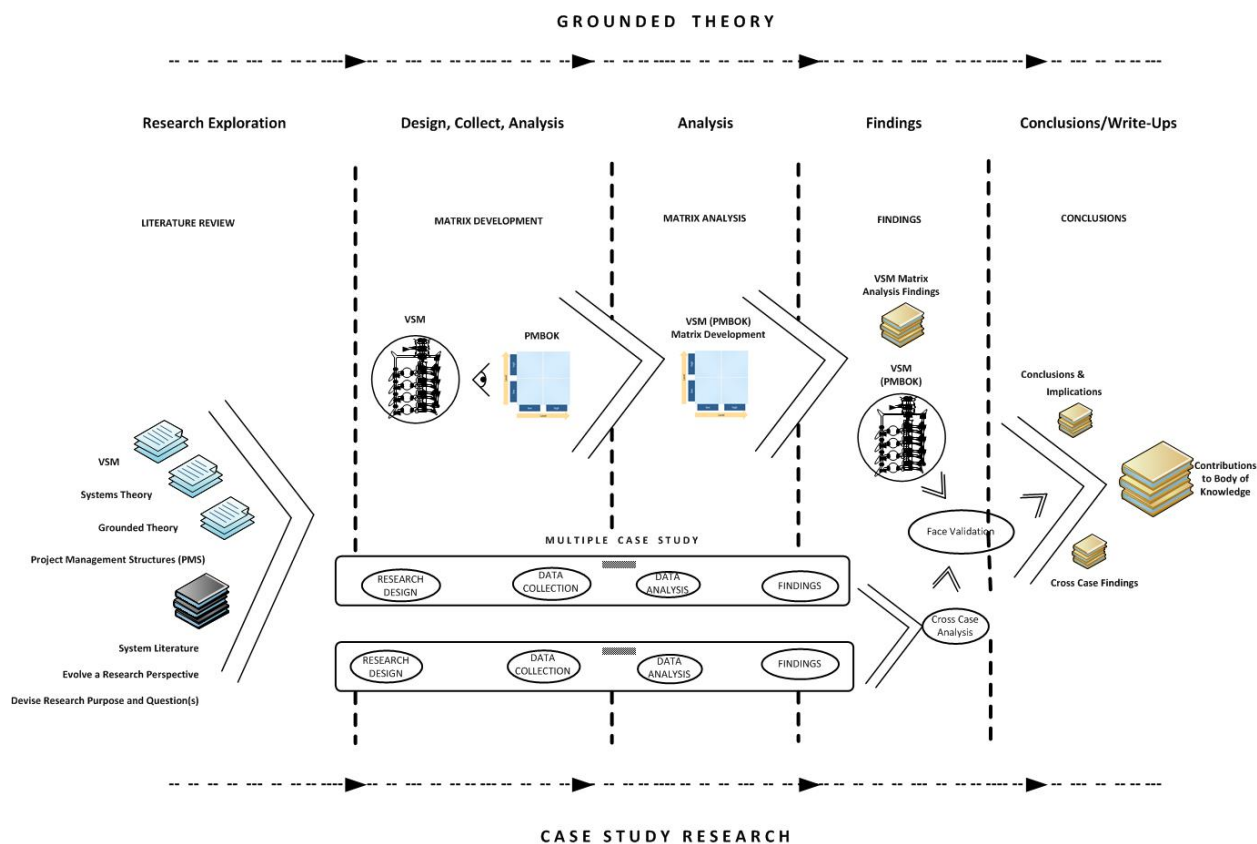

**Figure 17: Research Design**

## PHASE I OF THE RESEARCH DESIGN: FRAMEWORK DEVELOPMENT

Phase I of the research design examined the framework development of the VSM used in analysis with the framework associated with the PMBOK. The PMBOK framework was analyzed with each of the primary Systems and Channels associated with the VSM. The results were tabularized and discussed to discover what could be found by using the VSM to explore the PMBOK framework and structure from the viewpoint of management cybernetics. This development provided the frame of reference for application in the selected cases.

## **FRAMEWORK DEVELOPMENT**

The strategy pursued to develop a framework for project analysis was to provide a cross matrix review between the foundation guidance given within the Project Management Body of Knowledge (PMBOK) and the Viable System Model (VSM). The goal was to determine what differences may exist within PMBOK that the VSM may highlight as missing. To accomplish this effort the need to clarify the elements of the VSM that was used within the matrix needed to be clearly defined. The Five Systems and Six Primary Communication Channels associated with the VSM were the elements used as the frame of reference for application of the VSM framework. Each of the elements were described and visualized in reference to the VSM prior to establishing the matrix contents. Each area of PMBOK was then reviewed to determine whether elements of the VSM were truly addressed within PMBOK and to what extent. A simple scale of 0 to 3 was used within this matrix to begin to highlight a 'strength' or presence of these elements principle meanings within PMBOK. Chapter by chapter and section by section of PMBOK were reviewed through the VSM frame of reference. Once the matrix was completed, an analysis of the matrix took place with the goal of highlighting differences or missing/weak areas within PMBOK that the VSM may be able to highlight.

This phase of research required the researcher have a thorough knowledge of engineering management and the Project Management Body of Knowledge (PMBOK). Knowledge gained in a master's program in engineering management would ensure the principles and theories around engineering management have been attained, while an associated bachelor's degree in engineering discipline would support the assumption that the researcher is knowledgeable in their field of expertise. The PMBOK is the compilation of many experienced project managers in

different fields of expertise that share their knowledge in providing the framework for project management. Having thoroughly reviewed the PMBOK allowed the researcher to assess the PMBOK through the VSM frame of reference. Working experience in the field of engineering management would also enhance the depth and application of knowledge of engineering management to the assessment being able to cite real world examples. For this particular instance, 5 years minimum experience was considered a minimum acceptable level. Failure for the researcher to not have this education and work experience would not be consistent with the depth of knowledge considered essential to support construction of the framework and provide interpretation of classification of the case specifics for this effort.

The matrix elements were based on a simple numerical scale of '0', '1', '2', and '3'. The value '1' represented a weak link between the VSM and PMBOK that pertains to the section in PMBOK being viewed through the VSM frame of reference. Similarly, the value '3' represented a strong link between the VSM and PMBOK that pertains to the particular section in PMBOK being viewed through the VSM frame of reference. The value '2' represented a moderate link between the VSM and PMBOK that pertains to the section in PMBOK being viewed through the VSM foundations. A '0' indicates no link between the VSM and PMBOK that pertains to the section in PMBOK being viewed through the VSM frame of reference. The linkage was based on the referenced VSM material where direct correlations to the context are claimed.

The VSM can be characterized by its Five Systems and Six Primary Communication Channels. It is necessary to understand these elements of the VSM as they are part of the organization structure of the functional framework. Each system and channel was described, a representative diagram within the viable system was highlighted, and examples of functions that

help describe each element were provided. The researcher used this information and the knowledge of engineering management to assess the project frameworks. Examples of functions were derived from the VSM literature. Each model developed for a project represents a unique view of an organization's project team. The VSM framework was the basis for choosing the project model's parameters. The reviewed literature was the basis of the definitions used for developing the frameworks unique identifiers (associated with the systems and channels). It is this need for system knowledge and familiarization with the VSM that was required for the VMS to PMBOK PMS matrix analysis.

The framework development for application of the VSM for projects began by applying a matrix evaluation of the VSM compared with the structure of a project defined internal to the project. This is feasible due to the recursive nature of the VSM and its application at the project level of an organization. Similarly, PMBOK contains a compilation of PM work that strives to articulate project structure from the perspective of authorized project professionals. Each of the Five Systems of the VSM and associated communication channels were described and then transposed along the horizontal matrix. PMBOKs defined processes that make up the project structure was presented and appeared along the vertical axis. The VSM and Project Management Structure matrix was then analyzed to identify voids that may have existed between the VSM system structure and the structure as defined by the PMBOK.

The Viable System Model required one to look at the System-in-Focus. The System-in-Focus was the project level team of an organization. The System-in-Focus can be seen in Figure 18 below:

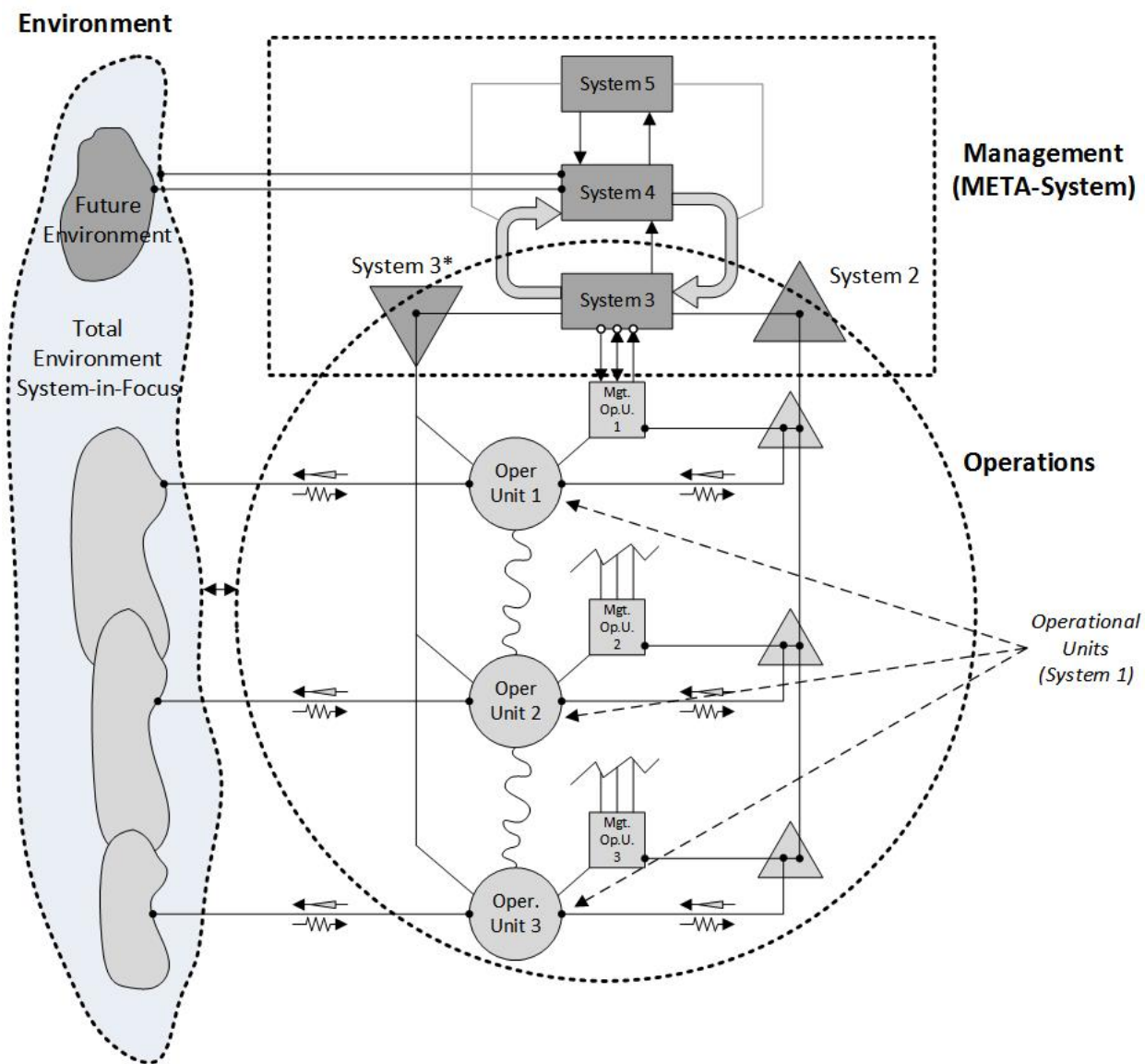

**Figure 18: VSM System-in-Focus {Adapted From Ríos, 2012, p. 130}**

**SYSTEM ONE**

System One (S1) is described as a bounded area within an organization that performs a specific function that implements a portion of the organizations main purpose. The System One’s

of a project being the system in focus were those areas defined as performing a specific function/operation that implements a portion of the project's main purpose. With the System-in-Focus, defined as the project level, the System One of an organization was described. System Ones of the VSM are the operational (productive) elements of the System-in-Focus. System One represented the operation that an organization performs to produce value of the system. System One descriptions that were used for the matrix development are described in the Table 8 below:

System	Definition(s)	Identifiers
S1	<p>Elements concerned with performing the key transformations of the organization; produces the products. (Beer, 1981)</p> <p>The autonomous unit that produces the product or service. (Beer, 1981)</p>	<ul style="list-style-type: none"> <li>- Produces the product or service; only systems that are autonomous/ viable by themselves. (Beer, 1981)</li> <li>- Operates autonomously within agreed parameters. (Keating, et al, 2012)</li> <li>- Produce systems product and services to agreed-upon standards and performance levels within the allocated resources. (Keating, et al, 2012)</li> <li>- Interface with S2 for coordination within the larger systems. (Keating, et al, 2012)</li> <li>- Provide direct interface to the local system environment. (Keating, et al, 2012)</li> </ul>

**Table 8: System One Identifiers**

Figure 19 below shows the VSM System one positioning highlighting its operation and management's functional area:



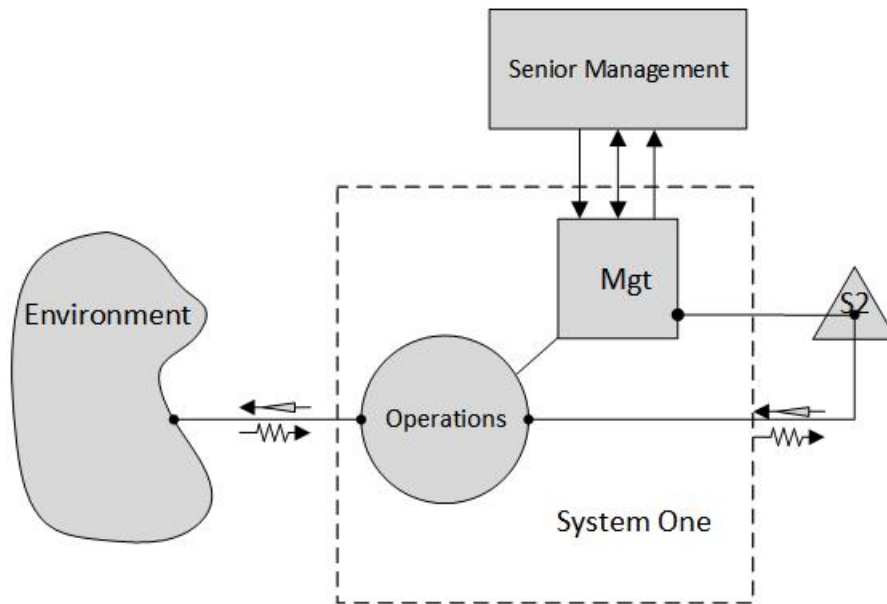

**Figure 19: VSM System One {Adapted From Ríos, 2012, p. 29}**

## SYSTEM TWO

System Two (S2) is described as the mechanism put in place that allowed other Systems One's to interface within and between one another. System Two also permits System Three to monitor activities within the System One's and helps to provide coordination efforts. System Two provides a scheduling function of shared resources to be used by the Systems Ones. The System Two provides anti-oscillation in an organization. System Two's of the organization are dependent on management as it deals with the whole of System One (Beer, 1985, p. 74). Each System One is served by more than one System Two as there are always several oscillatory

sources (Beer, 1985, p. 74). System Two descriptions that were used for the matrix development are described in Table 9 below:

System	Definition(s)	Identifiers
S2	Anti-oscillatory regulatory, input filter to S3. (Beer, 1981) Divisional/Corporate regulatory. (Beer, 1981, p. 157) Metasystem subsuming all S1's. (Beer, 198, p. 172)	<ul style="list-style-type: none"> <li>- Coordinator, preventing oscillations. (Beer, 1981 , p. 160)</li> <li>- Elaborate interface between S1 and S2. (Beer, 1981)</li> <li>- Monitors what S1 does. (Beer, 1981)</li> <li>- Input filter to S3. (Beer, 1981)</li> <li>- Services S1 and is not a command channel. (Beer, 1979)</li> <li>- Not routine services, but anti-oscillatory. (Beer, 1979)</li> <li>- Must be recognized by the observer. (Beer, 1979, p.189)</li> <li>- "To avoid explosion is minimally to constrain freedom". (Beer, 1979, p. 190)</li> <li>- Maintain coordination among S1's. (Keating, et al, 2012)</li> <li>- Promote system efficiency amongst S1s. (Keating, et al, 2012)</li> <li>- Identify and manage emergent conflict between S1s. (Keating, et al, 2012)</li> <li>- Identify system integration issues for system level resolution. (Keating, et al, 2012)</li> </ul>

**Table 9: System Two Identifiers**

Figure 20 below shows the System Two components:

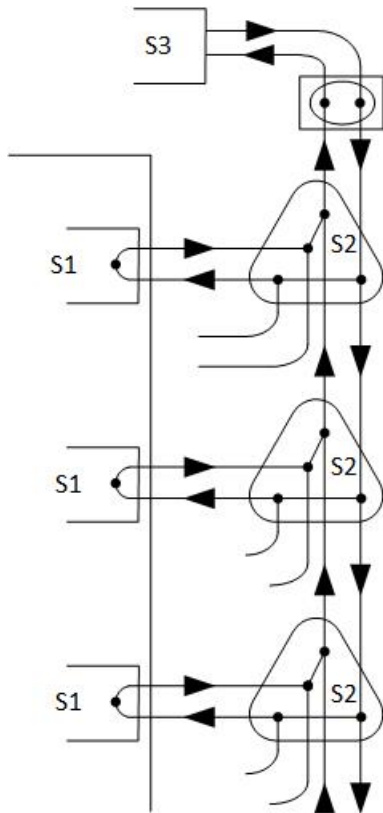

**Figure 20: VSM System Two {Adapted From Beer, 1981, p. 173}**

### **SYSTEM THREE**

System Three (S3) presents the structures and controls that are put in place to establish the rules, resources, rights, and responsibilities for System One. System Three provides the interface to the System Four and System Five to the System Ones. System Three provides the big picture view of the processes within the System One. System Three Star (S3\*) is able to audit the

System Ones where System Three is responsible for the internal and immediate functions of the organization. System Three provides the 'here-and-now' and the 'day-to-day' management within an organization (Beer 1985, p. 86). S3 is responsible for but does not conduct the anti-oscillatory functions of System Two (Beer, 1985, p. 86). S3 manages the resource bargaining between the System Ones and is responsible for the audits that System Three\* Star performs. System Three descriptions that were used for the matrix development are described below in Table 10:

System	Definition(s)	Identifiers
S3	<p>Provides interface with S4 and S5 structures and controls that establish rules, resources, rights, and responsibilities of S1. (Beer, 1982)</p> <p>Operative management. (Ríos, 2012)</p> <p>Highest level of autonomic management. (Beer, 1981, pp. 175-176)</p> <p>Lowest level of corporate management. (Beer, 1981)</p> <p>Govern the stability of the internal environments of the project. (Beer, 1981)</p> <p>Transmitter of policy/special instructions to the divisions. (Beer, 1981)</p> <p>Tracer of information of internal environment: metasystem controller downward, senior filter of information upward.</p> <p>Handles S2 information circuits. (Beer, 1981)</p>	<ul style="list-style-type: none"> <li>- Highest level of autonomic magnet and the lowest level of corporate management of the systems in focus. (Beer, 1981, p. 175)</li> <li>- Transmitter of policy and special instructions to the divisions/S1s. (Beer, 1981, p. 176)</li> <li>- Recover of information of the internal environment; sends information upwards and downwards; only recovery of information upward from S2. (Beer, 1981, p. 176)</li> <li>- Aware of what's going on inside the firm now. (Beer, 1979, p. 202)</li> <li>- Manage the 'here and now' of the organization. (Ríos, 2012)</li> <li>- Describing the channels between S4 and S3. (Ríos, 2012)</li> <li>- Facilities resources communications between representatives from S3 and S4. (Ríos, 2012)</li> <li>- Methodological and functional communications through models and tools. (Ríos, 2012)</li> <li>- Setting goals. (Ríos, 2012)</li> <li>- Negotiating resources. (Ríos, 2012)</li> <li>- Accountability procedures. (Ríos, 2012)</li> <li>- Marketing's, sales, human resources, productivity and quality, production and operation, engineering, accounting, budgeting. (Ríos, 2012)</li> <li>- Handles divisional interactions. (Beer, 1981)</li> <li>- This is where the financial director, a production director, and as sale director would operate. "Each of them is setting out to integrate the work foot he respective divisional managers". (Beer, 1979, p. 201)</li> <li>- Operational planning and control for ongoing system performance. (Keating, et al, 2012)</li> <li>- Interprets and implements policies from S5, Interfaces with S4 to redesign operation in response and identification of environmental changes. (Keating, et al, 2012)</li> </ul>

**Table 10: System Three Identifiers**

Figure 21 below highlights the System Three's within the VSM:

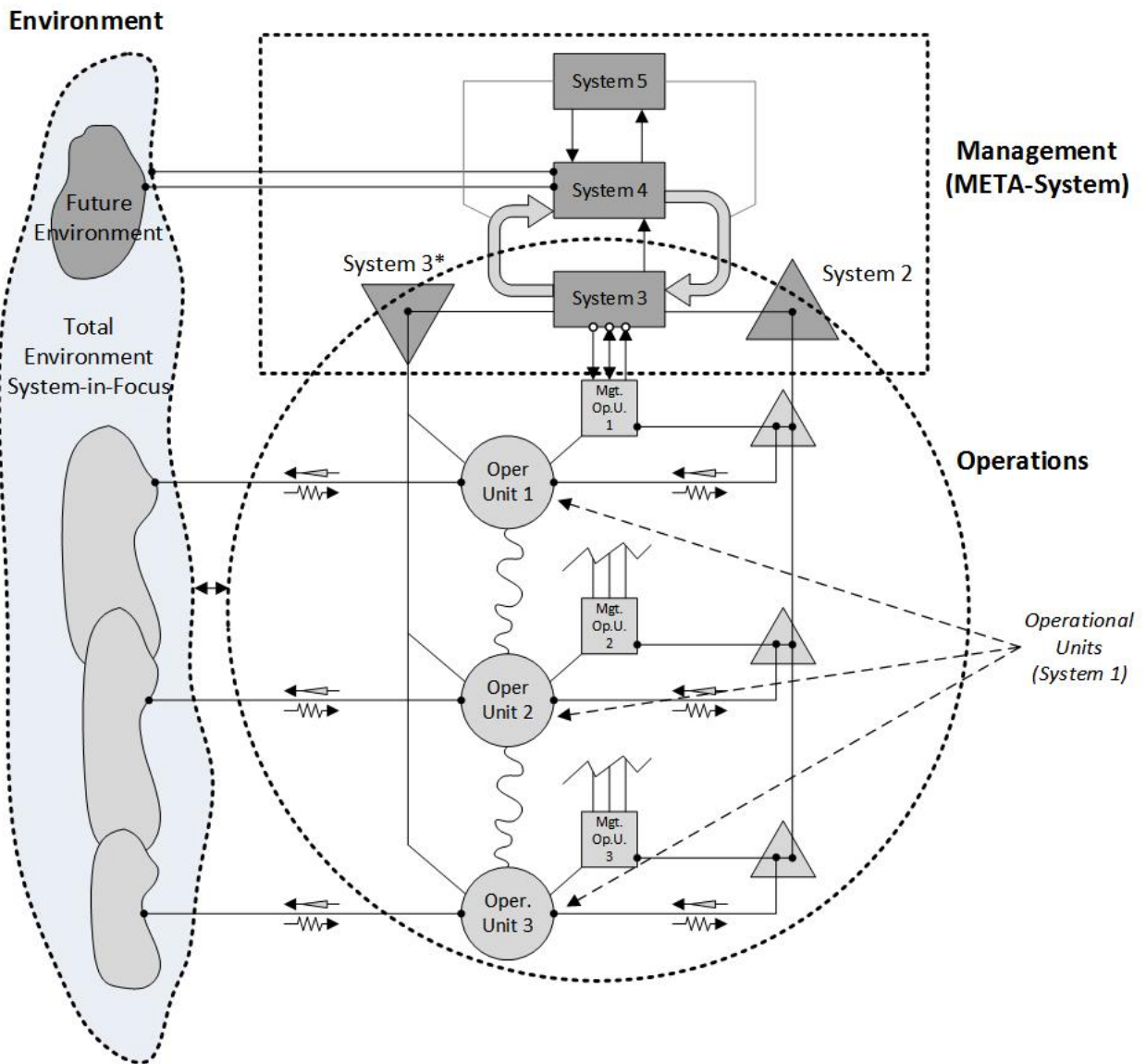

Figure 21: VSM with Systems Identified {Adapted From Ríos, 2012, p. 107}

System Three acts both as a management element to the System One's, but also is part of the management associated with the S3-S4-S5 metasystem.

### **SYSTEM THREE \* (STAR)**

System Three \* (Star) (S3\*) is responsible for the internal and immediate functions of the organization. While System Three provides the 'here-and-now' and the 'day-to-day' management within an organization. System Three\* provides for the audit of these functions (Beer, 1985). System Three Stars are a part of System Three and “are not separable from System Three itself, except for the fact that they operate – by consensus – APART from the command function” (Beer, 1985, p. 86). System Three handles the accounting. System Three descriptions that were used for the matrix development are described below in Table 11:

System	Definition(s)	Identifiers
S3*	Audit channel. (Beer, 1981)	<ul style="list-style-type: none"> <li>- Highest level of autonomic magnet and the lowest level of corporate management of the systems in focus. (Beer, 1981, p. 175)</li> <li>- Transmitter of policy and special instructions to the divisions/S1s. (Beer, 1981, p. 176)</li> <li>- Recover of information of the internal environment; sends information upwards and downwards; only recovery of information upward from S2. (Beer, 1981, p. 176)</li> <li>- Monitor Subsystems and system level performance. (Keating, et al, 2012)</li> <li>- Identify and analyze deviant performance, unexpected crisis, and operational conditions and trends. ( Keating, et al, 2012)</li> </ul>

**Table 11: System Three\* (Star) Identifiers**

**SYSTEM FOUR**

System Four (S4) represents the structures put in place to monitor the environment and the organization itself to ensure it is able to remain viable. System Four is concerned with the management of the ‘outside-and-then’ and works to provide self-awareness for the System-in-Focus (Beer, 1985, p. 115). System Four interfaces with System Five, the ultimate authority. System Four descriptions that were used for the matrix development are described below in Table 12:



System	Definition(s)	Identifiers
S4	<p>Development directorate of the organization. (Beer, 1981, p. 181)</p> <p>Detecting and conveying changes and needs determined by the evolution of the environment and conveying this to the interior organization. (Ríos, 2012)</p> <p>Strategic management. (Ríos, 2012)</p> <p>Elements which look outward to the environment to understand how the organization needs to adapt to remain viable. (Beer, 1981)</p>	<ul style="list-style-type: none"> <li>- A description of management and individual's purpose is S4. (Ríos, 2012)</li> <li>- Explicit descriptions of activities that each individual does for S4. (Ríos, 2012)</li> <li>- Means that organization supports S4 efforts. (Ríos, 2012)</li> <li>- Simulation models, tools for carrying out prospective studies, methods employed to explore alternative decisions, decision area. (Ríos, 2012)</li> <li>- Elements or physical visualizations of past/present/modeled data for decision making. (Ríos, 2012)</li> <li>- Environment areas to account for include: commercial, social, demographic, technological, political, legal, economic, ecological, and educational. (Ríos, 2012)</li> <li>- Sensor, transducers channels of communications analysis of how to make these work. (Ríos, 2012)</li> <li>- Awareness of how data/information is captured viewed/presented and associated characteristics. (Ríos, 2012)</li> <li>- Review of vision, mission, objectives, business model, profitable growth areas, new challenges, and chances for transformation as desired, expansions, etc. (Ríos, 2012)</li> <li>- Information switch between S3/S5 filtered. (Beer, 1981)</li> <li>- Foster strategic learning, development, and transformation. (Keating, et al, 2012)</li> <li>- Maintain environmental scanning, analysis, and interpretation. (Keating, et al, 2012)</li> <li>- Maintain models of the systems for other subsystems and the environment; guides system transformation; identify system trends and patterns. (Keating, et al, 2012)</li> </ul>

**Table 12: System Four Identifiers**

**SYSTEM FIVE**

System Five (S5) is responsible for policy decisions and propagates, maintains, and develops the identity of the organization. System Five balances the demands within the organization and helps to steer the organization as a whole. One should remember that ‘the purpose of a system is what it does’ and what the viable system does is done within the System Ones. System Five is ‘only’ thinking about it (Beer, 1985, p. 128). System Five is the ultimate authority of the system. System Five descriptions that were used for the matrix development are described below in Table 13:

System	Definition(s)	Identifiers
S5	<p>Responsible for policy and decisions. (Beer, 1981)</p> <p>"Collegiate authority" (Beer, 1981, p. 154)</p> <p>Provides the identity of the organization. (Beer, 1981)</p> <p>Responsible for achieving equilibrium between the present functioning of the organization and its preparation for the future. (Ríos, 2012)</p> <p>Creates policy decisions within the organization as a whole to balance demands from different organizations and provide direction to the organizational as a whole. (Beer, 1982)</p> <p>Normative management. (Ríos, 2012)</p>	<ul style="list-style-type: none"> <li>- Looks at needs of divisions and may sacrifice resources for the greater good. (Beer, 1981, p. 160)</li> <li>- Operations room environment available. (Beer, 1981)</li> <li>- Provides Identity of the organization. (Beer, 1981)</li> <li>- Resources that actually make up S5 identified. (Ríos, 2012)</li> <li>- Procedures to communicate strategic plan/identity to the organization. (Ríos, 2012)</li> <li>- Are channels in place to communicate S5 needs, sensors, emergency access to S5; i.e. functional. (Ríos, 2012)</li> <li>- Interaction between S3/S4 with S5 to maintain equilibrium/resolve S3/S4 issues. (Ríos, 2012)</li> <li>- Develop system policy and direction. (Keating, et al, 2012)</li> <li>- Strategic goals/objectives written. (Ríos, 2012)</li> <li>- Monitors vertical command axis for obeying instructions. (Beer, 1981, p. 159)</li> <li>- Formal declaration of vision, mission, purpose. (Ríos, 2012)</li> <li>- Represent and communicate the system to external entities; process input/outputs forms other subsystems; establish system policy and strategic direction. (Keating, et al, 2012)</li> <li>- Propagate system identity; maintain and propagate mission/vision/identity. (Keating, et al, 2012)</li> <li>- Balance systems focus between S3 and S4 (now and future). (Keating, et al, 2012)</li> </ul>

**Table 13: System Five Identifiers**

## VSM SIX PRIMARY COMMUNICATION CHANNELS

In addition to the functions of the VSM, the other primary aspect is the operation of the communication channels. The Six Primary Channels of Communication highlighted within the VSM are described below (Ríos, 2012, p. 61):

- C1 Absorption channel between the S1's and their individual environment.

- C2 Channel connecting the various operational units.
- C3 Corporate intervention channel.
- C4 Resource bargaining channel.
- C5 Anti-oscillatory channel.
- C6 Monitoring channel.

Tables 14-20 below provide a definition and identifiers that were used in the matrix analysis between the VSM and PMBOK PMS for each of the six primary communication channels of the VSM:

VSM		
Channel	Definition(s)	Identifiers
C1	Channel connecting and absorbing variety between the environments of each elementary unit. (Ríos, 2012, p. 61)	<ul style="list-style-type: none"> <li>- Communicating S1s to the environments. (Ríos, 2012, p. 61)</li> <li>- Connection channel and variety absorption for the environment for each S1. (Ríos, 2012, p. 61)</li> <li>- One of the Vertical Channels. (Ríos, 2012, p. 61)</li> </ul>

**Table 14: Channel One Identifiers**

VSM		
Channel	Definition(s)	Identifiers
C2	Channel connecting the various elemental operations (operational units making up S1). (Ríos, 2012, p. 61)	<ul style="list-style-type: none"> <li>- Communications between the S1's used for coordination and information exchange. (Ríos, 2012)</li> </ul>

**Table 15: Channel Two Identifiers**

VSM		
Channel	Definition(s)	Identifiers
C3	Corporate intervention channel; S3-S1 (Ríos, 2012, p. 61)	<ul style="list-style-type: none"> <li>- Communication channel between S3 and S1 providing corporate updates. (Ríos, 2012)</li> <li>- Defines management style used with this channel. (Ríos, 2012)</li> </ul>

**Table 16: Channel Three Identifiers**

VSM		
Channel	Definition(s)	Identifiers
C4	Resource bargaining channel; S3-S1. (Ríos, 2012, p. 61)	<ul style="list-style-type: none"> <li>- Communication Channel between S3 and S1 used for resource bargaining. (Ríos, 2012)</li> <li>- Negotiation of resources. (Beer, 1981)</li> </ul>

**Table 17: Channel Four Identifiers**

VSM		
Channel	Definition(s)	Identifiers
C5	Anti-oscillatory channel (Coordination) S2. (Ríos, 2012, p. 61)	<ul style="list-style-type: none"> <li>- Coordination between S2's and S1's. (Ríos, 2012)</li> <li>- Anti-Oscillatory. (Beer, 1981)</li> <li>- Resolve conflicts between S1's. (Ríos, 2012)</li> </ul>

**Table 18: Channel Five Identifiers**

VSM		
Channel	Definition(s)	Identifiers
C6	Monitor Channel (Auditor). (Ríos, 2012, p. 61)	<ul style="list-style-type: none"> <li>- Monitoring and Control. (Beer, 1981)</li> <li>- Auditing channel. (Beer, 1981)</li> <li>- Completes the equation that balances the variety absorbed by the six vertical channels. (Ríos, 2012)</li> <li>- Direct channel between S3 and S1's with no filtering. (Ríos, 2012)</li> </ul>

**Table 19: Channel Six Identifiers**

VSM		
Channel	Definition(s)	Identifiers
Algedonic	Named from 'algo' meaning 'pain' and 'donic' meaning 'pleasure'. Refers to the information system that runs parallel to all the vertical channels whose aim is to transmit alert signals concerning any event or circumstance that could seriously jeopardize the organization. (Ríos, 2012, p. 61)	<ul style="list-style-type: none"> <li>- Signaling outside normal operating channel advising of concerns. (Ríos, 2012, p. 62)</li> <li>- Emergency channel for the different system to get to S5 as needed. (Beer, 1981)</li> <li>- Information channel that runs parallel to all the vertical channels. (Ríos, 2012, p. 62)</li> <li>- Transmits alert signals concerning any event or circumstance that could seriously jeopardize the organization. (Ríos, 2012, p. 63)</li> </ul>

**Table 20: Algedonic Channel**

The six primary communication channels for the VSM were described in this section. Each channel definition was given and sourced from the literature. Identifiers for real life applications as described in the literature were provided for each of the six primary communication channels. This information was the basis for the matrix analysis that would occur

in this research contrasting the VSM with the PMS framework (as described in the PMBOK).

The next section describes the data analysis using the modified VSM.

### **DATA ANALYSIS USING THE MODIFIED VSM**

The modified VSM helped to both capture and interpret the project management structure for a project. The project management structure was presented in terms of the VSM and how it related to structure. The modified VSM model was used to identify structural issues within a project.

The Modified VSM framework was used for the analysis of the Project Management Structure and the three functional areas as defined by PMBOK (2013): (1) PM Framework; (2) PM Process In/Out; and (3) PM Knowledge Areas. The three areas defined by the Project Management Institute (PMI) associated with the project management structure of projects was the focus area for PMS analysis using the adapted VSM for this research effort. The VSM to PMBOK PMS was analyzed section by section from the PMBOK and determined direct relevance to the VSM and noted the level to which there was consistent coverage between the two structural representations. The results of this effort are presented in Section V, Summary of VSM to PMBOK PMS Analysis of Matrices. The next section of the research, Phase II, looked at the research design associated with the case study research portion of this dissertation.

## **PHASE II OF THE RESEARCH DESIGN: CASE STUDY DEVELOPMENT PHASE**

This section develops the research design based on the methodological foundation presented in Chapter III for case study research. The case study method was chosen for the research because case study research is suited to provide the face validation of the results of the VMS to PMBOK PMS analysis accomplished in Phase I. The methodology developed by Yin (2009) was chosen as the basis of CSR for this research effort. Other prominent researchers have used case study research to include Corbin and Strauss (2008), Creswell (2009), Denzin and Lincoln (2005), and Stake (1995, 2006). Yin (2009) was chosen as a single source of reference for replication. The purpose of this study was to apply the VSM to analysis of the PMS associated with PMBOK framework. The case study method was appropriate as it met the general criteria according to Yin (2009, p. 2)

1. When 'how' and 'why' questions are poised.
2. The investigator has little control over events.
3. The focus is on a contemporary phenomenon within a real-life context.

The first research question was: How the Viable System Model (VSM) could be adapted for analysis of project management structure?

The second research question was: What results from exploration of the Viable System Model framework application to active project management structures?

Additional perspectives for analyzing project management structures can help to provide theoretical results which will add to the body of knowledge. Using the case study as a research design approach offers researchers a novel methodology for analyzing project management structures. The six phases of the research included:



1. Selection of cases.
2. Data collection during the case study.
3. Construction of the database using the modified VSM framework.
4. Drafting the case narratives using evidence from the case study databases.
5. Verification of the accuracy of the case narratives by selected participants.
6. Cross case analysis.

A graphical presentation of the research design for case study application is shown in Figure 22 below:

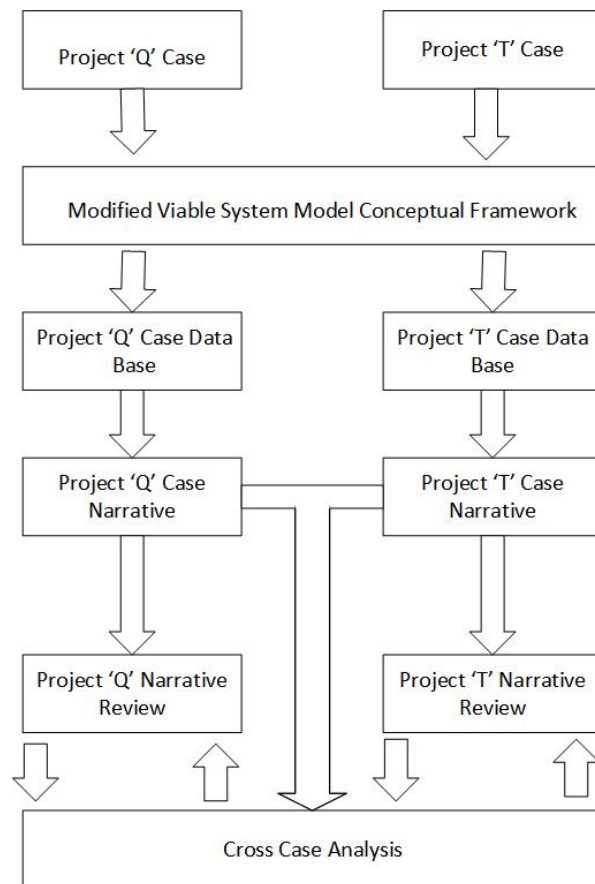

**Figure 22: Research Design**

The research design defined the protocol elements that were used to perform the multiple case studies. Yin (2009) explained the need for the protocol to address the case study in terms of an overview, the field procedures, the case study questions, and the investigator guide for the case study report. This design was accomplished by following a defined case study protocol whose elements are provided below and explained in detail subsequently in the document:

1. Selection of case studies used for analysis.
2. Data collection strategies.
3. Role of the researcher
4. Researcher skills.
5. Time boundaries.
6. Stakeholder issues.
7. Method of achieving validity and reliability.
8. Appropriateness of data.
9. Relationship of the data to the case study objective
10. Case study database construction.
11. Case narrative construction.
12. Case verification.
13. Cross case analysis.
14. Interpretation of results

Two case studies were performed on projects within the organization. The purpose of replication was to show similar results could be achieved using the same procedures done under similar circumstances following guidance of Yin (2009). The research design previously

provided in Figure 22 visualizes the process used from the case selection through the cross case analysis element of the case study research. The following sections expand and define the functional features of the case study protocol elements used in this research effort.

## **SELECTION OF CASE STUDIES USED FOR ANALYSIS**

This research effort analyzed the project structure as the system in focus of a civilian government engineering services activity within the Hampton Roads area. The unit level of analysis was defined to be at the project level. The selected projects allowed the researcher access to the individual work products generated during the operation of the project and development that enabled the researcher to fully understand the in depth details of the project. The researcher was able to capture the data based on the project team's inputs and how they communicated in the project environment. The researcher captured the description of the contextual setting of the project and was able to also describe the physical environment in which the project operated. The researcher was able to make attributions for research purposes based on the documents provided for the review. The researcher was also able to collect direct answers from documents written in support of project performance. The projects were chosen based on the criteria provided in the Research Methodology chapter, shown below for ease and further clarified in the following paragraphs:

1. Engineering group in the federal government responsible for project tasking.
2. Funded effort; at least \$75 thousand Level of Effort (LOE), not to exceed \$5 Million (LOE).
3. Project was not in its initial formation phase.

4. Project was not in a close out phase.
5. Have a clear project manager, government team of ranging between 3 to 12 members.
6. Active project.
7. Access to personnel for case narrative face-validation and documentation.

Two active projects were chosen that represent engineering groups in the federal government responsible for project tasking. These projects were referred to as 'Project Q' and 'Project T'. 'Project Q's' funding level was \$543K and 'Project T's' funding level was \$953K, both falling within the \$75K to \$5M range. Both projects were within their operational sustainment phase of the project life cycle and were considered mature; neither was in initial formation phase nor in a close out phase. 'Project Q' had 12 members on the team and 'Project T' had 11 members on its team, thus falling within the desired range of 3 to 12 members. The quantity of government members on the team when first developing the limitations were based on discussions that an optimal Integrated Product Team (IPT) would have 12 members. Upon further review, the quantity maximum was expanded to 18 members. This was not considered to be an impact as the initial assumption of government team members were considered to be all technical; and did not take into account the non-technical support members. For replication purposes this boundary was chosen. These government employees were fulltime or had identified the project as their primary project effort. This decision to change the number of team member as a boundary was because people have been known to work multi-projects. The government project teams were members that had decision level input to the project lead (lead project manager for the effort). This is unlike contract support members who are constrained by contractual agreements (contracts formulated by the government team members). Both projects

had agreed to this study and were willing to provide access to personnel for case narrative review and documentation. The discussion group should consist of the government team members that have decision-making authority. Decision makers naturally make the decisions; this guides the organization. The next section looked at the data collection strategies for these case studies.

## **DATA COLLECTION STRATEGIES**

Case study research, as the design methodology for this research, needed to collect data during the research effort based on a rigorous design to be followed to ensure validity and the ability for the reader/researcher to fully understand how the data was collected (Corbin and Strauss, 2008; Yin, 2009). This section describes the sources of data used and establishes what was accomplished to ensure validity and reliability of this data for this research effort.

One of the foundation elements of any research effort is the data that is collected (Yin, 2009). The case study protocol was used to collect data from the projects and helped build the rigorous foundation characteristics necessary to establish validity and reliability for this case study research. Yin (2009) refers to source data as “sources of evidence”. Some of the most commonly used sources of evidence used in case study research, which were used in this research effort are referred to as “six sources of evidence” (Yin, 2009, pp. 101-113):

1. Documentation.
2. Archival Records.
3. Interviews (discussions) for professional opinion and face-validation.
4. Direct Observations.
5. Participant Observation.

## 6. Physical Artifacts.

Documentation, the written word, is a critical part of any case study research and may take many forms (Yin, 2009). The importance of organizing the gathered information and the selection of the information to be gathered is part of what a case study researcher does (Yin, 2009). Some examples may include email, memorandums, faxes, and newsletters.

Archival records are stored records that can be used by the researcher for case study researcher (Yin, 2009). Archival records may include stored files, stored purchase orders, and organizational charts. The projects provided stored data on the projects from internal websites, databases, and stored files. The files are shown in the bibliography sections of each case narrative and included stored items such as meeting minutes and organizational charts.

The discussions process is another potential source for the collection of case evidence. Yin (2009) describes these “guided interviews” (discussions) as being fluid, but focused. The focus requires the researcher to follow the case study protocol developed for the case study and to be unbiased when asking questions (Yin, 2009). Discussions were performed to gather information on the PMS of these projects and how communication within the project occurred. Discussion data was placed into the case study database. The case study database data was later used in the development of the case narratives.

Direct Observations of a case study in its natural settings can range from a formal to an informal event. The researcher was allowed to observe daily events such as meetings, allocation of resources, and participants work settings. Observations of the lab environment, office environment, and customer interactions were observed and documented.

Participant-Observation can be used when the researcher is not only an observer of the event, but also is part of the event being observed. One benefit of the participant-observer is the ability to observe what might be otherwise unavailable for observation. At times, the researcher used this opportunity to review the status and well-being of the projects in the role of a Sub Portfolio Lead. A Sub-Portfolio Lead (SPL) is a portfolio manager that manages multiple Integrated Product Teams (IPTs) within an organization. The IPT leads manage multiple projects. Within an organization the goal is to group similar projects within an IPTs which get further combined for management within Sub-Portfolios (SP). To note, SPs are themselves a subset of the Portfolio, the highest grouping within the organization in focus. This allowed the researcher to be aware of the particular applicable parts of meetings and events that might not otherwise have been available to others.

Physical Artifacts are another source of evidence which may be “a technological device, a tool or instrument, or work of art, or some other physical evidence” (Yin, 2009, p. 113). Actual observation of the lab equipment used for the project and the related test equipment allowed the researcher to gain insight into the job requirements and the associated allocation of these resources amongst the project tasks.

For this research effort, the sources of evidence are given in Table 21 below:

Source of Evidence	Project Evidence
Documentation.	Emails. Standards/Guidelines/PMP. Project Updates/Reviews. Project Reports. Weekly Reports/Minutes.
Archival Records.	Drawings. Database Access. Organizational charts. Contracts/Purchase orders/Financial Documents.
Project Team Views	Face-validation of case narrative and PMS data sources.
Direct Observations.	Observation of meetings, work environment, daily interactions, labs.
Participant Observation.	Meetings, Lab environment, project site, email.
Physical Artifacts.	Project symbols, lab equipment.

**Table 21: Sources of Evidence**

Data collection steps included setting the boundaries for the study, collecting information (observations and interviews, documents, and visual materials), and establishing the protocol for recording information (Creswell, 2009, p. 177). These procedures were needed to maintain rigor in the research effort. The boundary setup for the collection of the project data included the following:

1. Data analysis period was a 2-week snapshot in time.
2. Data was from project team members and agreed resource areas.
3. Agreed review of information attained.



#### 4. Agreement to case study draft review.

The case study database was used to organize and document all data for analysis. An example of a case study evidence entry can be seen in Appendix 7. Each project lead was aware of all data that was used for this case study to ensure accuracy and accountability.

### **ROLE OF THE RESEARCHER**

For case study research, the researcher was the instrument of discovery for this qualitative research. The researcher had a large responsibility to be objective and unbiased in the collection of data. The researcher used the case study protocol to collect and validate the data collected as part of a rigorous research effort. The data from documentation provided by the IPT leads was reviewed and incorporated into the case study database. Discussion data, meetings and all other documentation were also incorporated into the case study database. The researcher used this data to create the case study narratives. The researcher was the conduit to collect unbiased data related to the PMS of the project-in-view.

The researcher presented to the project team the reason for the case study. The researcher presented background information on the researcher's education and work experience to help clarify the role of the researcher and articulate the needed credentials for this study. The researcher's educational background included a Bachelor's of Science degree in Electrical Engineering and a Master's degree in Engineering Management both from Old Dominion University. The researcher has worked as a project engineer for over twenty nine years at a government engineering activity. The researcher has been through all phases of organizational change within this civilian organization as it continues to support the Navy with engineering and

technical support projects. The researcher has thorough knowledge of the VSM, PMS, and PMBOK. The researcher's case study training was attained through education, self-study primarily of Yin's/Creswell's case study research techniques, and by individual case study research performed as part of the researcher's work experience. This research applied the abilities of the researcher's lifelong education and work experience in the undertaking of this study.

The researcher analyzed the projects within the chosen organization as part of a case study research effort. The researcher examined the feasibility of examining the project using the Viable System Model (VSM) to determine project management system structure and viability of this project within the organization. The unique access to project structures within a government engineering organization provided unique insight into the project's structure that outsiders would not otherwise be able to capture. The researcher's knowledge of the organization and projects within that organization allowed the selection of projects that could provide valuable insight into project management structures. The researcher's insight into the organization was seen to be beneficial to the study as the researcher knew where to ask important questions and find fruitful data to support the research. The author as researcher provided direct observation opportunities from meetings and daily work routines. Discussions with key personnel within the project offered insight into structures within the project. The researcher used key questions during the discussions that developed during the protocol phase. These questions pointed towards the understanding of the organizational structure of the project as developed through a VSM perspective to give unique insights into this project from the project member perspectives.

Each of the two project leads were given a participation request as seen in Appendix 08 and 09; respectively. The project teams were advised they could opt out at any time. My advisor was given as a POC as was my supervisor's information should any participant need that information. The researcher maintained communication with the organization's POC for this type of research to ensure the researcher acted within the guidelines of the organization.

### **CASE STUDY RESEARCHER SKILLS**

To perform this research, the case study researcher should be prepared to do case study research. Commonly desired skills required for a good case study researcher are given below by Yin (2009, p. 69) {The author as researcher confirms to have these skills}:

1. A good case study investigator should be able to ask good questions – and interpret the answers.
2. An investigator should be a good “listener” and not trapped by her or his own ideologies or preconceptions.
3. An investigator should be adaptive and flexible, so that newly encountered situations can be seen as opportunities, not threats.
4. An investigator must have a firm grasp of the issues being studied, even if in an exploratory mode. Such a grasp reduces the relevant events and information to be sought to manageable proportions.
5. A person should be unbiased by preconceived notions, including those derived from theory. Thus, a person should be sensitive and responsive to contradictory evidence.

The researcher unique ability and knowledge of the organization of study helped to identify potential area and personnel from which to gather information. Knowing where to ask and persistence to ask organizational participants was a unique advantage of being part of this organization. In response to the Yin's five areas that help define a good case study researcher, the following is offered as support for this claim:

1. A good case study investigator should be able to ask good questions – and interpret the answers.

Answer: The researcher has 29 years of work experience as a project engineer where daily involvement with customers, co-workers and all stakeholders of major projects has been an ongoing effort of asking good questions and interpreting the answers on behalf of the project. Course work associated with the electrical engineering and engineering management schools of Old Dominion University have provide a broad foundation of knowledge that is applicable to this area of research.

2. An investigator should be a good “listener” and not trapped by her or his own ideologies or preconceptions.

Answer: The researcher has 29 years of work experience as a project engineer where daily involvement with customers, co-workers and all stakeholders of major projects has been an ongoing effort of listening to stakeholders on behalf of the project. Course work associated with the electrical engineering and engineering management schools of Old Dominion University have provide a broad foundation of knowledge that is applicable to this area of research.

3. An investigator should be adaptive and flexible, so that newly encountered situations can be seen as opportunities, not threats.

Answer: The researcher has 29 years of work experience as a project engineer where daily involvement with customers, co-workers and all stakeholders of major projects has been an ongoing effort of being adaptive and flexible, so that newly encountered situations can be seen as opportunities, not threats on behalf of the project. Project requirements frequently change. Course work associated with the electrical engineering and engineering management schools of Old Dominion University have provide a broad foundation of knowledge that is applicable to this area of research.

4. An investigator must have a firm grasp of the issues being studied, even if in an exploratory mode. Such a grasp reduces the relevant events and information to be sought to manageable proportions.

Answer: The researcher has 29 years of work experience as a project engineer where daily involvement with customers, co-workers and all stakeholders of major projects has been an ongoing effort of being adaptive and flexible, so that newly encountered situations can be seen as opportunities, not threats on behalf of the project. Project requirements frequently change or need to be derived. Having full knowledge and intuitive knowledge of the sponsor or customer allows the project lead to have a firm grasp on project issues. Course work associated with the electrical engineering and

engineering management schools of Old Dominion University have provide a broad foundation of knowledge that is applicable to this area of research.

5. A person should be unbiased by preconceived notions, including those derived from theory. Thus, a person should be sensitive and responsive to contradictory evidence.

Answer: The researcher has 29 years of work experience as a project engineer where daily involvement with customers, co-workers and all stakeholders of major projects has been an ongoing effort of being adaptive and flexible, so that newly encountered situations can be seen as opportunities, not threats on behalf of the project. Project requirements frequently change or need to be derived. Having full knowledge and intuitive knowledge of the sponsor or customer allows the project lead to have a firm grasp on project issues. Being knowledge of sensitive to customer needs while providing subject matter expertise to the problem statements allows the project lead to be open to the best solution sets for the associated stakeholders. Course work associated with the electrical engineering and engineering management schools of Old Dominion University have provide a broad foundation of knowledge that is applicable to this area of research.

The researcher thus has met the five experience elements as described by Yin (2009) above.

## **TIME BOUNDARIES**

The time frame for the case study direct observation was limited to a two week period per project (based on project selection). Data gathering occurred prior to the entire case study period

as needed. Data gathering was in the form of real-time observation, interviews (discussions), and data gathering of project documents. Follow on data gathering was focused on this specific period; gathering emails, reports, and documents of this period that may otherwise not have been readily available to the researcher. Clarification of the data collected during this period was conducted beyond this period as needed to accomplish the construction of the case narratives. The important factor of the time boundary was that the project be in a stable phase, the operational phase. In a changing environment, a defined period of time for this collection effort is deemed reproducible and consistent with expectations.

A discussion guide was developed and used to encourage only discussions of the project management system structure and views during the period of analysis. Post observations were based on additional information and influences that were not available at the time of discussion. The need to identify and capture issues as they developed and how they were solved and/or mitigated was perceived as valuable as insights into the project management structure of the project. Clarification of the data discussions and captured data occurred during follow-up visits. The two week period of data collected was seen as forming a discussion boundary. Follow-up visits were no longer needed when the researcher reached a point of saturation from the data collected.

## **STAKEHOLDER ISSUES**

The decisions made within the projects affect the entire project, organization and associated customers. Therefore, stakeholders were found at all levels within the organization and the environment. The researcher was also a stakeholder since, as noted above; the researcher

had an interest in the outcome of the decisions. The researcher actually works for the organization and supported the one of the projects in some capacity. The project lead was considered the most important stakeholder as the project lead had contact with both the internal and external stakeholders and helped drive the project management structure. The project lead was the defined leader of the project (i.e., project manager). Understanding and documenting stakeholders concerns within the boundary of PMS was a focus of the researcher.

### **METHOD OF ACHIEVING VALIDITY AND RELIABILITY**

The researcher began by choosing a project that meets the project selection criteria. The VSM model for this research was adapted as a framework for the structural analysis of project management systems. The adapted VSM was then used in a case study research analysis of an actual project with results of this exploratory effort documented and analyzed following the rigorous case study research design.

The gathered data was incorporated into the case study database according to the protocol design. This allowed the researcher to trace the evidence from the source all the way through to the case narrative. Multiple sources of evidence were utilized within the research design and triangulated back to one another to ensure the case study narratives reflected the actual representations given for each of the projects.

Yin states four significant areas that can be accomplished for achieving validity and reliability of a case study. The four tests summarized by Kidder and Judd (1986, pp. 26-29) are given below (Yin, 2009, p. 40):



1. Construct validity: identifying correct operational measures for the concepts being studied.
2. Internal validity (for explanatory or causal studies only and not to descriptive or exploratory studies): seeking to establish a causal relationship, whereby certain conditions are believed to lead to other conditions, as distinguished from spurious relationships.
3. External validity: defining the domain to which a study's findings can be generalized.
4. Reliability: demonstrating that the operations of a study – such as the data collection procedures – can be repeated, with the same results.

To ensure internal validity multiple sources of evidence were used. The information gathered were incorporated into case study databases that linked the narratives with the source data while supporting anonymity of the case reviewers using source codes. The reviewers were given opportunities to review the case narratives and the information was included into the final narratives that are part of the main text. The information sources were presented in bibliography sections within the individual case narratives. The development of the internal validity established the relationships with the data as presented in the case narratives. Themes developed from the data analysis and triangulation of sources helped support the internal validation of the case narratives as accurately capturing the essence of the project management structure. The data collection procedures were documented and presented to ensure replication of analysis. Care was taken to document source data and use triangulation for theme development.

## **APPROPRIATENESS OF THE DATA**

The researcher does not have control over the events that occurred during the project execution and was in a position where the planned events could be attended: meetings, phone calls and weekly meetings. These were unique areas of observation where the dynamics of the project were captured as additional insights into the project management structure. The case study data was used in the formation of evidence that supported developing themes concerning project management structure. The researcher was able to discern the appropriateness of the data and document the associated case study database for analysis. The analysis produced the results of the researcher effort.

## **RELATIONSHIP OF THE DATA TO THE CASE STUDY OBJECTIVE**

The data provided evidence of the project management structure that occurs during the project's life cycle. The objective of the case studies was to provide an accurate depiction of the process and procedures that make up the project management structure from the frame of reference provided by the VSM.

The data consisted of project notes, discussions, meeting minutes, emails, and project artifacts that were generated from the conversations and interactions of the project stakeholders. Categories were developed from the modified Viable Systems Model framework that helped to focus and classify the data. The case study database was developed and used for analysis. The case study database helped develop themes and issues that, when compiled into a narrative form, resulted in the accurate depiction of the cases and the associated context. Individual items within

the case study database that were used as supporting evidence for the themes and issues provided auditability for attributions, and were presented in the case narratives.

## **CASE STUDY DATABASE CONSTRUCTION**

Each evidence item in the cases being studied was assigned a data source code reference so that evidence was recorded while preserving anonymity with respect to source. The code was then corresponded with respect to their relationship to the project. Categories were established to classify items of evidence extracted from the modified VSM analysis.

Evidence items for each category were assigned an evidence item number and recorded. Evidence items were also given a code number that refers to its original data source. An excerpt from the case study database is provided in Appendix 9 which also shows how the source coding was achieved. The major themes and issues from each category in the case study database were extracted and listed in the outline form. The index number of the evidence item that supported each major theme or issue was listed next to it. For the assessing roles related to the data source, a data source code reference was listed next to the major issues each time they were involved in those particular issues. The evidence items or source code citations associated with the theme or issue were used as an indication of the relative importance of the issues used in the decision process. The case study data base was derived from the case study evidence items (which have unique data source codes). The evidence items were used as references for the case narratives as shown in Appendixes 1 and 2.

## **CASE NARRATIVE CONSTRUCTION**

The case study narrative began with an introduction which briefly described the purpose of the study. It also described the process used to analyze the data and draft narrative portion of the case studies by briefly explaining each of the portions of the modified VSM analysis. The narrative then discussed the background and context surrounding the case. This included the overall project history including the feasibility study results.

The narratives described the contextual environment through different perspectives. The roles of the project members and their interactions brought to light elements of the project management systems context and structure. The information flow in and out of the project was described particularly in terms of documented accounts of the project, presentations, and email exchanges between stakeholders. The intermediate inputs and outputs in the form of questions and clarifications were noted. The narrative also discussed the communication and control methods between team members. The project boundary was discussed and any shift in this boundary was also noted.

The case narratives described the roles of the individual project members and the roles they have within the project team. Additional roles of these project members were also noted for clarification as they related to the structure of the project management system. Additionally, the actions of the stakeholders in relationship to the project and project management structure were noted.

The case narratives were accurate depictions of the project management structure of each of the projects under study. The case narrative drafts were provided to the reviewing project members whose comments were incorporated into the final case narrative. The accuracy of these

case narratives was a result of the researcher's ability to correctly interpret the evidence in the case study databases. Multiple sources of evidence and the maintenance of the chain of evidence were used to enhance content validity. The case study narrative procedure is shown in Figure 23 below:

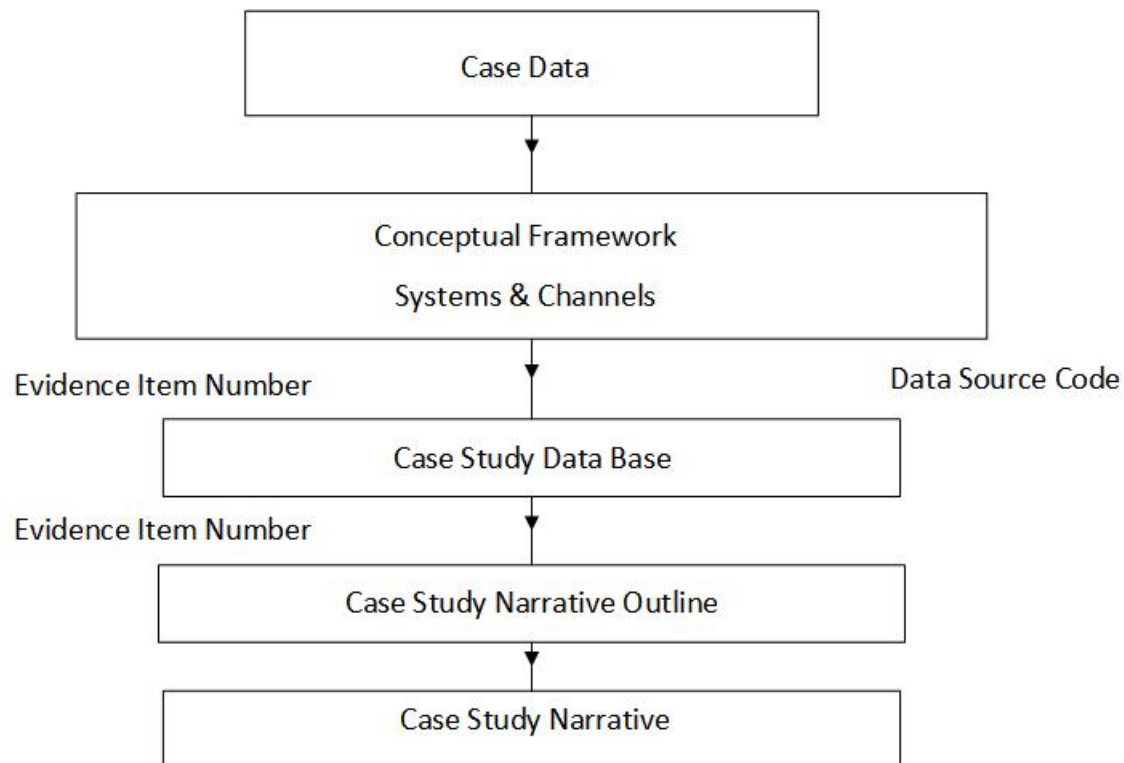

**Figure 23: Case Study Narrative Procedure**

## **CASE VALIDATION AND VERIFICATION**

As a way of validation and verification, the draft copies of the case narratives were provided to selected project members for their review and comment. The selected project

members were based on discussions with the project lead (manager). Criteria for selection included the participation level within the project and willingness to assist in the research. Each selected project stakeholder was given the narratives for their project which included the introduction and the main body, excluding the project history section. Each reviewer was informed that they would be reviewing sections of a larger document and would be included as part of an academia dissertation. The participants were asked to review the narratives for accuracy and make any comments or additions as they would feel would be helpful. The review copies of the case study narratives were returned to the researcher and the researcher revised the case study narratives based on the comments reviewed. These can be seen in Appendices 4 and 5. The validation and verification of data was accomplished by the participant's review of the case narratives.

### **CROSS CASE ANALYSIS**

The cross case analysis was performed by reviewing the two project case studies and comparable sections of the case narratives. This analysis explained the similarities and differences related to the research framework and research questions. The results were analyzed and presented in narrative form in Chapter VIII, Cross Case Analysis, as they related to the research questions. This provided face validation for the case narratives.

### **SUMMARY**

This research design showed how a qualitative analysis of project management structures was accomplished using case study research based on the application of the VSM for purposes of

analysis. The reader was presented with a research design that provides traceability from start to finish for this research effort. The need for case narratives and the importance of the researcher as the instrument for this study was highlighted within this chapter. Additionally, evidence of the required capabilities of the researcher for conducting of this particular design for case study research was identified.

The chapter begins with a design of the research framework. A matrix analysis protocol was established that allowed the systems and channels of the VSM to be compared to each section of the PMBOK as a method of framework comparison. The VSM systems and channels needed to first be defined and identifiers established for this analysis. A ranking system was established for each cross analysis for systems and channels of the PMBOK sections. This allowed a subjective ranking of what system or channel PMBOK was describing in each section. The data was then analyzed to determine the PMBOK's structure with respect to the VSM.

The second part of the chapter described the second Phase of the research effort which was to perform case study research on two projects (meeting specified criteria) which seek to determine face validation of the Phase I results. The chapter describes the protocol used to select the cases, collect the data, the role and skills of the researcher, how the case study was to be used, and the methods for achieving validity and reliability for the results. The chapter ends with the description of the construction of the case narratives, case verification and then a cross case analysis of results. The conclusion and implications following in Chapter IX presented the results of the research effort.

## **FRAMEWORK ANALYSIS FINDINGS**

### **INTRODUCTION**

This section discusses the findings of the PMS analysis using the VSM to view the PMBOK standard PMS structure in a matrix analysis. The matrix analysis findings are presented with an explanation of how the assessment criteria were defined. The section ends with a discussion of the analysis's weaknesses and a section summary.

### **VSM TO PMBOK PMS MATRIX ANALYSIS FINDINGS**

This section looks at the results from performing a matrix analysis using the VSM analysis of PMBOK for insight into project management structures. Additional perspectives for analyzing project management structures can help to provide theoretical results which add to the body of knowledge. The application of the VSM to project management structure has been scarcely developed in the literature. Also, using the case study method as a research design approach offers researchers a rigorous methodology to analyzing project management structures. The case study method has not been dominant in the engineering management or systems engineering fields. A review of the period 1964 to 2016 identified a total of 204,564 thesis or dissertations that use the case study method.

Analysis of the VSM to PMS started with a section by section review of PMBOK taken against the VSM Systems and Channel Identifiers established for this effort. Tabular data showed the characteristics of systems and channels. Each section was ranked 0-3 for content applicability to the VSM as shown below:

'0' - there is not a discernable explicit or implied acknowledgement in the PMBOK for



the identified VSM system or communication channel.

‘1’ - there is not a discernable acknowledgement in the PMBOK for the identified VSM system or communication channel.

‘2’ - there is an implied acknowledgement in the PMBOK for the identified VSM system or communication channel, but not enough to stand on its own.

‘3’ - there is a discernable explicit or implied acknowledgement in the PMBOK for the identified VSM system or communication channel.

Each System and Channel Identifier was summarized for all sections where a subjective determination of whether the PMS identified in PMBOK was associated with the applicable component of the VSM was applicable. The matrix analysis findings were summarized and were then interpreted. An excerpt from the results matrixes is shown below in Table 74:

Project Management Structure	Section	S1	S2	S3	S3*	S4	S5	C1	C2	C3	C4	C5	C6	Alg
Chapter 12	Intro													
	12.1	3	1	3	3	3	3	2	3	3	3	2	3	
	12.2	3	1	3	3	3	3	3	3	3	3	1	3	
	12.3	3	1	3	3	3	3	3	3	3	3	1	3	
	12.4	2	2	2	3	3	2	3	2	3	3	1	3	
3 present		Y		Y	Y	Y	y	Y	Y	Y	Y		Y	
qty of 3		3		3	4	4	3	4	3	4	4		4	
2 present		Y	y	y			y	y	y			y		
qty of 2		1	1	1			1	1	1			1		

**Table 74: Example of VSM to PMBOK PMS Analysis (Chapter 12)**

The summation matrixes show the comparison between VSM and the PMBOK PMS in relation to the number of '3's and '2's assigned to each section. First summed by sections, the chapters with '3' values were then summed for the entire PMBOK document. The summations for sections with '3' and '2' counts are shown below in Table 75:

Chapters ('3' answered)	S1	S2	S3	S3*	S4	S5	C1-Envir	C2-S1s	C3-Corp	C4-Barg	C5-Osc	C6-Audi	Alg
1			1		1	2							
2	3		2	1	2	3	1		3	3			
3						1							
4	2	1	3	2	2	3	1	2	5	5	4	2	
5	3		3	2				3	2	3		2	
6	6		6		5			6	7	4			
7	1		1	1	4			1	1	2	1	1	
8	1		3	3	2			3	1	1		3	
9	4		4	1	4	2		2	4	4	1	1	
10	3		3		2	3		3	3	3			
11	1		2	1	5				1	1		1	
12	3		3	4	4	3	4	3	4	4		4	
13	1		2		3	3	2	4	2	3	3		
Overall Summation	28	1	33	15	34	20	8	27	33	33	9	14	0

Chapters ('2's answered)	S1	S2	S3	S3*	S4	S5	C1-Envir	C2-S1s	C3-Corp	C4-Barg	C5-Osc	C6-Audi	Alg
1		1			3	3	1	1	3	4	3		
2	1		2	2	2		3	4	1	1	3	3	
3	3	1	5	3	6	2	2	2	4	3		4	
4	4	4	3	4	4	3	4	3	1	1	2	4	1
5			2		5	4	4	1	4	3			
6		3	1	1	2	3		1		3	4	5	
7	3	1	3	1		2	1	3	3	2	1	3	
8	2	2			1				2	2	3		
9		4		3	1	2	2	2			1	1	
10		3		3	1		1				3	3	
11	5	1	4	4	1	5		5	5	5		5	
12	1	1	1			1	1	1			1		
13	3		2	1	1		2		1	1	1		
Overall Summation	22	21	23	22	27	25	21	23	24	25	22	28	1

**Table 75: Summation Table for the VSM to PMBOK PMS Analysis Matrix**

All of the tables used for analysis can be found in Appendix 6. Initial indications show when looking at the assigned 3's in the matrix, the Algedonic Channel, System 2 (anti-oscillatory), the C1 environmental channel, and the C5 anti-oscillation channel show a low VSM to PMBOK crossover compared to the other Systems and Channels of the VSM. Looking deeper, where the assigned '2's reflect some VSM to PMBOK crossover, one can see that the weakest area is the Algedonic channel.

The challenges in this analysis include the fact that the analysis required the assignment of ranking of conformance being applied to the VSM to PMBOK PMS analysis. As the replicable process, the delineation of the criteria for assignment of ranking values was designed to increase confidence in attributions made for classification. Consistent ranking during the analysis are needed to ensure accuracy of the data. Being mindful of the ranking and applying it consistently throughout the analysis was instituted to ensure similar results during replicated analysis efforts.

## **SUMMARY**

This section presented the findings of the VSM to PMBOK matrix analysis between the VSM and PMBOK. The Algedonic Channel, System 2 (anti-oscillatory), the C1 environmental channel, and the C5 oscillation channel show a low VSM to PMBOK crossover compared to the other Systems and Channels of the VSM. The results of the matrix analysis findings and the case studies findings are presented in the conclusion and implications chapter, Chapter IX. The results of the analysis provided a framework to guide case study research that applied the framework for analysis of project management structure in a field setting.

## **PROJECT Q: A CASE STUDY**

### **INTRODUCTION**

The purpose of this research was to explore the applicability of the Viable System Model (VSM) as a framework for structural analysis of project management systems using a case study research design. This case study looked at the project management structure of an engineering project group within the government using the modified VSM framework as the analysis framework. The case study showed how the adapted VSM could be used to model a project's system structure and associated communication channels.

### **BACKGROUND**

Today's body of knowledge of complex project-based organizations often focuses on its project management systems and how the organization is structured hierarchically. The Viable System Model (VSM) developed by Stafford Beer was used to analyze an organization from a perspective that differed from the mainstream of the time. The VSM viewed structure not from a hierarchical view but rather the functional interaction of the individual systems and how they interacted iteratively. This study helped bridge the gap between the systems-based analysis of a project based organization and the analysis of its project management structure by using the VSM as an analysis framework for examination of viability. Case study research was used as the rigorous methodology for research.

Case study research is used to enlighten and gain knowledge into complex social phenomena, which can be: a person, group of people, an organization, a social situation, or political phenomena (Yin, 2009). Yin states "the case study method allows investigators to retain

the holistic and meaningful characteristics of real-life events - such as individual life cycles, small group behavior, organizational and managerial process, neighborhood change, school performance, international relations and the maturation of industries” (2009, p. 4). Case study research is a way of researching an empirical topic by following a set of pre-specified procedures while reviewing the logic of design, the data collection methodology, and specifies a unique data analysis approach (Yin, 2009, pp. 18-21). Yin (2009) describes a linear, but iterative process for doing case study research in his book, *Case Study Research: Design and Methods*, 4<sup>th</sup> edition. The guideline goes through the following processes: plan, design, prepare, collect, analyze, and share along with iterations (Yin, 2009).

This research used the exploratory multiple case study as a methodology to study how the Viable System Model (VSM) could be adapted for analysis of the project management structure. The exploratory method was chosen as this is a “contemporary set of events” over which the researcher has little or no control concerning the organizational structure (Yin, 2009, p. 12). This rigorous case study was based on the technical definition of case study research by Yin (Yin, 2009, p. 18). The data was provided by the project leader to ensure all data was vetted through the project lead. Several sources were used during the CSR. The Bibliography of the Data Sources used for this case study and the associated dates the data was received for the event (discussion/observation) was performed are shown in Table 22 below:

Data Source File Number	Name – Description of Data Source	Date Received
0	PQ - [18] T&E WIPT	0518 2016
1	PQ - [18] T&E WIPT Minutes	0518 2016
2	PQ - Weekly SATCOM Meeting	0630 2016
3	PQ - Weekly SATCOM Meeting Minutes	0616 2016
4	PQ - Interview with [11]	0627 2016
5	PQ - Interview with [07]	0627 2016
6	PQ - NCLS Status Matrix	0616 2016
7	PQ - Interview with [18]	0627 2016
8	PQ - Interview with [05]	0628 2016
9	PQ - Interview with [12]	0628 2016
10	PQ - Interview with [17]	0627 2016
11	PQ - Project Financial Documents - Funding	0518 2016
12	PQ - Roles and Responsibilities	0518 2016
13	PQ - PMP	0518 2016
14	PQ - Weekly Activity Report (WAR)	0518 2016
15	PQ - Deliverable Tracking	0518 2016
16	Action Item Tracking	0518 2016
17	Program Management Review (PMR)	0518 2016
18	PQ - Team Communication Example from [00]	0518 2016
19	PQ - Interview with [00]	0707 2016
20	PQ - POAM Example	0518 2016

**Table 22: Excerpt from the Bibliography of the Data Sources**

After selection of the project for the case study, the researcher met with the project lead to get an understanding as to what was expected of the project team. The project lead was informed of the information/ material needed by the researcher for this case study. The researcher advised the project manager that a case study protocol would be used for the data analysis. The need to return and ask further clarifying questions or request further information was discussed. Being a

knowledgeable project manager with a master in engineering management, a bachelor degree in Electrical Engineering, a master's in Engineering Management, the project manager for Project 'Q' was able to attain and gather several documents for review prior to the clarifying discussions with reviewers. The project team members were identified to the researcher. Volunteer members of the team would be consulted on the Project Management System (PMS) of their project. Preliminary questions had been documented and were used for the CSR discussions and proved to be helpful in guiding the discussions and ensured the same basic questions were used throughout the initial phase of the discussion process. The information from the discussions was incorporated into the case study database for later use.

The data from the case study database was analyzed and grouped into theme areas that best matched the elements of the VSM: the Systems and the Channels. The results of the preliminary grouping began to describe the Systems and Channels. The case study data was then analyzed using the matrix analysis approach; the approach used for the VSM to PMBOK PMS structure matrix analysis. Each section was ranked 0-3 for content applicability to the VSM as shown below:

- '0' - there is not a discernable explicit or implied acknowledgement in the PMBOK for the identified VSM system or communication channel.
- '1' - there is not a discernable acknowledgement in the PMBOK for the identified VSM system or communication channel.
- '2' - there is an implied acknowledgement in the PMBOK for the identified VSM system or communication channel, but not enough to stand on its own.
- '3' - there is a discernable explicit or implied acknowledgement in the PMBOK for the



identified VSM system or communication channel.

Evidence items that contained relevance (scored ‘3’) were used in the narrative to support the associated themes; i.e. S1, S2, C1, etc. Table 23 below shows a portion of the tabular data from the matrix analysis of evidence data (from the case study database) with the VSM identifiers (Systems and Channels descriptions) and the associated relevance scores:

Item	Evidence Description	Data Source Code	S1	S2	S3	S3*	S4	S5	C1	C2	C3	C4	C5	C6	Alg
	Contract Lead [02] leading meeting going over the status of tasks that are ongoing.														
1	Presenting it to the rest of the team present with minutes taken by logistics POC [03]	01-00-00-003-05-16-16	0	2	2	1		1		3	1	2	2	1	
2	Some at the table others at their desks in the room	01-00-00-003-05-16-16	3							1					
3	SATCOM Tech 1 [4] inputting to presenter status corrections	01-00-00-003-05-16-16	3	2	1	1		1		2	1	2	2	1	
4	SATCOM Tech 2 [5] inputting to presenter status corrections	01-01-00-003-05-16-16	3	2	1	1		1		2	1	2	2	1	
	Observation some members on cell phone, and computers during the meeting, typically														
5	if not at the table	01-01-00-003-05-16-16	3							1					
	SATCOM Tech 1 [5] point out safety issue on satellite profiles that they need to be														
	aware of and discussed the possible solution (note - I was in a meeting with (4) and														
6	[6] that discussed this concern in an unrelated project mtg/discussion	01-01-00-003-05-16-16	3	2	1	1		2		2	2	2	2	1	
7	How to fix profile assessment discussed by group	01-01-00-003-05-16-16	3	2	2	1	2	1		3	2	3	1	2	
8	Future tasking discussed and added to logistics [1] schedule	01-01-00-003-05-16-16	3	2	1	1	2	2		2	2	2	2	1	
9	Continues to discuss future upcoming events with group	01-01-00-003-05-16-16	3	2	1	1	2	2		2	2	2	2	1	
10	How are scheduling items determined	01-01-00-003-05-16-16	3	2	2	1	2	1		3	2	3	1	2	
	How are updates managed? When government reps say add an item consensus is														
11	discussed and then item is added or modified	01-01-00-003-05-16-16	3	2	2	1	2	1		3	2	3	1	2	
12	Contract [2] continues to follow agenda and leads the meeting	01-01-00-003-05-16-16	3	2	1	1		1		2	1	2	2	1	
13	Logistics [1] asks clarification from [7] on dates and tasks	01-01-00-003-05-16-16	3	2	2	1	2	1		3	2	3	1	2	
14	Discussion on upcoming potential task	01-01-00-003-05-16-16	3	2	1	1	2	2		2	2	2	2	1	
	Discussion of other projects task completion dates as their task depend on the														
	completion of these others. Logistics [2] seemed to have the most knowledge of the														
15	others task schedules	01-01-00-003-05-16-16	3	2	2	1	2	1		3	2	3	1	2	
16	"Who/How is scheduling data provided? By whose direction?"	01-01-00-003-05-16-16	3	2	3	1	2	3	1	3	2	3	2	3	
	Discussion of adding task to long term planning area. Appears to be where task get														
17	added to the list [2] and others	01-01-00-003-05-16-16	3	2	3	1	2	3	1	3	2	3	2	3	
18	[2] speaks up about the issue of profiles and should it be added to the list [4] says yes	01-01-00-003-05-16-16	3	2	1	1	2	2		2	2	2	2	1	
	[2] asks [4] about working on a task. this task is in their area of responsibility. [4] says														
19	effort will be made to make time to support this planned task	01-01-00-003-05-16-16	3	2	1	1	2	2		2	2	2	2	1	
	6.1 rep advises group working on risk management plan. Developing one for the project														
	as per [00]'s boss asked if that was going to be run through [00] first. Didn't appear that														
20	was the initial plan...in progress	01-01-00-003-05-16-16	3	2	1	1	2	2		2	2	2	2	1	
21	[7] mentioned they do risk management with their sponsors on their task	01-01-00-003-05-16-16	3	2	2	2	2	2	1	3	2	2	2	2	
22	Planned absences discussed and documented by [2]	01-01-00-003-05-16-16	3	1	1					2	2	2	2	1	
	[4] mentioned several team membership just recently received an award for something														
23	that occurred over a year ago. Initially didn't even know what it was	01-01-00-003-05-16-16	3	1	1					2	2	2	2	1	
	[5] mentioned how that might have helped their performance rating with their														
24	supervisors had they known about it.	01-01-00-003-05-16-16	3	1	1					2	2	2	2	1	
	BFM not at meeting and was at another meeting as financials were not planned to be														
25	discussed but rather scheduled deliverables as per [00].	01-01-00-003-05-16-16	3	2	2	2	2	2	1	3	2	2	2	2	
26	Document Updates for TEMP	01-00-00-001-05-18-16	3	1	2	1	1	1	1	1	2	2	2	1	1
27	Need for signature routing	01-00-00-001-05-18-16	3	1	2	1	1	1	1	1	2	2	2	1	1
28	Informed sent TEMP to stakeholders	01-00-00-001-05-18-16	3	1	2	1	1	1	1	1	2	2	2	1	1

**Table 23: Evidence Data with Matrix Analysis with Identifiers (Portion)**

Once the case study database evidence items were grouped into themes, the Systems and Channels were drawn into the VSM to better visualize the results for the model of the project's PMS. The tabular information best describes the elements that form the Systems and Channels specific to the project in focus, as the diagram is nearly identical to the proposed VSM model. An example of how System One themes were identified from the data is shown below in Table 24:

System	Definition(s)	Identifiers
S1	<p>Elements concerned with performing the key transformations of the organization; produces the products. (Beer, 1981)</p> <p>The autonomous unit that produces the product or service. (Beer, 1981)</p>	<p>Produces the product or service; only system that is autonomous/viable buy itself. (Beer, 1981)</p> <p>Operates autonomously within agreed parameters. (Keating, et al, 2012)</p> <p>Produce systems product and services to agreed-upon standards and performance levels within the allocated resources. (Keating, et al, 2012)</p> <p>Interface with S2 for coordination within the larger systems. (Keating, et al, 2012)</p> <p>Provide direct interface to the local system environment. (Keating, et al, 2012)</p>

**Table 24: S1 System Description**

Table 24 shows how the System One Identifier information from the VSM model was matched with the data from the case study database. The Systems and Channel information formed the basis of the narrative themes. The triangulation of evidence data in the case study database with the identifier information for systems and channels for the VSM are how the project's VSM model was developed. The matrix analysis was performed for each System and Channel themes

within the case study database evidence entries. The data was used to form the case narrative and final adapted VSM model for the project. The linkage back to the source data was maintained throughout the analysis.

The basic VSM model as a template is shown below in Figure 24. This template is the starting point for which case study data would be added to. Consistent with the research database design, the researcher first identified the Systems and followed with the identification of the primary six Communication Channels. Each system and channel was described individually to better highlight the relationship with the case study database evidence items. The individual components of the model were then combined into the Project 'Q' VSM at the conclusion of the case narratives.

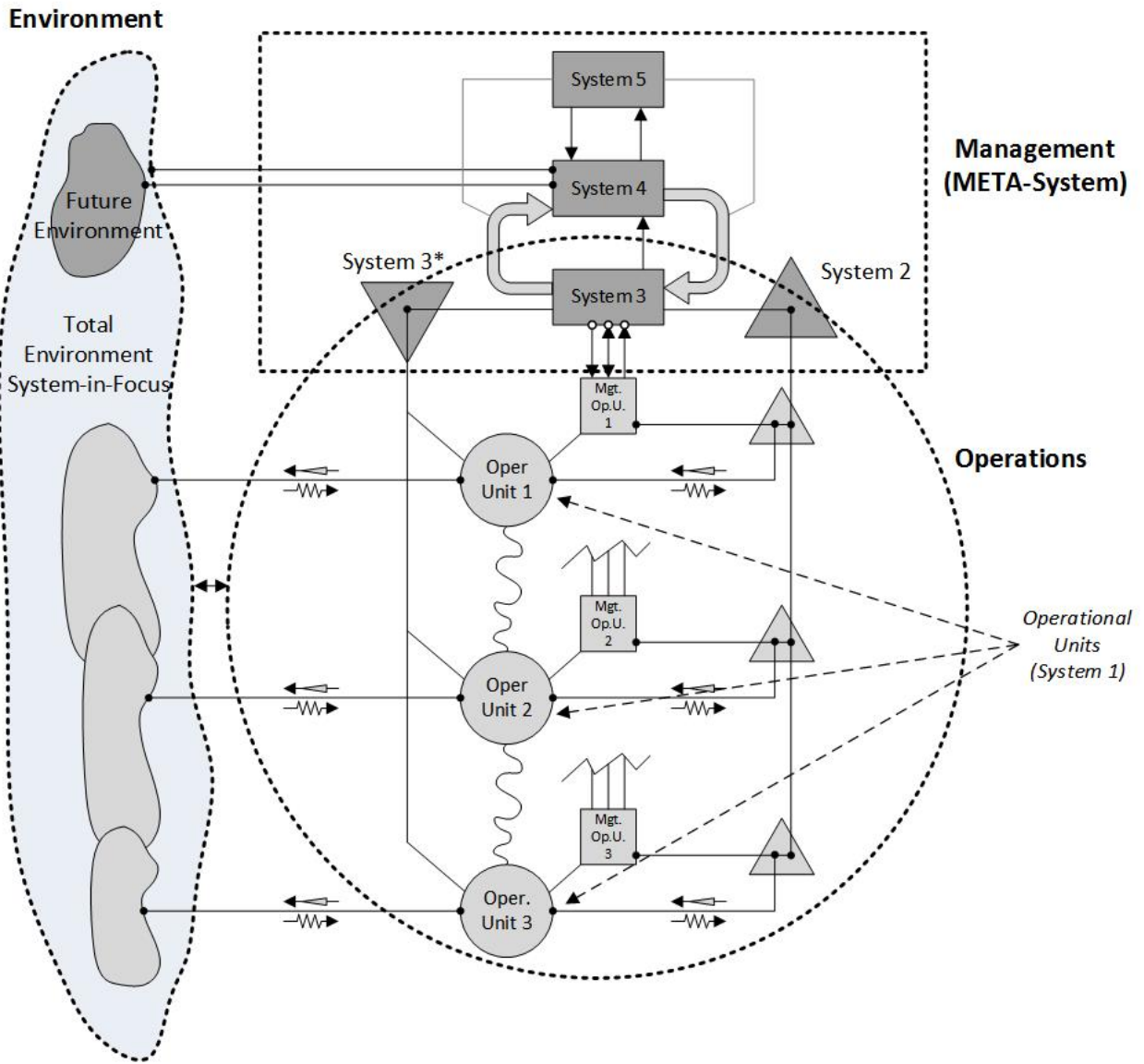

**Figure 24: Preliminary VSM Diagram for a Project**

## **SYSTEM ONE DEVELOPMENT FROM THE CSR DATABASE**

The primary System One functions of this project were the tasking that the sponsor had funded and passed on to the project team in the form of the task planning letters and associated funding documents. The tasks descriptions are summarized for Project 'Q' as shown below:

1. Government oversight of the project.
2. Fleet Engineering Support.
3. System Engineering Management.
4. Acquisition Management.
5. Financial Management.
6. Integrate, Assembly, & Test Production.
7. Removal of four (4) unit level variant (Refers to an equipment suite – the unit level variant being the basic level unit of the installed equipment system).

The tasks were combined at the project level based on how the project lead engaged. The tasking associated with the project, the System One's of this project model, became the following (modeled for Project 'Q'):

1. Government Oversight/Acquisition/Financial Management of Project 'Q'.
2. Fleet Engineering Support.
3. System Engineering Management.
4. Integrate, Assembly, Test (Install/Remove) and Production Support.

The System One contained the scheduling data for the tasks and identified resources were scheduled and defined in S1. Definition of the tasks of the task leaders was described. System One definitions and identifiers are shown below in Table 25:

System	Definition(s)	Identifiers
S1	<p>Elements concerned with performing the key transformations of the organization; produces the products. (Beer, 1981)</p> <p>The autonomous unit that produces the product or service. (Beer, 1981)</p>	<p>Produces the product or service; only system that is autonomous/viable buy itself. (Beer, 1981).</p> <p>Operates autonomously within agreed parameters. (Keating, et al, 2012).</p> <p>Produce systems product and services to agreed-upon standards and performance levels within the allocated resources. (Keating, et al, 2012).</p> <p>Interface with S2 for coordination within the larger systems. (Keating, et al, 2012).</p> <p>Provide direct interface to the local system environment. (Keating, et al, 2012).</p>

**Table 25: S1 Definition/Identifiers**

The System One definitions and identifiers from Table 25 above were used in a matrix analysis of evidence items within the CSR database. The evidence items that support the findings of a System One in the project are shown below in Table 26 below:

Evidence Items	Evidence #'s
SATCOM Tech 1 [4] inputting to presenter status corrections.	3
SATCOM Tech 2 [5] inputting to presenter status corrections.	4
Observation some members on cell phone, and computers during the meeting, typically if not at the table.	5
SATCOM Tech 1 [5] point out safety issue on satellite profiles that they need to be aware of and discussed the possible solution (note - I was in a meeting with {4} and {6} that discussed this concern in an unrelated project meeting/discussion.	6
How to fix profile assessment discussed by group.	7
Future tasking discussed and added to logistics [1] schedule.	8
Continues to discuss future upcoming events with group.	9
How are scheduling items determined?	10
How are updates managed? When government reps say add an item consensus is discussed and then item is added or modified.	11
Contract [2] continues to follow agenda and leads the meeting.	12
Logistics [1] asks clarification from [7] on dates and tasks.	13
Discussion on upcoming potential task.	14
Discussion of other projects task completion dates as their task depend on the completion of these others. Logistics [2] seemed to have the most knowledge of the others task schedules.	15
"Who/How is scheduling data provided? By whose direction?"	16
Discussion of adding task to long term planning area. Appears to be where task get added to the list [2] and others.	17
[2] Speaks up about the issue of profiles and should it be added to the list [4] says yes.	18

**Table 26: Evidence Items for S1**

The Case Study Database actually shows more items that support S1 than what Table 26 shows.

Table 26 shows 16 items for convenience; i.e. overwhelming evidence shows S1 exists in this project.

## SYSTEM TWO DEVELOPMENT FROM THE CSR DATABASE

The System Two can best be described as the working relationship between the individual tasks leads and the interaction within the project lead. The System Two contained the anti-oscillatory action between the S1s. Definition of the tasks of the task leaders was described. S2 definitions and identifiers are shown below in Table 27:

System	Definition(s)	Identifiers
S2	<p>Anti-oscillatory regulatory, input filter to S3. (Beer, 1981)</p> <p>Divisional/Corporate regulatory. (Beer, 1981, p. 157)</p> <p>Metasystem subsuming all S1's. (Beer, p. 172, 1981)</p>	<p>Coordinator, preventing oscillations. (Beer, 1981 , p. 160)</p> <p>Elaborate interface between S1 and S2. (Beer, 1981)</p> <p>Monitors what S1 does. (Beer, 1981)</p> <p>Input filter to S3. (Beer, 1981)</p> <p>Services S1 and is not a command channel. (Beer, 1979)</p> <p>Not routine services, but anti-oscillatory. (Beer, 1979)</p> <p>Must be recognized by the observer. (Beer, 1979, p. 189)</p> <p>"To avoid explosion is minimally to constrain freedom". (Beer, 1979, p. 190)</p> <p>Maintain coordination among S1's. (Keating, et al, 2012)</p> <p>Promote system efficiency amongst S1s. (Keating, et al, 2012)</p> <p>Identify and manage emergent conflict between S1s. (Keating, et al, 2012).</p> <p>Identify system integration issues for system level resolution. (Keating, et al, 2012)</p>

**Table 27: S2 Definitions/ Identifiers**



The System Two definitions and identifiers from Table 27 above were used in a matrix analysis of evidence items within the CSR database. The evidence items that support the findings of a System Two in the project are shown below in Table 28:

Item	Evidence Description	Data Source Code	S2
6	SATCOM Tech 1 [5] point out safety issue on satellite profiles that they need to be aware of and discussed the possible solution (note - I was in a meeting with {4} and {6} that discussed this concern in an unrelated project mtg/discussion	01-01-00-003-05-16-16	3
7	How to fix profile assessment discussed by group	01-01-00-003-05-16-16	3
8	Future tasking discussed and added to logistics [1] schedule	01-01-00-003-05-16-16	3
9	Continues to discuss future upcoming events with group	01-01-00-003-05-16-16	3
10	How are scheduling items determined	01-01-00-003-05-16-16	3
11	How are updates managed? When government reps say add an item consensus is discussed and then item is added or modified	01-01-00-003-05-16-16	3

**Table 28: S2 Case Study Evidence Items (Portion)**

This anti-oscillatory interaction usually occurred at the weekly project meetings, at a PMR (Project Management Review), or through email discussions. The function of System Two was to prevent oscillation between the System One's with respect to resources and other needs. The project lead sent an aggregated task proposal/estimate to the sponsor. The sponsor worked with the project lead to accept and approve the estimate intended to be funded. The agreement of this interaction was accomplished when the sponsor sent the task planning letters and acceptance of this tasking letter by the project and organization was confirmed. The funding document was the actual dollars sent to the project for utilization. As the project team broke down the project into identifiable tasks, from the now aggregated estimate which was modified by the sponsor, the government tasks leads used their previous estimates to baseline schedules, funding allocations,

contract support, etc. The project lead accepts the tasking and determined tasking to be in accordance with funding. The discussions on funding differences were typically between the task lead and the project lead along with the Business Financial Manager (BFM) (others were included both for learning and to be informed). If the problem was not resolved between the S1's at the S3 level, the problem would have risen up to the S5 level for resolution.

The individual System One's had both government and contract support team members. Some task leads combined their contractor and material procurement needs into a single combined contract to save dollars and management costs. Some oscillation occurred when, for example, the contractor began to spend more than was allocated for their task on the single contract. Early detection and monitoring of the situation reduced the oscillation and prevented further problems with this type of funding expenditures discrepancy.

### **SYSTEM THREE AND THREE\* (STAR) DEVELOPMENT**

The System Three functionally was comprised of the task leads, the project lead, the BFM, and contractor team lead. This functional role was exercised during weekly meetings, government oversight functions, and contract negotiations. The "here-and-now" (Beer, 1981) of the current tasking and associated schedules were discussed. Resources were identified, tracked, and reported during these System Three level meetings and the information was then processed for distribution amongst the task leads and their team members, usually sent via email.

The System Three and Three\* (Star) contained the first level management of the project and also the monitoring and control functions for the project. Definition of the S3 and S3\* (Star)

tasks were described earlier in the document and are shown below in Tables 29 and Table 30 respectively:

System	Definition(s)	Identifiers
S3	<p>Provides interface with S4 and S5 structures and controls that establish rules, resources, rights, and responsibilities of S1. (Beer, 1982)</p> <p>Operative management. (Ríos, 2012)</p> <p>Highest level of autonomic management. (Beer, 1981, pp. 175-176)</p> <p>Lowest level of corporate management. (Beer, 1981)</p> <p>Govern the stability of the internal environments of the project. (Beer, 1981)</p> <p>Transmitter of policy/special instructions to the divisions. (Beer, 1981)</p> <p>Tracer of information of internal environment: metasystem controller downward, senior filter of information upward. (Ríos, 2012)</p> <p>Handles S2 information circuits. (Beer, 1981)</p>	<p>Highest level of autonomic magnet and the lowest level of corporate management of the systems in focus. (Beer, p. 175, 1981).</p> <p>Transmitter of policy and special instructions to the divisions/S1s. (Beer, 1981, p. 176)</p> <p>Recover of information of the internal environment; sends information upwards and downwards; only recovery of information upward from S2. (Beer, 1981, p. 176)</p> <p>Aware of what's going on inside the firm now. (Ríos, 2012)</p> <p>Manage the 'here and now' of the organization. (Ríos, 2012)</p> <p>Describing the channels between S4 and S3. (Ríos, 2012)</p> <p>Facilities resources communications between representatives form S3 and S4. (Ríos, 2012)</p> <p>Methodological and functional communications trough models and tools. (Ríos, 2012).</p> <p>Setting goals. (Ríos, 2012)</p> <p>Negotiating resources. (Ríos, 2012)</p> <p>Accountability procedures. (Ríos, 2012)</p> <p>Marketing's, sales, human resources, productivity and quality, production and operation, engineering, accounting, budgeting (Ríos, 2012).</p> <p>Handles divisional interactions. (Beer, 1981)</p> <p>This is where the financial director, a production director, and as sale director would operate. "Each of them is setting out to integrate the work foot he respective divisional managers". (Beer, 1979, p. 202)</p> <p>Operational planning and control for ongoing system performance. (Keating, et al, 2012)</p> <p>Interprets and implements policies from S5, Interfaces with S4 to redesign operation in response and identification of environmental changes. (Keating, et al, 2012)</p>

**Table 29: S3 Definition/Identifiers**

The S3 definitions and identifiers from Table 29 above were used in a matrix analysis of evidence items within the CSR database. The evidence items that support the findings of a S3 in the project are shown below in Table 30 below:

System	Definition(s)	Identifiers
S3*	Audit channel. (Beer, 1981)	<p>Highest level of autonomic magnet and the lowest level of corporate management of the systems in focus. (Beer, 1981, p. 175)</p> <p>Transmitter of policy and special instructions to the divisions/S1s. (Beer,1981, p. 176)</p> <p>Recover of information of the internal environment; sends information upwards and downwards; only recovery of information upward from S2. (Beer, 1981, p. 176)</p> <p>Monitor Subsystems and system level performance. (Keating, et al, 2012)</p> <p>Identify and analyze deviant performance, unexpected crisis, and operational conditions and trends. ( Keating, et al, 2012)</p>

**Table 30: S3\* (Star) Definitions/Identifiers**

Item	Evidence Description	Data Source Code	S3
9	Continues to discuss future upcoming events with group	01-01-00-003-05-16-16	3
10	How are scheduling items determined	01-01-00-003-05-16-16	3
11	How are updates managed? When government reps say add an item consensus is discussed and then item is added or modified	01-01-00-003-05-16-16	3
12	Contract [2] continues to follow agenda and leads the meeting	01-01-00-003-05-16-16	3
13	Logistics [1] asks clarification from [7] on dates and tasks	01-01-00-003-05-16-16	3
14	Discussion on upcoming potential task	01-01-00-003-05-16-16	3

**Table 31: S3 Evidence Item Descriptions (Portions)**

The S3\* (Star) definitions and identifiers from Table 31 above were used in a matrix analysis of evidence items within the CSR database. The evidence items that support the findings of a S3\* (Star) in the project are shown below in Table 32:

Item	Evidence Description	Data Source Code	S3*
15	Discussion of other projects task completion dates as their task depend on the completion of these others. Logistics [2] seemed to have the most knowledge of the others task schedules	01-01-00-003-05-16-16	3
16	"Who/How is scheduling data provided? By whose direction?"	01-01-00-003-05-16-16	3
17	Discussion of adding task to long term planning area. Appears to be where task get added to the list [2] and others	01-01-00-003-05-16-16	3
18	[2] speaks up about the issue of profiles and should it be added to the list [4] says yes	01-01-00-003-05-16-16	3
19	[2] asks [4] about working on a task .this task is in their area of responsibility. [4] says] effort will be made to make time to support this planned task.	01-01-00-003-05-16-16	3
20	6.1 rep advises group working on risk management plan. Developing one for the project as per [00]'s boss asked if that was going to be run through [00] first. Didn't appear that was the initial plan...in progress	01-01-00-003-05-16-16	3
21	[7] mentioned they do risk management with their sponsors on their task	01-01-00-003-05-16-16	3

**Table 32: S3\* (Star) Evidence Items (Portion)**

System Three provided the reports based on templates provided by the project lead. System Three\* (Star) were from internal audits and PMRs. The internal audits were initiated by organizational policy and procedure reviews which looked to the project leads to provide artifacts for their defense. The PMR initiated by the program sponsors were an effort to ensure tasking was being performed as agreed upon in the task planning letters. Project leads also performed unscheduled visits to the work areas to monitor project activities. Similar requests for statuses that were not routine were identified in emails from the project lead to the team members.

## **SYSTEM FOUR DEVELOPMENT FROM THE CSR DATABASE**

The System Four was the most difficult to identify. In talking with the team members, most felt they got their strategic views from the program office/sponsor. This was reflected in the weak identity the group had as project team within this organization. The project team itself was part of a multi-organizational project team that the sponsor tasked. The tasking was the same. Within a competency aligned organization the project team, based on competency assignments, are members of a competency as well that provided human resources to the projects. In talking with the project lead, the strategic planning went beyond the future phase and into conversations with vendors and other organizational members. Task leads discussed future planned efforts formally but strategic tasking was more of an informal process at this time. The project lead and task leads merged the task of developing a model of the status of the projects to be passed up to management and associated customers/stakeholders that warranted the reporting. The discussion that did occur occurred between the project lead and task leaders (and any potential stakeholders) were at best referred to as brainstorming. The System Four contained the forward looking area of the project. Definition of the tasks of the S4 system was described earlier in this document. System Four definitions and identifiers are shown below in Table 33:

System	Definition(s)	Identifiers
S4	<p>Development directorate of the organization. (Beer, 1981, p. 181)</p> <p>Detecting and conveying changes and needs determined by the evolution of the environment and conveying this to the interior organization. (Ríos, 2012)</p> <p>Strategic management. (Ríos, 2012)</p> <p>Elements which look outward to the environment to understand how the organization needs to adapt to remain viable. (Beer, 1981)</p> <p>The model S4 use helps to facilitate the examination of corporate plans on the indefinite time-base which invalidates so many static models of the corporate economy. (Keating, et al, 2012)</p>	<p>A description of management and individual's purpose is S4. (Ríos, 2012)</p> <p>Explicit descriptions of activities that each individual does for S4. (Ríos, 2012)</p> <p>Means that organization supports S4 efforts. (Ríos, 2012)</p> <p>Simulation models, tools for carrying out prospective studies, methods employed to explore alternative decisions, decision area. (Ríos, 2012)</p> <p>Elements or physical visualizations of past/present/modeled data for decision making. (Ríos, 2012)</p> <p>Environment areas to account for include: commercial, social, demographic, technological, political, legal, economic, ecological, and educational. (Ríos, 2012)</p> <p>Sensor, transducers channels of communications analysis of how to make these work. (Ríos, 2012)</p> <p>Awareness of how data/information is captured viewed/presented and associated characteristics. (Ríos, 2012)</p> <p>Review of vision, mission, objectives, business model, profitable growth areas, new challenges, and chances for transformation as desired, expansions, etc. (Ríos, 2012)</p> <p>Information switch between S3/S5 filtered. (Beer, 1981)</p> <p>Foster strategic learning, development, and transformation. (Keating, et al, 2012)</p> <p>Maintain environmental scanning, analysis, and interpretation. (Keating, et al, 2012)</p> <p>Maintain models of the systems for other subsystems and the environment; guides system transformation; identify system trends and patterns. (Keating, et al, 2012)</p>

**Table 33: S4 Definition/Identifiers**

The S4 definitions and identifiers from Table 33 above were used in a matrix analysis of evidence items within the CSR database. The evidence items that support the findings of a S4 in the project are shown below in Table 34 below:

Item	Evidence Description	Data Source Code	S4
11	How are updates managed? When government reps say add an item consensus is discussed and then item is added or modified	01-01-00-003-05-16-16	3
12	Contract [2] continues to follow agenda and leads the meeting	01-01-00-003-05-16-16	3
13	Logistics [1] asks clarification from [7] on dates and tasks	01-01-00-003-05-16-16	3
14	Discussion on upcoming potential task	01-01-00-003-05-16-16	3
15	Discussion of other projects task completion dates as their task depend on the completion of these others. Logistics [2] seemed to have the most knowledge of the others task schedules	01-01-00-003-05-16-16	3
16	"Who/How is scheduling data provided? By whose direction?"	01-01-00-003-05-16-16	3
17	Discussion of adding task to long term planning area. Appears to be where task get added to the list [2] and others	01-01-00-003-05-16-16	3

**Table 34: S4 Evidence Items (Portion)**

## SYSTEM FIVE DEVELOPMENT FROM THE CSR DATABASE

The System Five identity of the project centered on the project lead and the BFM which had final negotiating authority over the tasking the project accepted. The sponsor informally dictated the name of the project based on the way estimates were routed up through the government channels for approval and provided the source of funding. The reverse path was similar but was not exactly the same based on the requirements and priorities determined at each level of appropriation. The funding document was the determining factor as to what the project was: the funding document matched requirements to funded tasking. The project lead maintained the final decision authority for project related decisions within the organization and also was responsible for all the processes, data calls, and organizational procedures to be followed. The project was autonomous, but not purely. Organizational management requirements occurred and needed to be passed down appropriately to the team. The System Five contained the project's identify and final decision point. Definition of the S5 tasks was described earlier in the dissertation. System Five definitions and identifiers are shown below in Table 35:



System	Definition(s)	Identifiers
S5	<p>Responsible for policy and decisions. (Beer, 1981)  "Collegiate authority".  (Beer, 1981, p. 154)  Provides the identity of the organization. (Beer, 1981)  Responsible for achieving equilibrium between the present functioning of the organization and its preparation for the future. (Ríos, 2012)  Creates policy decisions within the organization as a whole to balance demands from different organizations and provide direction to the organizational s a whole. (Beer, 1982)  Normative management. (Ríos, 2012)</p>	<p>Looks at needs of divisions and may sacrifice resources for the greater good. (Beer, 1981, p. 160)  Operations room environment available. (Beer, 1981)(Ríos, 2012)  Provides Identity of the organization. (Beer, 1981)  Resources that actually make up S5 identified. (Ríos, 2012)  Procedures to communicate strategic plan/identity to the organization. (Ríos, 2012)  Are channels in place to communicate S5 needs, sensors, emergency access to S5; i.e. functional. (Ríos, 2012)  Interaction between S3/S4 with S5 to maintain equilibrium/resolve S3/S4 issues. (Ríos, 2012).  Develop system policy and direction. (Keating, et al, 2012).  Strategic goals/objectives written. (Ríos, 2012)  Monitors vertical command axis for obeying instructions. (Beer, 1981, p. 159)  Formal declaration of vision, mission, purpose. (Ríos, 2012)  Represent and communicate the system to external entities; process input/outputs forms other subsystems; establish system policy and strategic direction. (Keating, et al, 2012)  Propagate system identity; maintain and propagate mission/vision/identity. (Keating, et al, 2012)  Balance systems focus between S3 and S4 (now and future). (Keating et al, 2012)</p>

**Table 35: S5 Definition/Identifiers**

The S5 definitions and identifiers from Table 35 above were used in a matrix analysis of evidence items within the CSR database. The evidence items that support the findings of a S5 in the project are shown below in Table 36 below:

<b>Item</b>	<b>Evidence Description</b>	<b>Data Source Code</b>	<b>S5</b>
7	How to fix profile assessment discussed by group	01-01-00-003-05-16-16	3
8	Future tasking discussed and added to logistics [1] schedule	01-01-00-003-05-16-16	3
9	Continues to discuss future upcoming events with group	01-01-00-003-05-16-16	3
10	How are scheduling items determined	01-01-00-003-05-16-16	3
11	How are updates managed? When government reps say add an item consensus is discussed and then item is added or modified	01-01-00-003-05-16-16	3
12	Contract [2] continues to follow agenda and leads the meeting	01-01-00-003-05-16-16	3
13	Logistics [1] asks clarification from [7] on dates and tasks	01-01-00-003-05-16-16	3
14	Discussion on upcoming potential task	01-01-00-003-05-16-16	3

**Table 36: S5 Evidence Items (Portion)**

## **CHANNEL DEVELOPMENT FROM THE CSR DATABASE**

The next phase dealt with modeling the communication channels of the project to the VSM. The communication channels in the VSM are the elements that connect both the diverse functions specified in the VSM and the organization with its environment(s) (Ríos, 2012). The channels provide the equilibrium, balance or homeostasis of the internal environment of the system in view. The six primary channels of the VSM can be characterized as follows (Ríos, 2012, p. 61):

1. Channel One – C1 – Channel connecting and absorbing variety between the environments of each elementary operational unit.
2. Channel Two – C2 – Channel connecting the various elemental operations (operational units making up System One).
3. Channel Three – C3 – Corporate intervention channel (System Three-System One).
4. Channel Four – C4 – Resources bargaining channel (System Three – System One).
5. Channel Five – C5 – Anti-oscillatory channels (Co-ordination) (System Two).
6. Channel Six – C6 – Monitor channel (Auditor).

- 7. Algedonic Channel – Transmits alert signal concerning any event or circumstance that could jeopardize the organization. Travels straight to the top through existing links.

The six primary VSM communication channels can be seen in Figure 25 below:

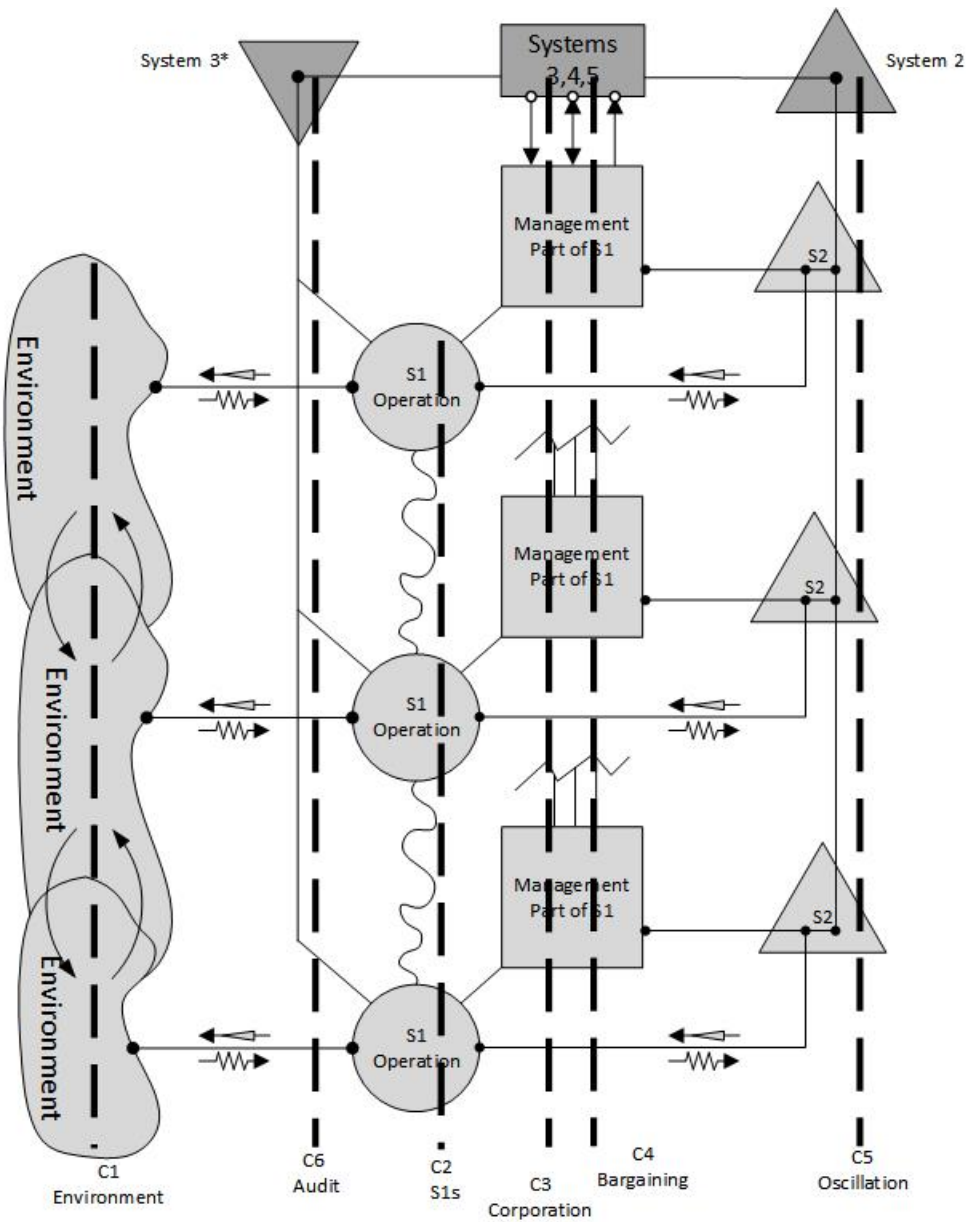

**Figure 25: The Six Primary Communication Channels of the VSM**

The case study database and the available artifacts provided were examined to develop and validate the use of the six primary channels of the VSM. The project lead provided a communications diagram of how the project was supposed to communicate. This diagram was discussed at the higher level project team meetings that consisted of this project team and another along with the overall project sponsor. The project lead provided and discussed with the project team separately. The communication diagram is shown in Figure 26 below:

E#18

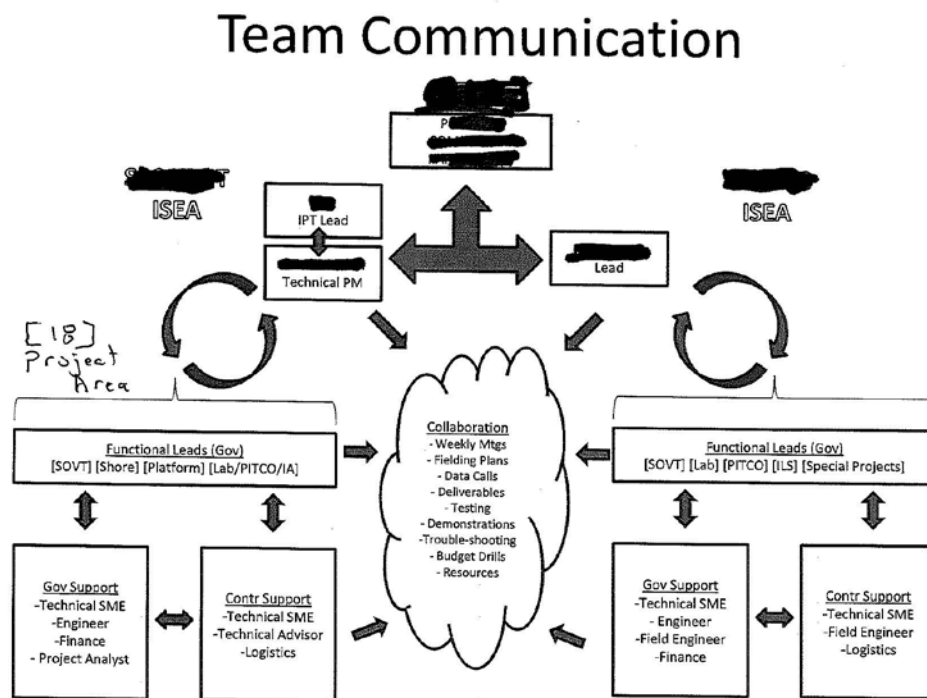

**Figure 26: Evidence #18 Team Communication Examples**

The channel development used the communication channel definitions and identifiers used earlier in the document. The analysis of the evidence items were performed similarly to the Systems development and used to identify the model's communication channels. The next sections summarize the linkage between Definition/Identifiers to the case study database evidence items.

### **CHANNEL ONE DEVELOPMENT FROM THE CSR DATABASE**

Analyzing for elements of Channel One, the researcher looked for communication channels connecting and absorbing variety between the environments of each elementary operational unit. An example of this was found where the same contractor received tasking from two different task leads with specific product/service output requirements. The task leads from the S1 work with the same contractor team to get their tasks completed. The purchase of material for two different tasks from the same vendor is another example of this communication between the environmental units to members of the project team. Channel evidence to support the existence of C1 is shown below in Table 37:

<b>Item</b>	<b>Evidence Description</b>	<b>Data Source Code</b>	<b>C1</b>
3	SATCOM Tech 1 [4] inputting to presenter status corrections	01-00-00-003-05-16-16	3
4	SATCOM Tech 2 [5] inputting to presenter status corrections	01-01-00-003-05-16-16	3
25	BFM not at meeting and was at another meeting as financials were not planned to be discussed but rather scheduled deliverables as per [00].	01-01-00-003-05-16-16	3
26	Document Updates for TEMP	01-00-00-001-05-18-16	3

**Table 37: C1 Evidence Items (Portion)**

## CHANNEL TWO DEVELOPMENT FROM THE CSR DATABASE

Analyzing for elements of Channel Two, the researcher looked for Communications Channel connecting the various operational (S1s) units. Communications between the S1's usually occurred at the weekly meetings. Minutes were generated and distributed. Each of the weekly meeting examined current resources used and planned resources that were used for the different tasks were discussed. When the task leads and members of the team were going to be out either on travel, leave, etc. was also discussed, giving all the project team insight to everyone's whereabouts. BFM and contractor provided financial data was reviewed to ensure work progress as expected along with expenditures. Channel evidence to support the existence of C2 is shown below in Table 38:

Item	Evidence Description	Data Source Code	C2
2	Some at the table others at their desks in the room	01-00-00-003-05-16-16	3
3	SATCOM Tech 1 [4] inputting to presenter status corrections	01-00-00-003-05-16-16	3
26	Document Updates for TEMP	01-00-00-001-05-18-16	3
27	Need for signature routing	01-00-00-001-05-18-16	3
48	Meeting minutes, attendees, organization, POC information	00-00-00-002-05-03-16	3
49	Roll call and agenda presented	00-00-00-002-05-03-16	3
50	Temp Status presented	00-00-00-002-05-03-16	3
51	WIPT Charter Status presented	00-00-00-002-05-03-16	3
59	[18] project is made up of two elements MSC & FMP and maybe three SCN	01-11-02-004-06-27-16	3
60	{ 12 } and [5] are the CBSP team Ron works with	01-11-02-004-06-27-16	3
61	Tasking letter from PMW 170 is their guidance	01-11-02-004-06-27-16	3
62	Sponsor guidance by N6 Manager at Sponsor financial shop	01-11-02-004-06-27-16	3

**Table 38: C2 Evidence Item (Portion)**

### CHANNEL THREE DEVELOPMENT FROM THE CSR DATABASE

Analyzing for elements of Channel Three, the researcher looked for communication primarily between the S3 and S1's which provided project updates and examined the communications which helped define the management style used within this channel. The task leads had discussions concerning their task at the weekly meetings whose minutes were recorded and distributed. The task leads had group meetings with their team and daily working discussions that helped capture the data for reporting. The weekly meeting format was used to brief all of the project team members. At times the discussions of an ongoing task were discussed with the sponsor and the task lead (and its team). The results were filtered to the project lead for submission up to the S3 (primarily the project lead and BFM). The S3 provided the task leads insight into the organization culture and decision making ongoing within the support areas of the organization; for example, contracts areas, management's project priorities, submission deadlines, training opportunities, etc. Channel evidence to support the existence of C3 is shown below in Table 39:

Item	Evidence Description	Data Source Code	C3
2	Some at the table others at their desks in the room	01-00-00-003-05-16-16	3
3	SATCOM Tech 1 [4] inputting to presenter status corrections	01-00-00-003-05-16-16	3
18	[2] speaks up about the issue of profiles and should it be added to the list [4] says yes	01-01-00-003-05-16-16	3
19	[2] asks [4] about working on a task .this task is in their area of responsibility. [4] says] effort will be made to make time to support this planned task.	01-01-00-003-05-16-16	3
20	6.1 rep advises group working on risk management plan. Developing one for the project as per [00]'s boss asked if that was going to be run through [00] first. Didn't appear that was the initial plan...in progress	01-01-00-003-05-16-16	3
21	[7] mentioned they do risk management with their sponsors on their task	01-01-00-003-05-16-16	3
22	Planned absences discussed and documented by [2]	01-01-00-003-05-16-16	3
23	[4] mentioned several team membership just recently received an award for something that occurred over a year ago. Initially didn't even know what it was.	01-01-00-003-05-16-16	3

**Table 39: C3 Evidence Items (Portion)**

## CHANNEL FOUR DEVELOPMENT FROM THE CSR DATABASE

Analyzing for elements of Channel Four, the researcher looked for areas where resource bargaining occurred between the S1's and S3's. With changes in schedule frequent, the need for resources and the availability of resources changed during project execution. The task leaders were able to solidify prior arrangements or discussed current options for shifting resources and adjusting schedules amongst themselves; ensuring their efforts didn't affect overall project baselines. Channel evidence to support the existence of C4 is shown below in Table 40:

Item	Evidence Description	Data Source Code	C4
18	[2] speaks up about the issue of profiles and should it be added to the list [4] says yes	01-01-00-003-05-16-16	3
19	[2] asks [4] about working on a task .this task is in their area of responsibility. [4] says] effort will be made to make time to support this planned task.	01-01-00-003-05-16-16	3
25	BFM not at meeting and was at another meeting as financials were not planned to be discussed but rather scheduled deliverables as per [00].	01-01-00-003-05-16-16	3
26	Document Updates for TEMP	01-00-00-001-05-18-16	3
46	Overview drawing of system presented	01-00-00-001-05-18-16	3
47	closed action items presented	01-00-00-001-05-18-16	3
48	Meeting minutes, attendees, organization, POC information	00-00-00-002-05-03-16	3
49	Roll call and agenda presented	00-00-00-002-05-03-16	3
59	[18] project is made up of two elements MSC & FMP and maybe three SCN	01-11-02-004-06-27-16	3
60	{ 12} and [5] are the CBSP team works with	01-11-02-004-06-27-16	3

**Table 40: C4 Evidence Item (Portion)**

## CHANNEL FIVE DEVELOPMENT FROM THE CSR DATABASE

Analyzing for elements of Channel Five, the researcher looked for areas where S2's functional areas were working to reduce conflicts and other project level oscillations. The presentation of schedules and baselines helped to ensure all the task members were aware of



where the resources were initially planned. Conflicts or changes that affected another task were often brought up early and mitigated whether through email or during the meetings. Not all conflicts had time to be worked out prior to weekly meetings and the resolutions to those conflicts were recorded in the weekly meetings and distributed. Channel evidence to support the existence of C5 is shown below in Table 41:

Item	Evidence Description	Data Source Code	C5
2	Some at the table others at their desks in the room	01-00-00-003-05-16-16	3
3	SATCOM Tech 1 [4] inputting to presenter status corrections	01-00-00-003-05-16-16	3
4	SATCOM Tech 2 [5] inputting to presenter status corrections	01-01-00-003-05-16-16	3
5	Observation some members on cell phone, and computers during the meeting, typically if not at the table	01-01-00-003-05-16-16	3
15	Discussion of other projects task completion dates as their task depend on the completion of these others. Logistics [2] seemed to have the most knowledge of the others task schedules	01-01-00-003-05-16-16	3
16	"Who/How is scheduling data provided? By whose direction?"	01-01-00-003-05-16-16	3
17	Discussion of adding task to long term planning area. Appears to be where task get added to the list [2] and others	01-01-00-003-05-16-16	3
18	[2] speaks up about the issue of profiles and should it be added to the list [4] says yes	01-01-00-003-05-16-16	3
19	[2] asks [4] about working on a task .this task is in their area of responsibility. [4] says] effort will be made to make time to support this planned task.	01-01-00-003-05-16-16	3

**Table 41: C5 Evidence Item (Portion)**

## CHANNEL SIX DEVELOPMENT FROM THE CSR DATABASE

Analyzing for elements of Channel Six, the researcher looked for areas that the project was monitored and controlled. A big area again was during the weekly meetings. Formal audits were conducted during a Program Management Review (PMR). Internal audits of the IPT (a

layer above the project team) and projects occurred (but not during this study). The project was questioned based on the auditor's team areas examined. The project lead, task lead, and BFM were primarily the ones involved in these types of audits. Channel evidence to support the existence of C5 is shown below in Table 42:

Item	Evidence Description	Data Source Code	C6
16	"Who/How is scheduling data provided? By whose direction?"	01-01-00-003-05-16-16	3
17	Discussion of adding task to long term planning area. Appears to be where task get added to the list [2] and others	01-01-00-003-05-16-16	3
31	Successful testing of system	01-00-00-001-05-18-16	3
32	Successful demonstration of system	01-00-00-001-05-18-16	3
83	They audit through SOVTs (System Operational Verification Tests)	01-07-02-008-06-27-16	3
84	[7] speaks with vendors that supply resources for the effort as do the team members	01-07-02-008-06-27-16	3
86	[7] tasking includes being AIT manager, SOVT coordinator, lead engineer for the project, and sub task coordinator	01-07-02-008-06-27-16	3
107	Project monitored at two levels: weekly with air logs that tell the story of what's going on and then during Program Management Reviews (PMR)	01-12-02-009-06-28-16	3

**Table 42: C6 Evidence Item (Portion)**

## CHANNEL ALGEDONIC DEVELOPMENT FROM THE CSR DATABASE

The algedonic channel was not very clearly visible between either going to S5 or to the Meta system of S3, S4, and S5 as the metasystem seemed to perform as a singular entity. In government organizations like this, and for this project, it was understood the project lead would be held accountable for all aspects of a project. Sponsors, external stakeholders, internal support competencies, and management alike often targeted the project lead not only for problems but for data request. Often data requests appeared to be treated as problems as they were the defense for a situation of concern. There was a channel that existed directly to the top: to the project lead.

Project 'Q' was modeled with the VSM where the S1's are shown below:

1. Government Oversight/Acquisition/Financial Management of Project 'Q'.
2. Fleet Engineering Support.
3. System Engineering Management.
4. Integrate, Assembly, & Test (Install/Remove) Production Support.

The S5 function was predominantly performed by project lead and BFM lead actions. The task leads of S1 worked with the project lead in the S3 functional role along with lead contractors at times. The S4 functional role was weak and difficult to distinguish as it appeared to be rolled up into S3 and S5 type functions. An effort was made to separate the S4 functional area. The communication channels development for the project focused on the six primary channels. Figure 27 below illustrates the project functional elements as they would look in the VSM model:

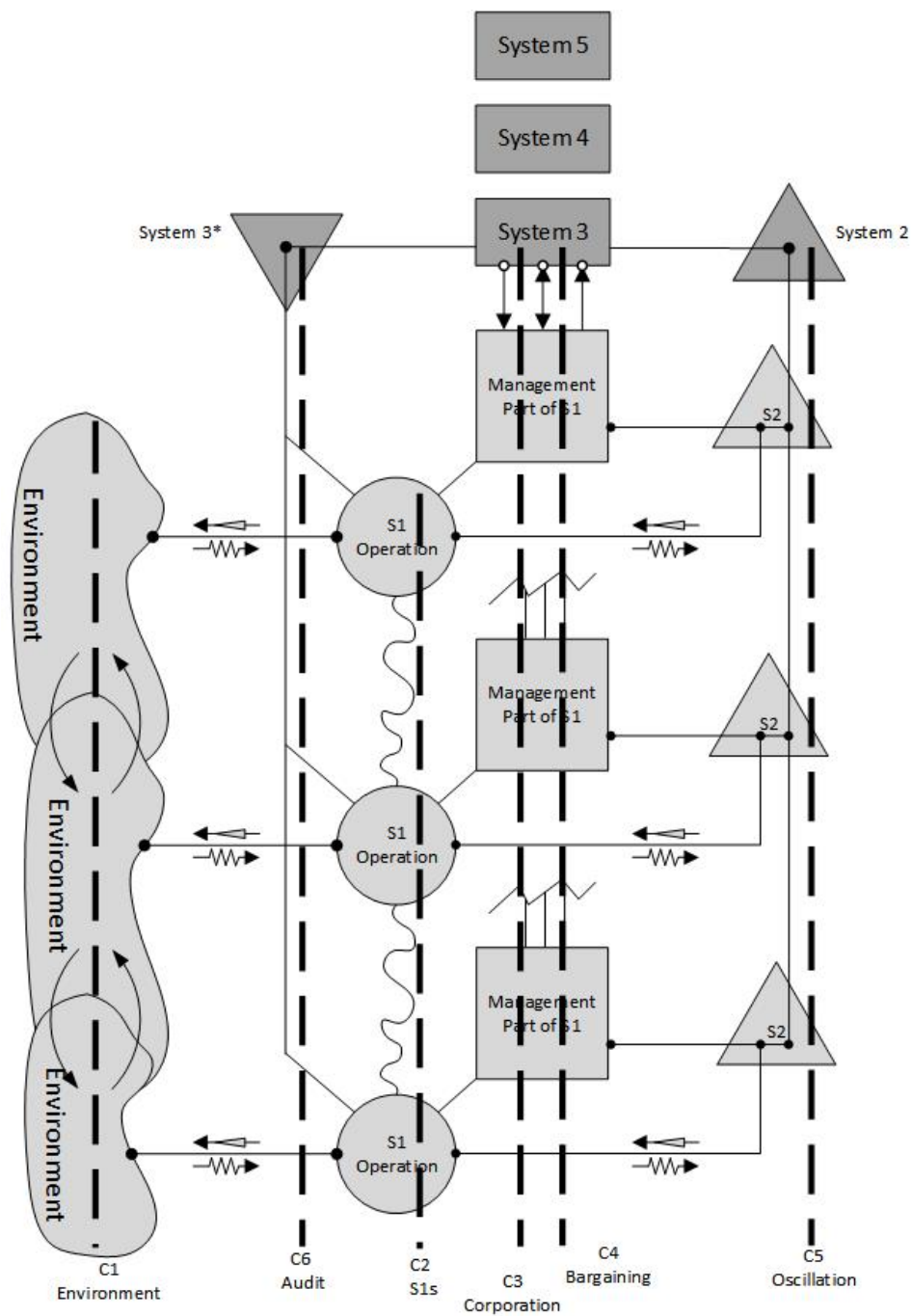

**Figure 27: VSM of Project (Systems and Channels are Described in the Preceding Narrative)**

## PROJECT 'Q' CASE STUDY SUMMARY

The adapted VSM model analysis of Project 'Q' indicated it could be mapped into the VSM. As the VSM looks at viability verses optimization, for example, it can be seen that the S3, S4, and S5 appear to collapse together, perhaps due to a weakly defined S4. The six primarily communication channels existed within this project.

Project 'Q' was modeled with the VSM where the S1's are defined below:

1. Government oversight of the project.
2. Fleet Engineering Support.
3. System Engineering Management.
4. Acquisition Management.
5. Financial Management.
6. Integrate, Assembly, & Test Production.
7. Removal of four (4) unit level variant. (Refers to an equipment suite – the unit level variant being the basic level unit of the installed equipment system).

The S5 function was predominately performed by the project lead, task leads, and BFM lead.

The task leads of S1 worked with the project lead in the S3 functional role along with lead. The S4 functional role was weak and difficult to distinguish as it appeared to be rolled up into S3 and S5 type functions. An effort was made to separate the S4 functional area. The communication channels development for the project focused on the six primary channels. All channels had representative links that would be expected in the VSM. This project at a minimum did contain all the elements needed for a project that would be modeled by the VSM and is illustrated below in Figure 28:

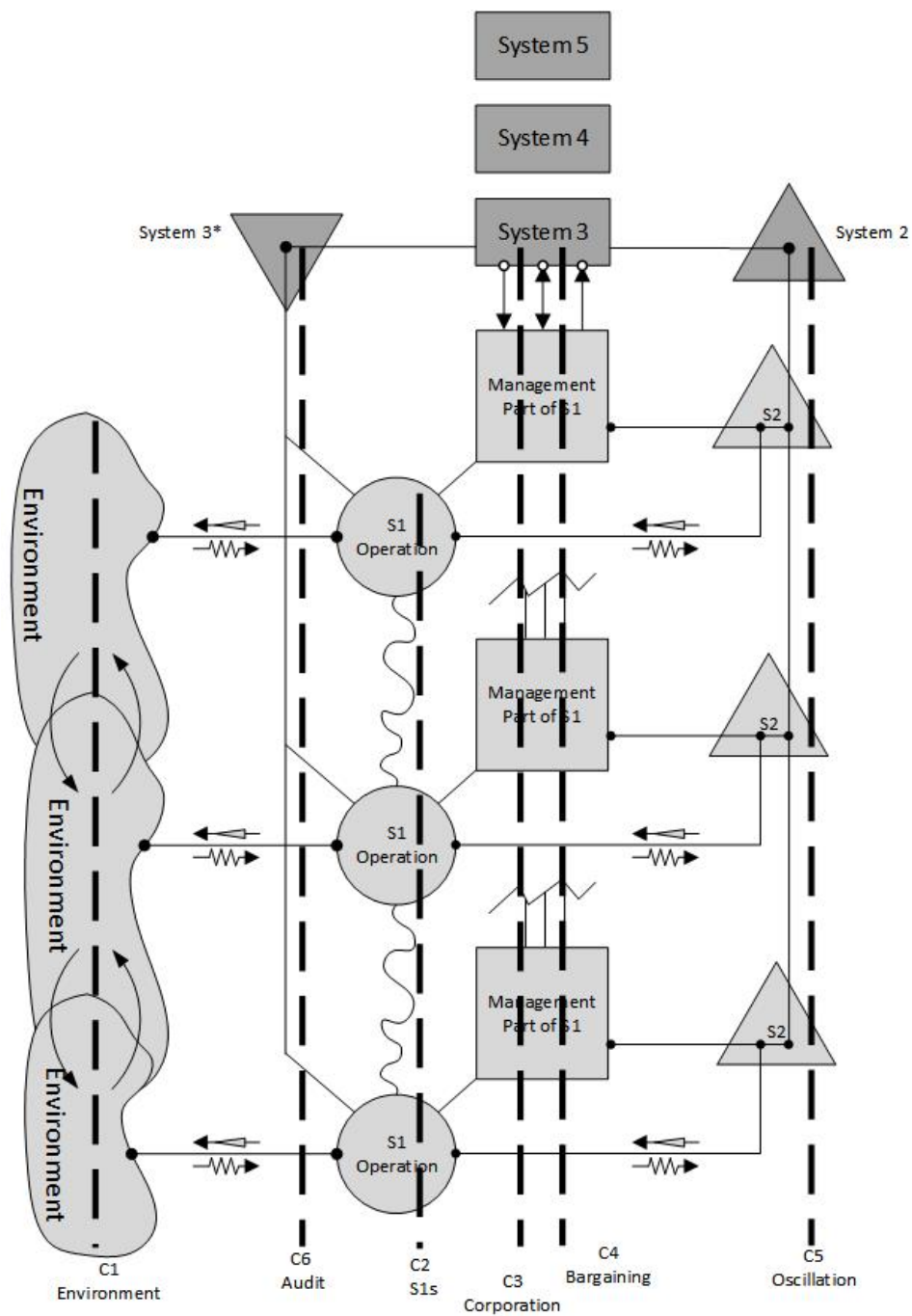

Figure 28: VSM of Project (Systems and Channels are Described in the Case Narrative)

In reviewing this project data, the systems and six primary channels did appear to meet at least minimum requirements in all areas. The S3-S4-S5 metasystem was seen to be more condensed into one system, but still met the minimal requirements by definition. The strategic functional area of the S4 was most notably not clearly defined. A separate functional area was deemed impractical due to the work load and emphasis was not placed in this area which was reflected in minimal discussion of strategic initiatives, etc. PMBOK (2013) notes without this functional area the link between the organization and the project team will lose this strategic element.

### **PROJECT 'Q' CASE STUDY CONCLUSION**

The case study narrative was developed from data collected from operational phase of a government engineering project. The project was analyzed using the VSM developed by Stafford Beer (1981) for use with organizational modelling and refined for use with this case study. The case study narrative was drafted in a structure that utilized the system and channels that were developed from the conceptual framework for data analysis.

The systems and six primary channels met at least minimum requirements in all areas. PMBOK (2013) notes without this functional area the link between the organization and the project team will lose this strategic element. The six primarily communication channels existed with this project. The supporting evidence items from the case study database linked the evidence to the definition of the Systems and Channels of the VSM.

One of the research questions for this study concerned how the Viable System Model (VSM) can be adapted for analysis of project management structure. To be appropriate for case

study research, data analyzed using the conceptual framework would have to be capable of being used to develop an accurate case narrative.

The case narrative was drafted and copies were distributed to the IPT Lead and participating Project 'Q' team members for review and comment. The project team was ask to make any corrections or comments that they deemed appropriate and provide written feedback. Copies of the draft case study narrative for Project 'Q' are exhibited in Appendix 1. Comments and corrections for the draft case study narrative for Project 'Q' are exhibited in Appendix 4. Review of the corrections and comments indicated no substantial inaccuracies noted in the reviewer's comments. The minor corrections and comments noted were corrected in the edition above. Grammatical and typographical errors which were noted were also corrected. The fact that there were few inaccuracies reported is evidence that the narrative reflects the model accurately depicting the project team's view of the project management structure of Project 'Q'. The project team's reflection served to verify that the data used to produce the narrative was accurate and is evidence that the conceptual framework used in the data analysis was appropriate for the system being studied and the case study research method that was used.



## **PROJECT T: A CASE STUDY**

### **INTRODUCTION**

The purpose of this study was to explore the applicability of the Viable System Model (VSM) as a framework for structural analysis of project management systems using a case study research design. This case study looked at the project management structure of an engineering project group within the government using the modified VSM framework as the analysis framework. The case study showed how the adapted VSM could be used to model a project's system structure and associated communication channels.

### **BACKGROUND**

Today's body of knowledge of complex project-based organizations often focuses on its project management systems and how the organization is structured hierarchically. The Viable System Model (VSM) developed by Stafford Beer was used to analyze an organization from a perspective that differed from the mainstream of the time. The VSM viewed structure not from a hierarchical view but rather the functional interaction of the individual systems and how they interacted iteratively. This study helped bridge the gap between the systems-based analysis of a project based organization and the analysis of its project management structure by using the VSM as an analysis framework for examination of viability. This paper used case study research as the rigorous methodology for research.

Case study research is used to enlighten and gain knowledge into complex social phenomena, which can be: a person, group of people, an organization, a social situation, or political phenomena (Yin, 2009). Yin states "the case study method allows investigators to retain

the holistic and meaningful characteristics of real-life events – such as individual life cycles, small group behavior, organizational and managerial process, neighborhood change, school performance, international relations and the maturation of industries” (2009, p. 4). Case study research is a way of researching an empirical topic by following a set of pre-specified procedures while reviewing the logic of design, the data collection methodology, and specifies a unique data analysis approach (Yin, 2009, pp. 18-21). Yin (2009) describes a linear, but iterative process for doing case study research in his book, *Case Study Research: Design and Methods*, 4<sup>th</sup> edition. The guideline goes through the following processes: plan, design, prepare, collect, analyze, and share along with iterations (Yin, 2009).

This research used the exploratory multiple case study as a methodology to study how the Viable System Model (VSM) could be adapted for analysis of the project management structure. The exploratory method was chosen as this is a “contemporary set of events” over which the researcher has little or no control concerning the organizational structure (Yin, 2009, p. 12). This rigorous case study was based on the technical definition of case study research by Yin (Yin, 2009, p. 18). The data was provided by the project leader to ensure all data was vetted through the project lead. Several sources were used during the CSR. The Bibliography of the Data Sources used for this case study and the associated dates the data was received or event (interview/observation) was performed are shown in Table 43 below:

Data Source File Number	Name	Date Received
1	PMP For [1]	7/18/2016
2	Org Chart	7/18/2016
3	Spend Plan	7/18/2016
4	[1] Weekly Team Minutes	7/18/2016
5	Interview With [0] Project Lead	8/11/2016
6	Interview with [16] Technical manager	8/12/2016
7	Sponsor Meeting Weekly	5/15/2016
8	Interview with [14] Logistics and CM	8/16/2016
9	Interview with [4] Video Task Lead	8/17/2016
10	Interview with [13] IA Manager	8/17/2016
11	Interview with [20] Engineer Support	8/17/2016

**Table 43: Bibliography of Data Sources and Dates Received**

After selection of the project for the case study, the researcher met with the project lead to get an understanding as to what was expected of the project team. The project lead was informed of the information/ material needed to be available to the researcher for this case study research. The researcher advised the project manager that a case study protocol would be used for the data analysis. The need to return and ask further clarifying questions or request further information was discussed. Being a knowledgeable project manager a bachelor's degree in Electrical Engineering and a master's in Engineering Management, the project manager was able to attain and gather several documents for review prior to the clarifying discussions with reviewers. The project team members were identified to the researcher. Volunteer members of the team would be consulted on the PMS of their project. Preliminary questions had been documented and were used for the CSR discussions and proved to be helpful in guiding the discussions and ensured the same basic questions were used throughout the initial phase of the discussion process. The information from the discussions was incorporated into the case study database for later use.

The data from the case study database was analyzed and grouped into theme areas that best matched the elements of the VSM: the Systems and the Channels. The results of the preliminary grouping began to describe the Systems and Channels. The case study data was then analyzed using the matrix analysis approach; the approach used for the VSM to PMBOK PMS structure matrix analysis. Each section was ranked 0-3 for content applicability to the VSM as shown below:

‘0’ - there is not a discernable explicit or implied acknowledgement in the PMBOK for the identified VSM system or communication channel.

‘1’ - there is not a discernable acknowledgement in the PMBOK for the identified VSM system or communication channel.

‘2’ - there is an implied acknowledgement in the PMBOK for the identified VSM system or communication channel, but not enough to stand on its own.

‘3’ - there is a discernable explicit or implied acknowledgement in the PMBOK for the identified VSM system or communication channel.

Evidence items that contained relevance (scored ‘3’) were used in the narrative to support the associated themes; i.e. S1, S2, C1, etc.

Once the case study database evidence items were grouped into themes, the Systems and Channels were drawn into the VSM to better visualize the results for the model of the project’s PMS. The tabular information best describes the elements that form the Systems and Channels, as the diagram is nearly identical to the proposed VSM model. An example of how System One themes were identified from the data is shown below in Table 44:

System	Definition(s)	Identifiers
S1	<p>Elements concerned with performing the key transformations of the organization; produces the products. (Beer, 1981)</p> <p>The autonomous unit that produces the product or service. (Beer, 1981)</p>	<p>Produces the product or service; only system that is autonomous/viable by itself. (Beer, 1981)</p> <p>Operates autonomously within agreed parameters. (Keating, et al, 2012)</p> <p>Produce systems product and services to agreed-upon standards and performance levels within the allocated resources. (Keating, et al, 2012)</p> <p>Interface with S2 for coordination within the larger systems. (Keating, et al, 2012)</p> <p>Provide direct interface to the local system environment. (Keating, et al, 2012)</p>

**Table 44: S1 System Description**

Table 44 shows how the System One Identifier information from the VSM model was matched with the data from the case study database. The Systems and Channel information formed the basis of the narrative themes. The triangulation of evidence data in the case study database with the identifier information for systems and channels for the VSM are how the project's VSM model was developed. The matrix analysis was performed for each System and Channel themes within the case study database evidence entries. The data was used to form the case narrative and the adapted VSM model for the project. The linkage back to the source data was maintained.

The case study data was used to update the basic VSM model as shown below in Figure 29. Consistent with the research design, the researcher first identified the Systems and followed that with the identification of the primary six Communication Channels. Each system and channel was described individually to better highlight the relationship with the case study

database evidence items. The individual components of the model were then combined into the Project 'Q' VSM at the conclusion of the case narratives.

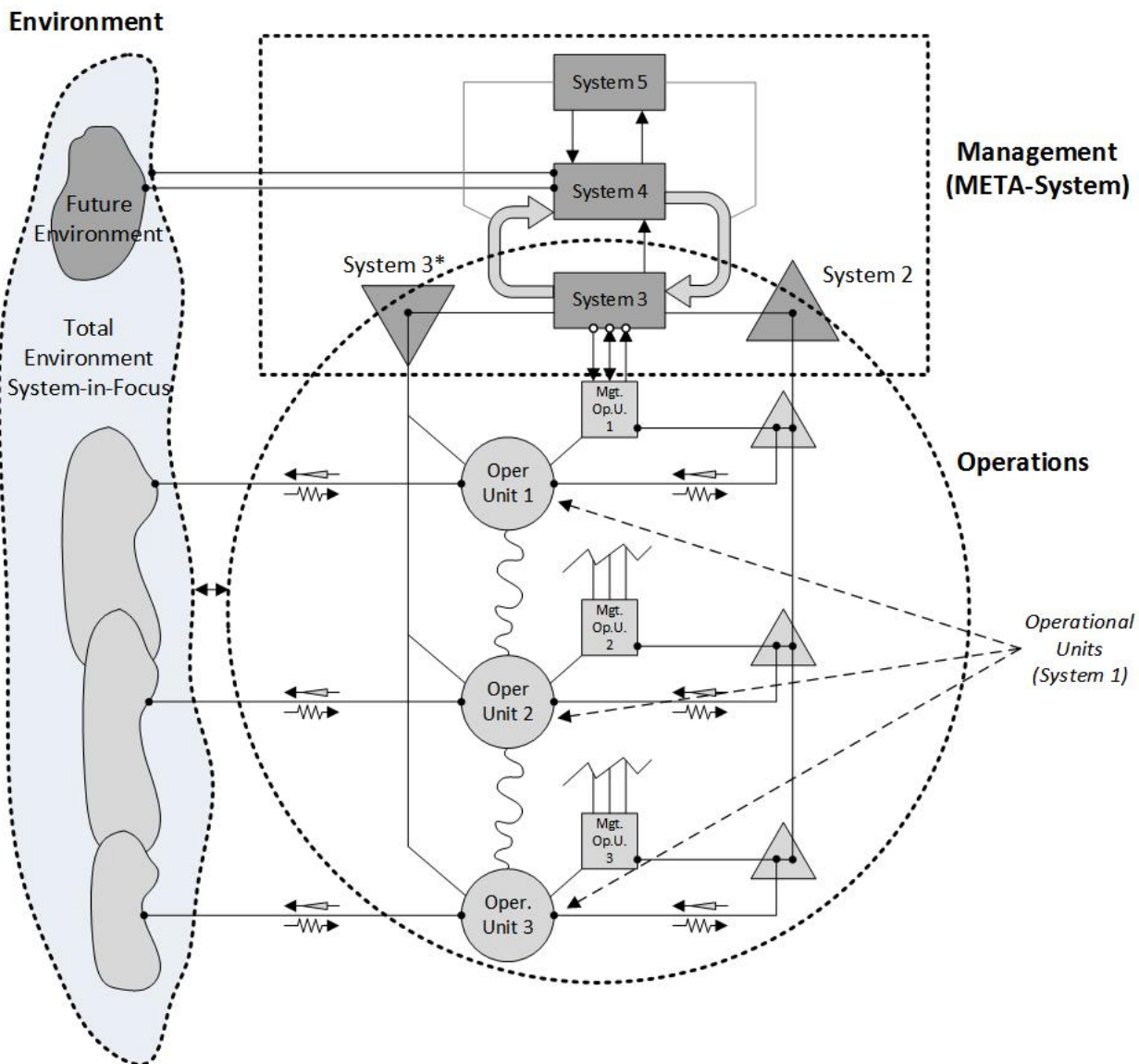

**Figure 29: Preliminary VSM Diagram for a Project**

## **SYSTEM ONE DEVELOPMENT FROM THE CSR DATABASE**

The primary System One functions of this project were the tasking that the sponsor had funded and passed on to the project team in the form of the task planning letters and associated funding documents. The tasks descriptions are summarized for Project 'T' as shown below:

1. Fleet Support/ISEA
2. IP Trunking
3. RTMS
4. TUMS
5. VoSIP
6. VTCoSIP
7. VCS Expressway
8. NVCS
9. Aegis Ashore
10. Government oversight of Telephony Tasks

The System One's contained the scheduling data for the tasks. The System One's identified what resources were scheduled and defined. The definition of the tasks of the task leaders was described and identified as the S1's. System One definitions and identifiers used for analysis are shown for reference below in Table 45:

System	Definition(s)	Identifiers
S1	<p>Elements concerned with performing the key transformations of the organization; produces the products. (Beer, 1981)</p> <p>The autonomous unit that produces the product or service. (Beer, 1981)</p>	<p>Produces the product or service; only system that is autonomous/viable by itself. (Beer, 1981)</p> <p>Operates autonomously within agreed parameters. (Keating, et al, 2012)</p> <p>Produce systems product and services to agreed-upon standards and performance levels within the allocated resources. (Keating, et al, 2012)</p> <p>Interface with S2 for coordination within the larger systems. (Keating, et al, 2012)</p> <p>Provide direct interface to the local system environment. (Keating, et al, 2012)</p>

**Table 45: S1 Definition/Identifiers**

The System One definitions and identifiers from Table 45 above were used in a matrix analysis of evidence items within the CSR database. The portion of evidence items that support the findings of a System One in the project are shown below in Table 46:

Item	Evidence Description	Data Source Code	S1	S2	S3	S3*	S4	S5	C1	C2	C3	C4	C5	C6	Alg
2	The project supports ISEA services, JITC testing, overall engineering and support for [01] (and anything related) [02].	02-01-00-001-07-28-16	3		3		2	3	1	2	3	3			1
3	Deliverable: JITC approved facility/products and enterprise engineering support/related documentation.	02-01-00-001-07-28-16	3	1	3	3	2	3	1	3	2	2			
4	Project team identified hierarchically; PM [01], BFM [02],[3]-[11].	02-01-00-001-07-28-16	3	1	3	3	2	3	1	3	3	3			3
5	PMP, Configuration plan, quality assistance plan, and risk management plan identified as part of PMP.	02-01-00-001-07-28-16	3	2	3	3	3	3	1	3	3	3	1	3	3
6	The [01] Requirements Management (REQM) Plan documents project requirements.	02-01-00-001-07-28-16	3	1	3	3	2	3	1	3	3	3	1	3	
7	REQM Project processes for interpretation, agreement, and commitment to management and technical requirements.	02-01-00-001-07-28-16	3	1	3	3	2	3	1	3	3	3	1	3	
8	Project approach to requirements documentation, traceability, and addressing changes.	02-01-00-001-07-28-16	3	1	3	3	2	3	1	3	3	3	1	3	
9	Reviews and other mechanisms to ensure that inconsistencies between requirements, project plans, and work products are identified, tracked, and resolved.	02-01-00-001-07-28-16	3	1	3	3	2	3	1	3	3	3	1	3	
10	The project schedule baseline is captured in Appendix B and will be updated on a weekly basis, or as necessary to reflect current data. In order to maintain an efficient project schedule.	02-01-00-001-07-28-16	3	1	3	3	2	3	1	3	3	3	1	3	

**Table 46: S1 Evidence Item (Portion) from Case Study Database**



The evidence items of the case study database used to support the definition of S1's in this case is seen in Table 46 above. The nine tasks identified in this case represent the S1's mapping to the VSM. The supporting evidence items that scored '3' occurred ten times. The Case Study Database (CSD) contains all the case evidence for all the Systems and Channels, only a portion is shown here for demonstrative purposes. The evidence establishes that for this case S1's can be represented in the VSM.

## **SYSTEM TWO DEVELOPMENT FROM THE CSR DATABASE**

The System Two can best be described as the working relationship between the individual tasks leads and the interaction with the project lead. The System Two contained the anti-oscillatory actions between the S1s. Definition of the tasks of the task leaders was described. S2 definitions and identifiers are shown below in Table 47:

System	Definition(s)	Identifiers
S2	<p>Anti-oscillatory regulatory, input filter to S3. (Beer, 1981)</p> <p>Divisional/Corporate regulatory. (Beer, 1981, p. 157)</p> <p>Metasystem subsuming all S1's. (Beer, 1981, p. 172)</p>	<p>Coordinator, preventing oscillations. (Beer, 1981, p. 160)</p> <p>Elaborate interface between S1 and S2. (Beer, 1981)</p> <p>Monitors what S1 does. (Beer, 1981)</p> <p>Input filter to S3. (Beer, 1981)</p> <p>Services S1 and is not a command channel. (Beer, 1979)</p> <p>Not routine services, but anti-oscillatory. (Beer, 1979)</p> <p>Must be recognized by the observer. (Beer, 1979, p. 189)</p> <p>"To avoid explosion is minimally to constrain freedom". (Beer, 1979, p. 190)</p> <p>Maintain coordination among S1's. (Keating, et al, 2012)</p> <p>Promote system efficiency amongst S1s. (Keating, et al, 2012)</p> <p>Identify and manage emergent conflict between S1s. (Keating, et al, 2012)</p> <p>Identify system integration issues for system level resolution. (Keating, et al, 2012)</p>

**Table 47: S2 Definitions/ Identifiers**

This anti-oscillatory interaction usually occurred at the weekly project meetings, at a PMR, or through email discussions. The function of System Two was to prevent oscillation between the System One's with respect to resources and other needs. The project lead sent an aggregated task proposal/estimate to the sponsor. The sponsor worked with the project lead to accept and approve the estimate intended to be funded. The agreement of this interaction was accomplished when the sponsor sent the task planning letters and acceptance of this tasking letter by the project and organization was confirmed. The funding document was the actual dollars sent to the project for utilization. As the project team broke down the project into identifiable tasks, from the now aggregated estimate which was modified by the sponsor, the government tasks

leads used their previous estimates to baseline schedules, funding allocations, contract support, etc. The project lead accepted the tasking and determined tasking to be in accordance with funding. The discussions on funding differences were typically between the task leads and the project lead along with the BFM (others were included both for learning and to be informed). If the problem was not resolved between the S1's at the S3 level, the problem would have escalated to the S5 level for resolution.

The anti-oscillatory functions occurred in the weekly meeting with the sponsors, the task leads, and project lead. This was the occasion where the task leads got together and discussed resource needs and challenges. The bargaining of resources also occurred during this period. This combination of management and the sponsors within the project's S2 area of functionality is different than would be expected in the VSM. The project lead provides oversight of the multiple project tasks but it is the task leads that report to the sponsor on the status and updates of the tasks during working meetings. This illustrated a merging of the S3-S4-S5 responsibilities.

### **SYSTEM THREE AND THREE\* (STAR) DEVELOPMENT**

The System Three function was comprised of the task leads, the project lead, the BFM, contractor team lead, and the sponsor. This functional role was exercised during weekly meetings, government oversight functions, and contract negotiations. The "here-and-now" (Beer, 1981) of the current tasking and associated schedules were discussed during these meetings. Resources were also identified, tracked, and reported during these System Three level meetings. The information was then processed for distribution amongst the task leads and their team members, usually sent via email.

The System Three and Three\* (Star) contained the first level management of the project and also the monitoring and control functions for the project. Definition of the S3 and S3\* (Star) tasks were described earlier in the document and are shown below in Tables 48 and Table 49 respectively:

System	Definition(s)	Identifiers
3	<p>Provides interface with S4 and S5 structures and controls that establish rules, resources, rights, and responsibilities of S1. (Beer, 1982)</p> <p>Operative management. (Ríos, 2012)</p> <p>Highest level of autonomic management. (Beer, 1981, pp. 175-176)</p> <p>Lowest level of corporate management. (Beer, 1981)</p> <p>Govern the stability of the internal environments of the project. (Beer, 1981)</p> <p>Transmitter of policy/special instructions to the divisions. (Beer, 1981)</p> <p>Tracer of information of internal environment: metasystem controller downward, senior filter of information upward.</p> <p>Handles S2 information circuits. (Beer, 1981)</p>	<p>Highest level of autonomic magnet and the lowest level of corporate management of the systems in focus. (Beer, 1981, p. 175)</p> <p>Transmitter of policy and special instructions to the divisions/S1s. (Beer, 1981. p. 176)</p> <p>Recover of information of the internal environment; sends information upwards and downwards; only recovery of information upward from S2. (Beer, 1981, p. 176)</p> <p>Aware of what's going on inside the firm now. (Beer, 1979, p. 202)</p> <p>Manage the 'here and now' of the organization. (Ríos, 2012)</p> <p>Describing the channels between S4 and S3. (Ríos, 2012)</p> <p>Facilities resources communications between representatives form S3 and S4. (Ríos, 2012)</p> <p>Methodological and functional communications trough models and tools. (Ríos, 2012)</p> <p>Setting goals.</p> <p>Negotiating resources.</p> <p>Accountability procedures.</p> <p>Marketing's, sales, human resources, productivity and quality, production and operation, engineering, accounting, budgeting (Ríos, 2012).</p> <p>Handles divisional interactions (Beer, 1981). This is where the financial director, a production director, and as sale director would operate. "Each of them is setting out to integrate the work from the respective divisional managers" (Beer, 1979, p. 202) synergy policies.</p> <p>Operational planning and control for ongoing system performance (Keating, et al, 2012).</p> <p>Interprets and implements policies from S5, Interfaces with S4 to redesign operation in response and identification of environmental changes (Keating, et al, 2012).</p>

**Table 48: S3 Definition/Identifiers**

System	Definition(s)	Identifiers
S3*	Audit channel. (Beer, 1981)	<p>Highest level of autonomic magnet and the lowest level of corporate management of the systems in focus. (Beer, 1981, p. 175)</p> <p>Transmitter of policy and special instructions to the divisions/S1s. (Beer, 1981, p. 176)</p> <p>Recover of information of the internal environment; sends information upwards and downwards; only recovery of information upward from S2. (Beer, 1981, p. 176)</p> <p>Monitor Subsystems and system level performance. (Keating, et al, 2012)</p> <p>Identify and analyze deviant performance, unexpected crisis, and operational conditions and trends. (Keating, et al, 2012)</p>

**Table 49: S3\* (Star) Definitions/Identifiers**

System Three provided the project lead reports based on templates provided by the project lead. The System Three area is where collaboration and bargaining between the S1's was managed. System Three\* (Star) was executed through internal audits and PMRs. The internal audits were initiated by organizational policy and procedure reviews which looked to the project leads to provide artifacts for their defense. The PMR initiated by the program sponsors was an effort to ensure tasking was being performed as agreed upon in the task planning letters, representing a S3\* (Star) function. Project leads also performed unscheduled visits to the work areas to monitor project activities, another S3\* (Star) function. Similar requests for statuses that were not routine were identified in emails from the project lead to the team members. Evidence Items that support the S3 and S3\*(Star) of the VSM models are shown below in Table 50:

Item	Evidence Description	Data Source Code	S1	S2	S3	S3*	S4	S5	C1	C2	C3	C4	C5	C6	Alg.
1	The project supports [02]. Deliverable: JITC approved facility/products and enterprise engineering support/related documentation.	02-01-00-001-07-28-16	1		3			1	3	1	1	1	1		
3	Project team identified hierarchically: PM [01], BFM [02],[3]-[11].	02-01-00-001-07-28-16	3	1	3	3	2	3		1	3	2	2		
4	PMP, Configuration plan, quality assistance plan, and risk management plan identified as part of PMP.	02-01-00-001-07-28-16	3	1	3	3	2	3		1	3	3	3		3
5	The [01] Requirements Management (REQM) Plan documents project requirements.	02-01-00-001-07-28-16	3	2	3	3	3	3		1	3	3	3	1	3
6	REQM Project processes for interpretation, agreement, and commitment to management and technical requirements.	02-01-00-001-07-28-16	3	1	3	3	2	3		1	3	3	3	1	3
7	Project approach to requirements documentation, traceability, and addressing changes.	02-01-00-001-07-28-16	3	1	3	3	2	3		1	3	3	3	1	3
8	Reviews and other mechanisms to ensure that inconsistencies between requirements, project plans, and work products are identified, tracked, and resolved.	02-01-00-001-07-28-16	3	1	3	3	2	3		1	3	3	3	1	3
9	The project schedule baseline is captured in Appendix B and will be updated on a weekly basis, or as necessary to reflect current data. In order to maintain an efficient project schedule.	02-01-00-001-07-28-16	3	1	3	3	2	3		1	3	3	3	1	3
10	Task duration will be no less than 1 week (40 hours) for any project with a weekly update requirement.	02-01-00-001-07-28-16	3	2	3	3	1	3		1	3	3	3	2	3
11	No task will extend beyond 44 days (2 months) as this will cause a loss of fidelity in the project schedule.	02-01-00-001-07-28-16	3	2	3	3	1	3		1	3	3	3	2	3
12															

**Table 50: Evidence Items for S3 and S3\* (Star) (Portion) from the Case Study Database**

A portion of the evidence data for S3 and S3\* (Star), shown above in Table 50, is used for illustrative purposes. The data is sorted based on the System or Channel. The evidence shows ‘3’ was scored ten times and represents a fit into the VSM model. The Case Study Database (CSD) contains all the case evidence for all the Systems and Channels. The evidence items of the case study database used to support the definition of S3 and S3\*(Star), in this case are seen in Table 50 above. The supporting evidence items that scored ‘3’ occurred ten times. The Case Study Database (CSD) contains all the case evidence for all the Systems and Channels, and only a portion is shown here for demonstration purposes. The evidence establishes that for this case S3 and S3\* (Star),’s can be represented in the VSM.

**SYSTEM FOUR DEVELOPMENT FROM THE CSR DATABASE**

The System Four was the most difficult to identify. In talking with the team members, most felt they got their strategic views from the program office/sponsor. This was reflected in the

weak identity the group had as a project team within this organization. Within a competency aligned organization, the project team, based on competency assignments, are members of a competency as well that provided human resources to the projects. In talking with the project lead, the strategic planning went beyond the future phase and into conversations with vendors and other organizational members. The project lead suggested that the team barely has time to complete current tasks and feels as though he runs around 'putting fires out with a fire hose'. Task leads discussed future planned efforts formally but strategic tasking was more of an informal process at this time. The project lead and task leads merged the task of developing a model of the status of the projects to be passed up to management and associated customers/stakeholders that warranted the reporting. The future based discussion that did occur occurred between the project lead and task leaders (and any potential stakeholders) were at best referred to as informal discussions. The System Four should contain the forward looking area of the project. Definition of the tasks of the S4 system was described earlier in the document. System Four definitions and identifiers are shown below in Table 51 and Table 52 respectfully:



System	Definition(s)	Identifiers
S4	<p>Development directorate of the organization. (Beer, 1981, p. 181)</p> <p>Detecting and conveying changes and needs determined by the evolution of the environment and conveying this to the interior organization. (Ríos, 2012)</p> <p>Strategic management. (Ríos, 2012)</p> <p>Elements which look outward to the environment to understand how the organization needs to adapt to remain viable. (Beer, 1981)</p> <p>The model S4 use helps to facilitate the examination of corporate plans on the indefinite time-base which invalidates so many static models of the corporate economy. (Keating, , et al, 2012)</p>	<p>A description of management and individual's purpose is S4. (Ríos, 2012)</p> <p>Explicit descriptions of activities that each individual does for S4. (Ríos, 2012)</p> <p>Means that organization supports S4 efforts. (Ríos, 2012)</p> <p>Simulation models, tools for carrying out prospective studies, methods employed to explore alternative decisions, decision area. (Ríos, 2012)</p> <p>Elements or physical visualizations of past/present/modeled data for decision making. (Ríos, 2012)</p> <p>Environment areas to account for include: commercial, social, demographic, technological, political, legal, economic, ecological, and educational. (Ríos, 2012)</p> <p>Sensor, transducers channels of communications analysis of how to make these work. (Ríos, 2012)</p> <p>Awareness of how data/information is captured viewed/presented and associated characteristics. (Ríos, 2012)</p> <p>Review of vision, mission, objectives, business model, profitable growth areas, new challenges, and chances for transformation as desired, expansions, etc. (Ríos, 2012)</p> <p>Information switch between S3/S5 filtered. (Beer, 1981)</p> <p>Foster strategic learning, development, and transformation. (Keating, et al, 2012)</p> <p>Maintain environmental scanning, analysis, and interpretation. (Keating, et al, 2012)</p> <p>Maintain models of the systems for other subsystems and the environment; guides system transformation; identify system trends and patterns. (Keating, et al, 2012)</p>

**Table 51: S4 Definition/Identifiers**

Item	Evidence Description	Data Source Code	S1	S2	S3	S3*	S4	S5	C1	C2	C3	C4	C5	C6	Alg
67	Team works off the Integrated Master Schedule (IMS) from the program office [1] other groups work off this same schedule. Task that are funded and worked are reported on weekly.	02-16-02-006-08-12-16	3	2	3	3	3	3	3	3	3	3	3	3	3
68	Spend Plan indicates which tasks are funded and are tasks from the IMS that [1] controls	02-16-02-006-08-12-16	3	2	3	3	3	3	3	3	3	3	3	3	3
74	Stakeholders are sponsor, team, ccustomers	02-16-02-006-08-12-16	3	1	3	1	3	3	2	3	2	2	1	3	
77	IMS drives all actions and tasks...PL talk directly with Sponsor teams...PL mitigates Monitoring of projects through meetings, PMR, and internal competency audits of processes and procedures	02-16-02-006-08-12-16	3	2	3	2	3	3	3	3	3	3	3	3	3
81	Again IMS holds tasking that gets into spend plans as tasking to the project....their portion is a portion of an overall effort maintain by the project's sponsor	02-16-02-006-08-12-16	3	2	3	3	3	3	2	3	3	3	3	3	3
82	Sponsor weekly meeting going done IMS schedule discussing items and adjusting issues as permitted	02-00-01-007-08-15-16	3	2	3	3	3	3	2	3	3	3	3	3	3
83	Project team is updating org chart for the sponsor due to more new people on the project	02-00-01-007-08-15-16	3	1	3	1	3	2	1	3	3	3	1	2	
84	Sponsor changed the priority lists of task and was advising everyone....later observer asked PL who was taking minutes and he mentioned sponsor took overall notes and sends out the minutes...individuals at the meeting appear to take notes related to their tasks only	02-00-01-007-08-15-16	3	1	3		3	3	1	2	1		1	3	

**Table 52: S4 Evidence Item (portion) from the Case Study Database**

The evidence items of the case study database used to support the definition of S4’s in this case is seen in Table 52 above. The supporting evidence items shown that scored ‘3’ occurred 5 times. The Case Study Database (CSD) contains all the case evidence for all the Systems and Channels, only a portion is shown here for demonstration purposes. The evidence establishes that for this case S4’s can be represented in the VSM, but the weak separation of S3-S4-S5 must be noted.

**SYSTEM FIVE DEVELOPMENT FROM THE CSR DATABASE**

The System Five identity of the project centered on the project lead and the BFM which had final negotiating authority over the tasking the project accepted. The tasks leads primarily associated with the S1 were seen represented in the S5 area as well. The sponsor informally dictated the name of the project based on the way estimates were routed up the government channels for approval and provided the source of funding. The reverse path was similar but was

not exactly the same based on the requirements and priorities determined at each level of appropriation. The funding document was the determining factor as to what the project was in the situation of the funding document matching requirements of the funded tasking. The project lead maintained the final authority for project related decisions within the organization and also was responsible for all the processes, data calls, and organizational procedures to be followed. The project was autonomous, but not purely. Organizational management requirements occurred and needed to be passed down appropriately to the team. The System Five contained the project's identity and final decision point. Definition of the S5 tasks was described earlier in this document. System Five definitions and identifiers are shown below in Table 53 and Table 54, respectfully:

System	Definition(s)	Identifiers
S5	<p>Responsible for policy and decisions. (Beer, 1981)  "Collegiate authority".  (Beer, 1981, p. 154)  Provides the identity of the organization. (Beer, 1981)  Responsible for achieving equilibrium between the present functioning of the organization and its preparation for the future. (Ríos, 2012)  Creates policy decisions within the organization as a whole to balance demands from different organizations and provide direction to the organizational as a whole. (Beer, 1982)  Normative management. (Ríos, 2012)</p>	<p>Looks at needs of divisions and may sacrifice resources for the greater good. (Beer, 1981, p. 160)  Operations room environment available. (Beer, 1981)(Ríos, 2012)  Provides Identity of the organization. (Beer, 1981)  Resources that actually make up S5 identified. (Ríos, 2012)  Procedures to communicate strategic plan/identity to the organization. (Ríos, 2012).  Are channels in place to communicate S5 needs, sensors, emergency access to S5 i.e. functional? (Ríos, 2012)  Interaction between S3/S4 with S5 to maintain equilibrium/resolve S3/S4 issues. (Ríos, 2012)  Develop system policy and direction. (Keating, et al, 2012)  Strategic goals/objectives written. (Ríos, 2012)  Monitors vertical command axis for obeying instructions.(Beer, 1981, p. 159)  Formal declaration of vision, mission, purpose. (Ríos, 2012)  Represent and communicate the system to external entities; process input/outputs forms other subsystems; establish system policy and strategic direction. (Keating, et al, 2012)  Propagate system identity; maintain and propagate mission/vision/identity. (Keating, et al, 2012)  Balance systems focus between S3 and S4. (now and future) (Keating et al, 2012)</p>

**Table 53: S5 Definition/Identifiers**

67	Team works off the Integrated Master Schedule (IMS) from the program office [1] other groups work off this same schedule. Task that are funded and worked are reported on weekly.	02-16-02-006-08-12-16	3	2	3	3	3	3	3	3	3	3	3	3	3
68	Spend Plan indicates which tasks are funded and are tasks from the IMS that [1] controls	02-16-02-006-08-12-16	3	2	3	3	3	3	3	3	3	3	3	3	3
74	Stakeholders are sponsor, team, ccustomers	02-16-02-006-08-12-16	3	1	3	1	3	3	2	3	2	2	1	3	
77	IMS drives all actions and tasks...PL talk directly with Sponsor teams...PL mitigates Monitoring of projects through meetings, PMR, and internal competency audits of	02-16-02-006-08-12-16	3	2	3	2	3	3	3	3	3	3	3	3	3
81	processes and procedures	02-16-02-006-08-12-16	3	2	3	3	3	3	2	3	3	3	3	3	3
82	Again IMS holds tasking that gets into spend plans as tasking to the project....their portion is a portion of an overall effort maintain by the project's sponsor	02-16-02-006-08-12-16	3	2	3	3	3	3	2	3	3	3	3	3	3
83	Sponsor weekly meeting going done IMS schedule discussing items and adjusting issues as permitted	02-00-01-007-08-15-16	3	2	3	3	3	3	2	3	3	3	3	3	3
84	Project team is updating org chart for the sponsor due to more new people on the project	02-00-01-007-08-15-16	3	1	3	1	3	2	1	3	3	3	1	2	
85	Sponsor changed the priority lists of task and was advising everyone....later observer asked PL who was taking minutes and he mentioned sponsor took overall notes and sends out the minutes...individuals at the meeting appear to take notes related to their tasks only	02-00-01-007-08-15-16	3	1	3		3	3	1	2	1		1	3	

**Table 54: S5 Evidence Item (portion) from the Case Study Database**

The evidence items of the case study database used to support the definition of S5 in this case is seen in Table 54 above. The supporting evidence item shown scored ‘3’ occurred more seven times. The Case Study Database (CSD) contains all the case evidence for all the Systems and Channels, only a portion is shown here for demonstration purposes. The evidence establishes that for this case S5 can be represented in the VSM.

**CHANNEL DEVELOPMENT FROM THE CSR DATABASE**

The next phase dealt with modeling the communication channels of the project to the VSM. The communication channels in the VSM are the elements that connect both the diverse functions specified in the VSM and the organization with its environment(s) (Ríos, 2012). The channels provide the equilibrium, balance or homeostasis of the internal environment of the system in view. The six primary channels of the VSM can be characterized as follows (Ríos, 2012, p. 61):

1. Channel One - C1 - Channel connecting and absorbing variety between the environments of each elementary operational unit.
2. Channel Two - C2 - Channel connecting the various elemental operations (operational units making up System One).
3. Channel Three - C3 - Corporate intervention channel (System Three-System One).
4. Channel Four - C4 - Resources bargaining channel (System Three – System One).
5. Channel Five - C5 - Anti-oscillatory channels (Co-ordination) (System Two).
6. Channel Six - C6 - Monitor channel (Auditor).
7. Algedonic Channel - Transmits alert signal concerning any event or circumstance that could jeopardize the organization. Travels straight to the top through existing links.

The six primary VSM communication channels can be seen in Figure 30 below:

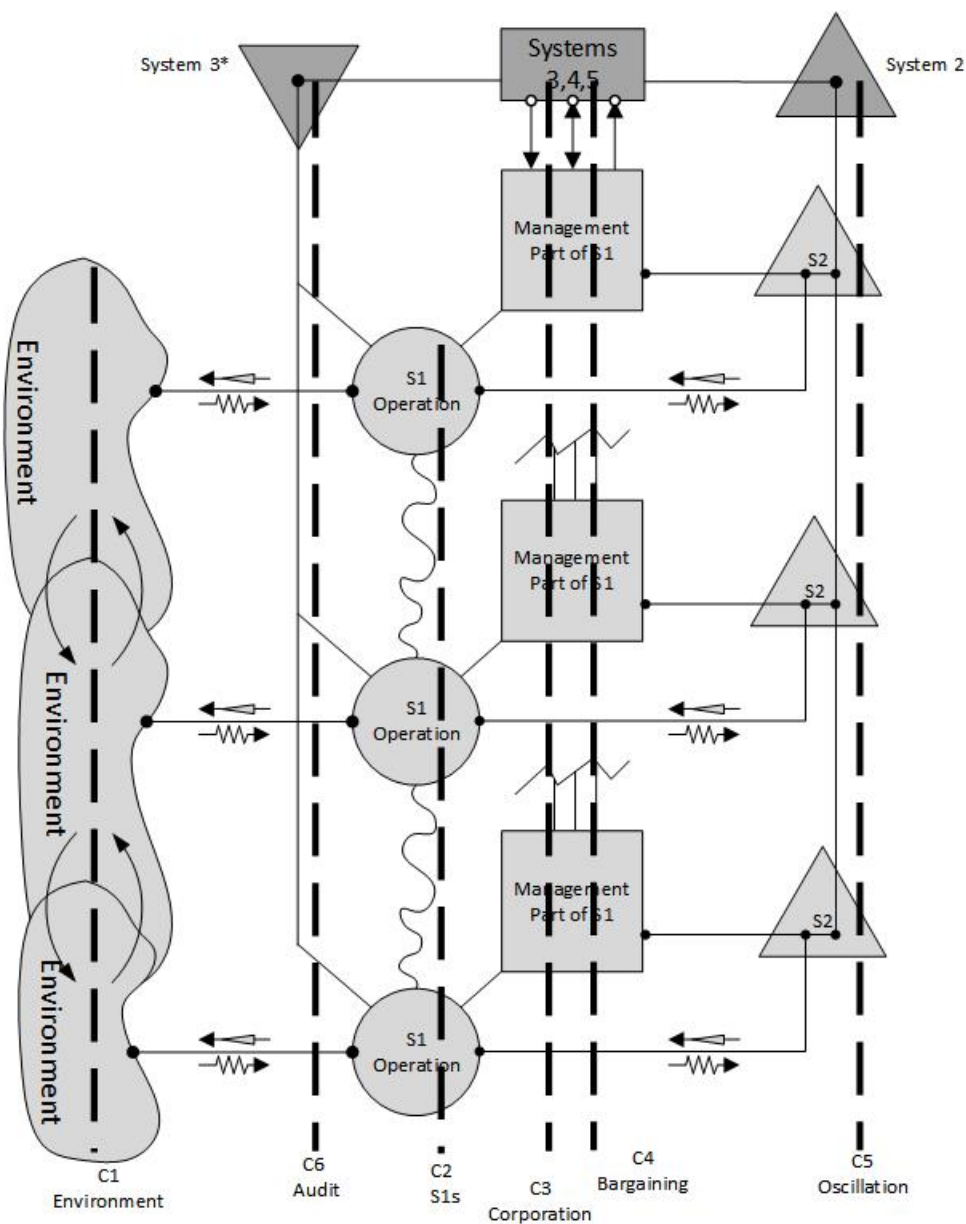

**Figure 30: The Six Primary Communication Channels of the VSM**

The case study database and the available artifacts provided were examined to develop and validate the use of the six primary channels of the VSM. The project lead provided a

hierarchical diagram of how the project was organized and can be seen in the PMP (Project Management Plan). The channel development used the communication channel definitions and identifiers used earlier in the document. The analysis of the evidence items were performed similarly to the Systems development and used to identify the models communication channels. The next sections summarize the linkage between Definition/Identifiers to the case study database evidence items.

### **CHANNEL ONE DEVELOPMENT FROM THE CSR DATABASE**

Analyzing for elements of Channel One, the researcher looked for communication channels connecting and absorbing variety between the environments of each identified operational unit (S1). The case study database was analyzed for themes that would support the presence of C1's in this case. The following case study data supports the presence of the C1's shown in Table 55 below:



Item	Evidence Description	Data Source Code
55	When task leads have issues they can't handle they bring up to meeting to discuss	02-00-02-005-08-11-16
67	Team works off the Integrated Master Schedule (IMS) from the program office [1] other groups work off this same schedule. Task that are funded and worked are reported on weekly.	02-16-02-006-08-12-16
68	Spend Plan indicates which tasks are funded and are tasks from the IMS that [1] controls	02-16-02-006-08-12-16
76	CASREPS and 301 tickets are another feedback path. Positive feedback may come from an occasional sponsor good word	02-16-02-006-08-12-16
77	IMS drives all actions and tasks...PL talk directly with Sponsor teams...PL mitigates Sponsor discussing customer feedback and requirements request while trying to validate them to their IMS tasking schedule; Sponsor asked for feedback on some tasks; Appeared to be working level discussion for the project where the sponsor was like the PL	02-16-02-006-08-12-16
86	Appeared to be working level discussion for the project where the sponsor was like the PL	02-00-01-007-08-15-16
87	Appeared to be working level discussion for the project where the sponsor was like the PL	02-00-01-007-08-15-16
88	Sponsor seemed to ask allot of question as to the status of events as there appeared to be no written updates ..perhaps this is where the updates occurred...	02-00-01-007-08-15-16

**Table 55: C1 Evidence Items from Case Study Database (Portion)**

The case reflected where the contractors were supporting multiple task leads communicated and worked together to support the overall project goals. Although each had an autonomous purpose based on the tasking, they still participated in the overall project. The evidence supports the presence of C1 channels as defined by the VSM.

## **CHANNEL TWO DEVELOPMENT FROM THE CSR DATABASE**

Analyzing for elements of Channel Two, the researcher looked for the Communications Channel connecting the various operational (S1s) units. Communications between the S1's usually occurred at the weekly meetings. Minutes were generated and distributed. Each of the weekly meetings discussed current resources used and planned resources for all nine tasks within the project. BFM and contractor provided financial data was reviewed to ensure work

progression as expected along with expenditures. Discussion of shared resources occurred often as the overall project was operating on limited resources. The case study database was analyzed for themes that would support the presence of C2's in this case. The following case study data supports the presence of the C2's shown in Table 56:

Item	Evidence Description	Data Source Code
4	Project team identified hierarchically; PM [01], BFM [02],[3]-[11].	02-01-00-001-07-28-16
5	PMP, Configuration plan, quality assistance plan, and risk management plan identified as part of PMP.	02-01-00-001-07-28-16
6	The [01] Requirements Management (REQM) Plan documents project requirements.	02-01-00-001-07-28-16
7	REQM Project processes for interpretation, agreement, and commitment to management and technical requirements.	02-01-00-001-07-28-16
8	Project approach to requirements documentation, traceability, and addressing changes.	02-01-00-001-07-28-16
9	Reviews and other mechanisms to ensure that inconsistencies between requirements, project plans, and work products are identified, tracked, and resolved.	02-01-00-001-07-28-16
10	The project schedule baseline is captured in Appendix B and will be updated on a weekly basis, or as necessary to reflect current data. In order to maintain an efficient project schedule.	02-01-00-001-07-28-16
11	Task duration will be no less than 1 week (40 hours) for any project with a weekly update requirement.	02-01-00-001-07-28-16
12	No task will extend beyond 44 days (2 months) as this will cause a loss of fidelity in the project schedule.	02-01-00-001-07-28-16
13	Level of Effort tasks (such as Project Management, Acquisition Management, and Financial Management) will not be applied to the project schedule.	02-01-00-001-07-28-16
14	Cost will be captured and managed via numerous tools:	02-01-00-001-07-28-16
15	Reimbursable cost will be managed via N-ERP.	02-01-00-001-07-28-16
16	Direct Cite cost will be managed via Monthly Status Reports (MSRs) from sub-contractors and Wide Area Workflow (WAW).	02-01-00-001-07-28-16
17	Overall cost performance will be monitored via the appropriate Earned Value Management (EVM) metrics and variances.	02-01-00-001-07-28-16
18	The [01] Quality Assurance (QA) Plan documents the QA management activities that are in place throughout the project life cycle to attain satisfaction of project quality objectives and requirements. By ensuring that staff and management have objective insight into project process performance and implementation of evolving work products and services, necessary corrective action can be taken in a timely manner to prevent significant project impacts. Also, collection of project process-related experiences and key artifacts can help to improve the commands set of organizational standard processes.	02-01-00-001-07-28-16

**Table 56: C2 Evidence Items from the Case Study Database (Portion)**

The case evidence showed the task leads routinely gathering for meetings and discussing operational requirements. The use of the Integrated Master Schedule (IMS) that was hosted by the sponsor demonstrated the organization interaction and accountability of each of the tasks within the project. The Project lead oversaw the operational milestones and metric developments of the individual task in support of the sponsor's requirements. The evidence supports the presence of C2 channels as defined by the VSM.

### **CHANNEL THREE DEVELOPMENT FROM THE CSR DATABASE**

Analyzing for elements of Channel Three, the researcher looked for communication primarily between the S3's and S1's. This provided project updates and examined the communications which helped define the management style used within this channel. The task leads had discussions concerning their task at the weekly minutes, with minutes recorded and distributed. The task leads had group meetings with their team and daily working discussions that helped capture the data for reporting. The weekly meeting format was used to brief all on the project team members. Often the discussions of an ongoing task were discussed with the sponsor, project lead, and the task leads concurrently. The S3 provided the task leads insight into the organization culture and decision making ongoing within the support areas of the organization; for example, contracts areas, management's project priorities, submission deadlines, training opportunities, etc. The task leads would provide status reports and metrics to be used by management. The case study database was analyzed for themes that would support the presence of C3's in this case. The following case study data supports the presence of the C3's shown in Table 57 below:

Item	Evidence Description	Data Source Code
2	The project supports ISEA services, JITC testing, overall engineering and support for [01] (and anything related) [02].	02-01-00-001-07-28-16
4	Project team identified hierarchically; PM [01], BFM [02],[3]-[11].	02-01-00-001-07-28-16
5	PMP, Configuration plan, quality assistance plan, and risk management plan identified as part of PMP.	02-01-00-001-07-28-16
6	The [01] Requirements Management (REQM) Plan documents project requirements.	02-01-00-001-07-28-16
7	REQM Project processes for interpretation, agreement, and commitment to management and technical requirements.	02-01-00-001-07-28-16
8	Project approach to requirements documentation, traceability, and addressing changes.	02-01-00-001-07-28-16
9	Reviews and other mechanisms to ensure that inconsistencies between requirements, project plans, and work products are identified, tracked, and resolved.	02-01-00-001-07-28-16
10	The project schedule baseline is captured in Appendix B and will be updated on a weekly basis, or as necessary to reflect current data. In order to maintain an efficient project schedule.	02-01-00-001-07-28-16
11	Task duration will be no less than 1 week (40 hours) for any project with a weekly update requirement.	02-01-00-001-07-28-16
12	No task will extend beyond 44 days (2 months) as this will cause a loss of fidelity in the project schedule.	02-01-00-001-07-28-16
13	Level of Effort tasks (such as Project Management, Acquisition Management, and Financial Management) will not be applied to the project schedule.	02-01-00-001-07-28-16
14	Cost will be captured and managed via numerous tools:	02-01-00-001-07-28-16
15	Reimbursable cost will be managed via N-ERP.	02-01-00-001-07-28-16
16	Direct Cite cost will be managed via Monthly Status Reports (MSRs) from sub-contractors and Wide Area Workflow (WAW).	02-01-00-001-07-28-16
17	Overall cost performance will be monitored via the appropriate Earned Value Management (EVM) metrics and variances.	02-01-00-001-07-28-16

**Table 57: C3 Evidence Items from the Case Study Database (Portion)**

The evidence shows the team regularly met with other team members to bargain for resources. The project had multiple tasks that relied on the skillsets of the overall team. The project lead oversaw the bargaining of resources to ensure that the tasks remained within scope.

Deviation that was required meant the project lead had to renegotiate with the sponsor for funding or realigning funded requirements. The evidence supports the presence of C3 channels as defined by the VSM.

#### **CHANNEL FOUR DEVELOPMENT FROM THE CSR DATABASE**

Analyzing for elements of Channel Four, the researcher looked for areas where resource bargaining occurred between the S1's and S3's. With changes in schedule frequent, the need for resources and the availability of resources changed. The project lead identified the lack of resources available to the multiple projects. The lack of skillset available to the project from the organization was identified and understood by the sponsor. The S1's informed the S3's to ensure S5 knew what resources were needed and the impact to the individual tasks. The bargaining and sharing of resources was a regular event for the tasks during their weekly meetings. The case study database was analyzed for themes that would support the presence of C4's in this case. The following case study data supports the presence of the C4's shown in Table 58:

Item	Evidence Description	Data Source Code
18	The [01] Quality Assurance (QA) Plan documents the QA management activities that are in place throughout the project life cycle to attain satisfaction of project quality objectives and requirements. By ensuring that staff and management have objective insight into project process performance and implementation of evolving work products and services, necessary corrective action can be taken in a timely manner to prevent significant project impacts. Also, collection of project process-related experiences and key artifacts can help to improve the commands set of organizational standard processes.	02-01-00-001-07-28-16
19	The IPT Lead is responsible for ensuring proper communication and stakeholder engagement in the [01] IPT. This includes identifying, communicating, and coordinating with the relevant stakeholders listed in this PMP who participate in, or are affected by specific IPT activities. The IPT Lead is responsible for developing a comprehensive plan that outlines the appropriate timing and messaging for engaging stakeholders in key decisions, activities, and development milestones. This is dependent upon a thorough stakeholder identification and analysis of their roles and responsibilities, interests, and any potential for obstacles or resistance.	02-01-00-001-07-28-16
35	Command IA Compliance: Details: IA lead is responsible for providing technical judgment of the system's compliance with stated requirements, identifying and assessing the risks associated with operating the systems for various fielded [01] products. Deliverables: - Conduct oversight and analyses of required IAVA/B patch management for fielded [01] accredited systems; FISMA Reviews and Updates; IA Package Reviews/Updates (Risk Management Framework (RMF)); Support/review Engineering Change Request (ECR) activities;VRAM Compliance Reporting	02-01-00-003-07-28-16
36	Command IA Compliance Details: Augment Govt IA activities. Support is provided for various [01] products.	02-01-00-003-07-28-16
37	Command ISEA Lead: Details: ISEA Lead oversees all ISEA related activities for fielded [01] systems ensuring they are planned and executed as required. Deliverables: ULSS Package Creation/Reviews/Updates; SOVT Development/Review -Site Support/Assistance; ISEA Spare Procurement; Logistics Support; Shipping/Receiving/Warehouse Storage	02-01-00-003-07-28-16
38	Command ISEA Remedy Help Desk: Details: Monitor, update, open, analyze, prioritize trouble tickets. Continue to monitor, analyze, and revise any current processes documents associated with efforts. Deliverables: Quarterly Metric Reports (Trouble Tickets, CASREPS); Technical Assistance/Help Desk Support; Ensure Command Remedy database for maintenance actions are documented and updated weekly; Review and approve monthly reports summarizing support actions conducted and documented within Remedy and SAILOR	02-01-00-003-07-28-16
39	Command ISEA Remedy Help Desk: Details: Monitor, update, open, analyze, prioritize trouble tickets. Continue to monitor, analyze, and revise any current processes documents associated with efforts. Deliverables: - Quarterly Metric Reports (Trouble Ticket: Details: Augment Govt Remedy Help Desk efforts	02-01-00-003-07-28-16
40	Command Fleet Support: Details: Provide Fleet Support, Distant Support, On-site assistance. Monthly review of trouble tickets, CASREPS, general system issues. Deliverables: CASREP reporting; Trip Reports (as applicable)	02-01-00-003-07-28-16
41	Enterprise Licenses: Details: Augment Govt Fleet Support activities, Distant Support, On-site assistance.	02-01-00-003-07-28-16
42	Command Laboratory: ELA Cost (Cisco, Microsoft, VMWare): Details: Fee for customer circuit connectivity for testing with command [01]	02-01-00-003-07-28-16
43	Command Windows 10 Implementation: Replace Windows 7 clients with a customer Windows 10.	02-01-00-003-07-28-16
44	Program office and project team in meeting with other stakeholders; discussed project issues; contract items; scheduled items and changes/updates; documentation updates; open action items discussed.	02-01-00-004-07-28-16

**Table 58: C4 Evidence from the Case Study Database (Portion)**

The evidence showed the need for resources for multiple tasks coming in from the Help Desk. This need was presented in the weekly meetings. The weekly meetings provided the venue for the bargaining for resources often occurring to ensure the project lead was always aware of the task leads needs and negotiation of decisions on resources. The evidence supports the presence of C4 channels as defined by the VSM.

**CHANNEL FIVE DEVELOPMENT FROM THE CSR DATABASE**

Analyzing for elements of Channel Five, the researcher looked for areas where S2's functional areas were working to reduce conflicts and other project level oscillations. The presentation of schedules and baselines (IMS) helped to ensure all the task members were aware of where the resources were initially planned. Conflicts or changes that affected another task were often brought up early and mitigated primarily in weekly meetings. The case study database was analyzed for themes that would support the presence of C5's in this case. The following case study data supports the presence of the C5's shown in Table 59:



Item	Evidence Description	Data Source Code
18	The [01] Quality Assurance (QA) Plan documents the QA management activities that are in place throughout the project life cycle to attain satisfaction of project quality objectives and requirements. By ensuring that staff and management have objective insight into project process performance and implementation of evolving work products and services, necessary corrective action can be taken in a timely manner to prevent significant project impacts. Also, collection of project process-related experiences and key artifacts can help to improve the commands set of organizational standard processes.	02-01-00-001-07-28-16
19	The IPT Lead is responsible for ensuring proper communication and stakeholder engagement in the [01] IPT. This includes identifying, communicating, and coordinating with the relevant stakeholders listed in this PMP who participate in, or are affected by specific IPT activities. The IPT Lead is responsible for developing a comprehensive plan that outlines the appropriate timing and messaging for engaging stakeholders in key decisions, activities, and development milestones. This is dependent upon a thorough stakeholder identification and analysis of their roles and responsibilities, interests, and any potential for obstacles or resistance.	02-01-00-001-07-28-16
35	Command IA Compliance: Details: IA lead is responsible for providing technical judgment of the system's compliance with stated requirements, identifying and assessing the risks associated with operating the systems for various fielded [01] products. Deliverables: - Conduct oversight and analyses of required IAVA/B patch management for fielded [01] accredited systems; FISMA Reviews and Updates; IA Package Reviews/Updates (Risk Management Framework (RMF)); Support/review Engineering Change Request (ECR) activities;VRAM Compliance Reporting	02-01-00-003-07-28-16
36	Command IA Compliance Details: Augment Govt IA activities. Support is provided for various [01] products.	02-01-00-003-07-28-16
37	Command ISEA Lead: Details: ISEA Lead oversees all ISEA related activities for fielded [01] systems ensuring they are planned and executed as required. Deliverables: ULSS Package Creation/Reviews/Updates; SOVT Development/Review -Site Support/Assistance; ISEA Spare Procurement; Logistics Support; Shipping/Receiving/Warehouse Storage	02-01-00-003-07-28-16
38	Command ISEA Remedy Help Desk: Details: Monitor, update, open, analyze, prioritize trouble tickets. Continue to monitor, analyze, and revise any current processes documents associated with efforts. Deliverables: Quarterly Metric Reports (Trouble Tickets, CASREPS); Technical Assistance/Help Desk Support; Ensure Command Remedy database for maintenance actions are documented and updated weekly; Review and approve monthly reports summarizing support actions conducted and documented within Remedy and SAILOR	02-01-00-003-07-28-16
39	Command ISEA Remedy Help Desk: Details: Monitor, update, open, analyze, prioritize trouble tickets. Continue to monitor, analyze, and revise any current processes documents associated with efforts. Deliverables: - Quarterly Metric Reports (Trouble Ticket: Details: Augment Govt Remedy Help Desk efforts	02-01-00-003-07-28-16

**Table 59: Evidence from the Case Study Database (Portion)**

The potential for oscillation between the various tasks existed due to a shortage of resources. The project lead, task leads, and sponsors recognized this and it was the focus of weekly meetings. The project team worked from the sponsors IMS to ensure all team members were aware of the overall schedule. This consistent discussion and communication between the team members was needed to manage project resources.

### **CHANNEL SIX DEVELOPMENT FROM THE CSR DATABASE**

Analyzing for elements of Channel Six, the researcher looked for areas for which the project was monitored and controlled. A significant area again was during the weekly meetings. Formal audits were conducted during a Program Management Review (PMR). Internal audits of the IPT (a layer above the project team) and projects occurred (but not during this study). The project was reviewed using the reviewers predetermined checklists. The project lead, task lead, and BFM were primary entities involved in these types of audits. The case study database was analyzed for themes that would support the presence of C6's in this case. The following case study data supports the presence of the C6's shown in Table 60:

Item	Evidence Description	Data Source Code
1	The project supports [02].	02-01-00-001-07-28-16
4	Project team identified hierarchically; PM [01], BFM [02],[3]-[11].	02-01-00-001-07-28-16
5	PMP, Configuration plan, quality assistance plan, and risk management plan identified as part of PMP.	02-01-00-001-07-28-16
6	The [01] Requirements Management (REQM) Plan documents project requirements.	02-01-00-001-07-28-16
7	REQM Project processes for interpretation, agreement, and commitment to management and technical requirements.	02-01-00-001-07-28-16
8	Project approach to requirements documentation, traceability, and addressing changes.	02-01-00-001-07-28-16
9	Reviews and other mechanisms to ensure that inconsistencies between requirements, project plans, and work products are identified, tracked, and resolved.	02-01-00-001-07-28-16
10	The project schedule baseline is captured in Appendix B and will be updated on a weekly basis, or as necessary to reflect current data. In order to maintain an efficient project schedule.	02-01-00-001-07-28-16
11	Task duration will be no less than 1 week (40 hours) for any project with a weekly update requirement.	02-01-00-001-07-28-16
12	No task will extend beyond 44 days (2 months) as this will cause a loss of fidelity in the project schedule.	02-01-00-001-07-28-16

**Table 60: C6 Evidence from Case Study Database (Portion)**

The PMRs and internal audits were the prime area for monitoring and control. The project leads participation and monitoring of status and reports updates during weekly meetings demonstrates further monitoring and control of the project and the associated tasks. The project leads monitor of financial reports with the BFM is another example. The project and task leads observation of ongoing tasks by walking around and inspecting the progress of ongoing work demonstrated monitoring of the project. The evidence supports the presence of C6 channels as defined by the VSM.

## **CHANNEL ALGEDONIC DEVELOPMENT FROM THE CSR DATABASE**

The algedonic channel was not very clear as the metasystem of S3, S4, and S5 were difficult to distinguish. In government organizations like this, and for this project, it was understood the project lead be held accountable for all aspects of a project. Sponsors, external stakeholders, internal support competencies, and management alike often targeted the project lead not only for problems but for data calls. Often data calls appeared to be treated as problems as they were the defense for the situation of concern. There was a channel that existed directly to the top: to the project lead.

## **PROJECT 'T' CASE STUDY SUMMARY**

The adapted VSM model analysis of Project 'T' indicated it could be mapped into the VSM. As the VSM looks at viability verses optimization, for example, it can be seen that the S3, S4, and S5 appear to collapse together, perhaps due to a weakly defined S4. The six primarily communication channels existed within this project.

Project 'T' was modeled with the VSM where the S1's are defined below:

1. Fleet Support/ISEA
2. IP Trunking
3. RTMS
4. TUMS
5. VoSIP
6. VTCoSIP
7. VCS Expressway

8. NVCS

9. Aegis Ashore

10. Government oversight of Telephony Tasks

The S5 function was predominately performed by the project lead, task leads, and BFM lead. The task leads of S1 worked with the project lead in the S3 functional role along with BFM lead. The S4 functional role was weak and difficult to distinguish as it appeared to be rolled up into S3 and S5 type functions. An effort was made to separate the S4 functional area. The communication channel development for the project focused on the six primary channels. All channels had representative links that would be expected in the VSM. This project at a minimum did contain all the elements needed for a project that would be modeled by the VSM and is illustrated below in Figure 31:

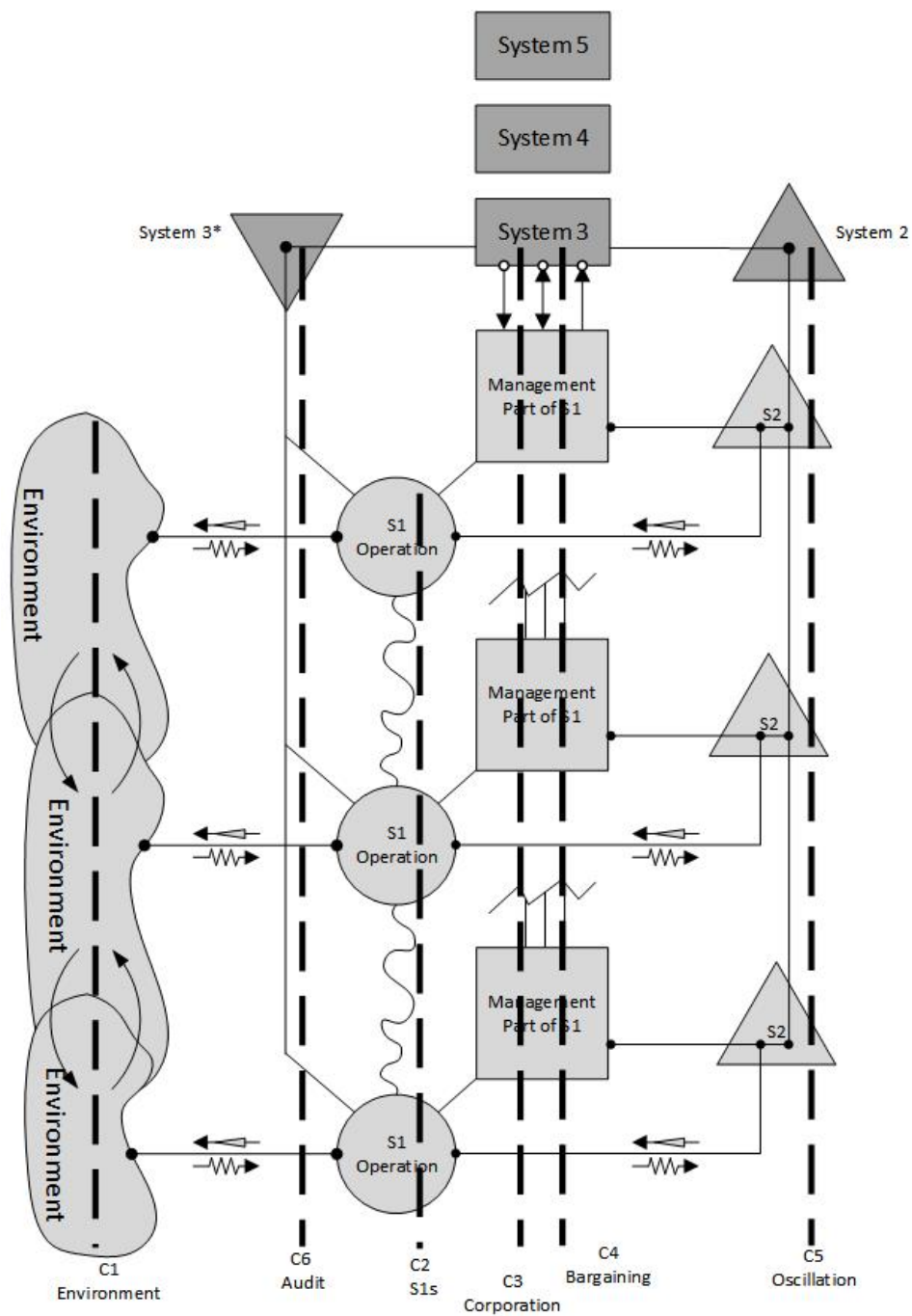

Figure 31: VSM of Project (Systems and Channels are Described in the Case Narrative)

In reviewing this project data, the systems and six primary channels did appear to meet at least minimum requirements in all areas. The S3-S4-S5 metasystem was seen to be more condensed into one system, but still met the minimal requirements by definition. The strategic functional area of the S4 was most notably not clearly defined. A separate functional area was deemed impractical due to the workload and emphasis was not placed in this area. This was reflected in minimal discussion of strategic initiatives, etc. PMBOK (2013) notes without this functional area the link between the organization and the project team will lose this strategic element.

### **PROJECT 'T' CASE STUDY CONCLUSION**

The case study narrative was developed from data collected from operational phase of a government engineering project. The project was analyzed using the VSM developed by Stafford Beer (1981) for use with organizational modelling and refined for use with this case study. The case study narrative was drafted in a structure that utilized the system and channels that were developed from the conceptual framework for data analysis.

The systems and six primary channels met at least minimum requirements to support the ability to model project structure with all areas specified by the VSM. The S3-S4-S5 metasystem was seen to be more condensed into one system, but still met the minimal requirements of the VSM by definition. A separate strategic functional area was deemed impractical due to the work load and emphasis was not placed in this area. This was reflected in minimal discussion of strategic initiatives, etc. PMBOK (2013) notes without this functional area the link between the organization and the project team will lose this strategic element. The six primarily

communication channels existed with this project. The supporting evidence items from the case study database linked the evidence to the definition of the Systems and Channels of the VSM.

One of the research questions for this study concerned how the Viable System Model (VSM) can be adapted for analysis of project management structure. To be appropriate for case study research, data analyzed using the conceptual framework would have to be capable of being used to develop an accurate case narrative.

The case narrative was drafted and copies were distributed to the IPT Lead and participating Project 'T' team members. The project team was asked to make any corrections or comments that they deemed appropriate and provide written feedback. Copies of the draft case study narrative for Project 'T' are exhibited in Appendix 1. Comments and corrections for the draft case study narrative for Project 'T' are exhibited in Appendix 4. Review of the corrections and comments indicated no substantial inaccuracies noted in the reviewer's comments. The minor corrections and comments noted were corrected in the edition presented. Grammatical and typographical errors which were noted were also corrected. The fact that there were few inaccuracies reported is evidence that the narrative reflects the model's accurately depicting the project team's view of the project management structure of Project 'T'. The project team's reflection served to verify that the data used to produce the narrative was accurate and is evidence that the conceptual framework used in the data analysis was appropriate for the system being studied and the case study research method that was used.



## CROSS CASE ANALYSIS

### INTRODUCTION

The purpose of the cross case analysis is to compare the two case studies for this research effort. The research was completed as a multiple case study. Each case study can stand alone but much can be realized by comparing the systems and channels assessed across the two projects.

As with the data analysis, the conceptual framework used to conduct the cross case analysis was based on the VSM and how it can support analysis of project management structures. The cross case analysis and interpretations were drawn from the comparative interpretation of similarities and differences in the case narratives and associated case study databases. Also, the analysis was based on the data supported interpretations of the researcher. The source code used for this research effort is defined in Appendix 9 and shown below for convenience:

The Source code from left-to-right (xx-xx-xx-xxx-xx-xx-xx) is defined as below:

Evidence number = xx-xx-xx-xxx-xx-xx-xx

xx - The project the data is associated with for example:

1. '01' is Project 'Q'
2. '02' is Project 'T'

xx - The type of data source, for example:

1. '00' Document from email
2. '01' Meeting
3. '02' Discussion
4. '03' Observation

xx - Who/the source; the person or project name; used to protect identity for anonymity.

xxx - Artifact Number, Data Source Item.

xx-xx-xx - Last six are the date based on two digit month-day-year

When describing an evidence item in the case narratives, the nomenclature is EI-(#, #, etc.) where EI = Evidence Item and # = number. Project Q = PQ and Project T = PT. For example, two evidence items 35 and 43 from the Project Q database would be represented as:

PQ:EI-[35,43]

The following sections examine the two case narratives. The sections compare and contrast the systems and primary communication channels identified from the cross case analysis. Results are summarized at the end of each section.

## **SYSTEM ONE – CROSS CASE REVIEW**

This section presents the findings of what the VSM shows as the similarities and differences between the Systems One functions within the two case studies. Similarities of System One functions are discussed first followed by their differences. The section concludes with a tabular overview of System One results.

The primary System One functions of the two projects were identified in the tasking documents the sponsor had funded and provided to the project teams. The tasks and associated funding were clearly defined and agreed to by each of the two project team leads, BFM's, sponsors, and associated organizational support. The project leads of both project teams worked with the task leads to identify their individual team tasks and ensured monitoring and control of

the performance of the individual tasks, in relation to the overall project, was accomplished at the task level.

The level of oversight was different between the projects. Project 'T' often had combined meetings with the sponsor with multiple task members present. The meetings occurred more frequently in comparison to Project 'Q'. Project 'Q' had project level technical discussions during their group meetings, spawned by potential foreseen conflicts, illustrated in Evidence Item (EI) [5]. In this example a safety issue was identified with a previously installed system. The issue was conflicting with current task effort, but concurrently an effort to secure future tasking could be affected without the system fix. Work schedules for Project 'Q' changed due to customer accessibility or resources conflicts within the team. This was a reportable item to the sponsor, but the sponsor was never seen dictating the schedule. Conversely, Project 'T' appeared to work from the sponsor's master schedule. The effects of the sponsor's inputs to the resourcing balancing efforts were seen to be affected by the sponsor in Project 'T'. Project 'Q' task meetings focused more on providing team updates as from Evidence Items (EI) [37-51] verses issues and schedule changes that were discussed during Project 'T' task meetings, as Evidence Items [82-86] indicate. Because of the Project 'T's' reliance on the sponsor for schedule changes and resource balancing at the task level, Project 'T' can be said to be less autonomous than Project 'Q' in terms of System One functional identifiers.

Table 61 below shows the similarities and differences that the VSM was able to highlight during the cross case analysis of the two case study narratives:

Similarities	Differences
Tasking identified in sponsor's tasking statements.	Project 'T' task lead meetings were combined with project lead and other task leads meetings with sponsor; whereas Project 'Q' had individual task meetings and group meetings.
Task leads strive to promote organization PM processes.	Project 'T' project lead met with all task leads and typically the sponsor was included to provide guidance.
	Project 'Q' lead met with task leads separately.
	Project 'Q' had strategic discussion ad hoc during group meetings; Project 'T' did not have strategic meetings.
	Project 'T' worked off the sponsor's master schedule; whereas Project 'Q' maintained an autonomous schedule and provided updates to the sponsor.
	Project 'T' meetings focused on overall issues and change; where Project 'Q' task meetings focused on updating the group.
	Project 'Q' task S1 functional group was more autonomous than Project 'T's task groups.

**Table 61: System One Similarities and Differences Summarized**

Although the two project teams handled System One's functions differently, this does not diminish the fact that the VSM was able to model the task level actions of the project in the System One domain. The VSM does not optimize the project but rather requires a minimum number of systems and communication channels to be present and be defined by the models criteria. For both cases, although achieved by different means, the System One function was achieved and was capable of being identified using the VSM framework for analysis of project management structure.

## SYSTEM TWO – CROSS CASE REVIEW

This section presents the findings of what the VSM shows as the similarities and differences between the Systems Two functions within the two case studies. Similarities of System Two functions are discussed first followed by their differences. The section concludes with a tabular overview of System Two results.

A similarity of S2 functions between projects ‘Q’ and ‘T’ was the fact that communication channels between the S3 functional area (where the project leads perform their management functions) and S1 (where the task leads performed management function existed). Disagreements related to S1 resources were discussed and resolved for both projects. Initial estimates and plans established the resources allocations. When re-prioritization of tasks occurred (Project ‘T’ in particular), team meetings were able to reschedule and redirect resources to meet the new timeline requirements (PT: EI-[18, 48, and 60] support this assertion). Similarly, the planned meetings and definition of the individual tasks under the guidance of the PMP helped ensure the individual task leads were able to maintain their autonomy and understand the resources allocated to each project and associated task areas (PT: EI-[1-26] and PQ: EI-[164-173]).

Project ‘Q’ was different in handling System Two functions than Project ‘T’ as seen from the task meetings. During Project ‘Q’s task meetings, the sponsor or at times even the project lead were not present (PQ: EI-[1-19]). Project ‘Q’ task leads were able to discuss and manage resources at this lower level. During Project ‘T’ task meetings, sponsors and the project leads were often discussed and facilitated resources changes between the individual tasks (PT: EI-[84-97]). Task leads in Project ‘Q’ did not appear to have a separate time to discuss resource

reallocation other than during the group meeting. Project 'Q' better represented what would be expected in a VSM of PMS in this S2 functional area.

Table 62 below shows the similarities and differences that the VSM was able to highlight during the cross case analysis of the two case study narratives:

Similarities	Differences
Channels between the task leads existed for resource oscillatory discussions.	Project 'Q' handled anti-oscillatory concerns of task resources between the task leads.
PMP for each project defined a process to perform S2 functional man agent processes.	Project 'T' handled anti-oscillatory concerns of task resources with the task lead, sponsors, and project lead present. The entire project management team was involved during the discussion.

**Table 62: System Two Similarities and Differences Summarized**

Although the two project teams handled System Two's functions differently, this does not diminish the fact that the VSM was able to model the task level actions of the project in the System Two domain. For both cases, although achieved by different means, the System Two function was achieved and was capable of being identified using the VSM framework for analysis of project management structure.

### **SYSTEM THREE – CROSS CASE REVIEW**

This section presents the findings of what the VSM shows as the similarities and differences between the Systems Three functions within the two case studies. Similarities of

System Three functions are discussed first followed by their differences. The section concludes with a tabular overview of System Three results.

The primary System Three functions of the two projects were performed by the task leads, working with the project lead, the BFM, and contractor team lead. Similar functional areas within the System Three task for both projects were seen to occur during weekly meetings, government oversight functions, and contract negotiations (PQ: EI-[48, 50, 55, 109]; PT:EI-[1-24, 58-70,81-91]). The 'here-and-now' (Beer, 1981) of the current tasking and associated schedules were discussed. Resources were identified, tracked, and reported during these System Three level meetings and the information was then processed for distribution amongst the task leads and their team members, usually sent via email (PQ: EI-[48, 50, 55, 109]; PT: EI-[1-24, 58-70,81-91]).

An apparent difference between Projects 'Q' and 'T' is the level of autonomy of the System Three managerial function. Project 'Q' best mirrors what would be expected from a VSM perspective whereas Project 'T' blends the project lead, task lead, and to a certain extent the sponsor in the S3 with respect to the way policies and procures are passed to the project teams. Similarly, Project 'T' exhibits a meshing of information flow around the mentioned management team verses a flow through the S1-S3-S4-S5 that would be expected based on a VSM view. Goals, resource negotiating, and accounting procedures are different between the projects. Each of the two projects references the use of a PMP (PQ: EI-[164-178; PT: EI-[1-33]) to manage the previous functions; however, during the group meetings of Project 'T', procedures (goals, resource negotiating, and accounting) mentioned are changed based on sponsor requests (PT: EI – [59,91-93]). Change request on procedures were not challenged by the Project 'T' and

represented a deviation from the project's own PMP (PT: EI – [59, 91-93]). Similarly, S5 functional lead provided direct interpretations and implementations of policy, verses a mitigation through a S3 functional area as was done with Project 'Q'.

Table 63 below shows the similarities and differences that the VSM was able to highlight during the cross case analysis of the two case study narratives:

Similarities	Differences
Weekly meetings to deliver policies, government oversight, resource negotiation updates.	Project 'Q' best fit the VSM model's expectation; Project 'T' was less autonomous at the S3 functional level as managerial function of S4-S5 were blended reducing the clarity of the S3 role within Project 'T'.
	Routine information expected flow to the S1's from the S3's is offset by S5 and sponsor involvements.
	S3 managerial process within Project 'T' deviate from PMP processes due to outside influence.

**Table 63: System Three Similarities and Differences Summarized**

Although the two project teams handled System Three's functions differently, this does not diminish the fact that the VSM was able to model the task level actions of the project in the System Three domain. For both cases, although achieved by different means, the System Three function was achieved and was capable of being identified using the VSM framework for analysis of project management structure.



### **SYSTEM THREE \* (STAR) – CROSS CASE REVIEW**

This section presents the findings of what the VSM shows as the similarities and differences between the Systems Three \* (Star) functions within the two case studies. Similarities of System Three \* (Star) functions are discussed first followed by their differences. The section concludes with a tabular overview of System Three \* (Star) results.

The primary System Three \* (Star) functions of the two projects were identified as being responsible for the internal and immediate functions of the organization. While System Three provides the 'here-and-now' and the 'day-to-day' management within an organization System Three\* (Star) provides for the audit of these functions (Beer, 1985, p. 86). System Three\* (Star)'s are a part of System Three and "are not separable from Three itself, except for the fact that they operate – by consensus – APART from the command function" (Beer, 1985, p. 86). Similarities in the System Three \* (Star) functions include the fact that each project has scheduled Program Management Reviews (PMR) with their associated sponsors (PQ: EI-[107]; PT: EI-[124]. Each PMP addresses the audit process and each PMP is based off the same organizational PMP template. Both projects are also subject to internal organizational reviews and audits.

Although not a major difference, each project has a different sponsor and hence the expectations of the project level audit presented during PMRs are different. The level of criticality of expectations can vary greatly between project sponsors. The organization, in an effort to ensure each project maintains a standard expected within the organization, performs its own reviews to mitigate these risks. Also, change is the norm in Project 'T' verses Project 'Q'

(PT: EI-[87-93]; hence, during meetings change is expected in Project 'T' whereas in Project 'Q' it is a warning sign of a deviation from planned events and taken more seriously.

Table 64 below shows the similarities and differences that the VSM was able to highlight during the cross case analysis of the two case study narratives:

Similarities	Differences
Each project has scheduled Project Management Reviews (PMR).	Although not a major difference, each project has a different sponsor and hence the expectations of the project level audit presented during PMRs are different.
Each has a PMP that addresses the audit process.	Change is the norm in Project 'T' versus Project 'Q'; hence during meetings it is expected and not critique in Project 'T' whereas in Project 'Q' it is a warning sign of a deviation from planned events; hence taken more seriously.
Both projects are subject to internal organizational audits.	

**Table 64: System Three \* (Star) Similarities and Differences Summarized**

Although the two project teams handled System Three \* (Star)'s functions differently, this does not diminish the fact that the VSM was able to model the task level actions of the project in the System Three\* (Star) domain. For both cases, although achieved by different means, the System Three \* (Star) function was achieved and was capable of being identified using the VSM framework for analysis of project management structure.

## **SYSTEM FOUR – CROSS CASE REVIEW**

This section presents the findings of what the VSM shows as the similarities and differences between the Systems Four functions within the two case studies. Similarities of System Four functions are discussed first followed by their differences. The primary System Four functions of the two projects were represented by the structures put in place to monitor the environment and the organization itself to ensure it is able to remain viable. System Four is concerned with the management of the ‘outside-and-then’ and works to provide self-awareness for the System-in-Focus (Beer, 1985). System Four interfaces with System Five, the ultimate authority. The section concludes with a tabular overview of System Four results.

In both projects, the S4 functional areas were difficult to discern. Project ‘Q’ would have specific strategic meetings/discussions that were more informal in nature as no schedule meeting times or meeting minutes were available for review (that discussed S4 functions specifically). Project ‘T’, a project lacking resources (PT: EI-83-93]) to accomplish all the desired tasking the sponsor has, was challenged to meet the current work load. Looking strategically, especially for additional work, was not seen as an issue and was reflected in no strategic functional areas discussions within the team (PT: EI-[83-93]). When asked, the project lead did have discussions with the sponsor on strategic efforts, but this was seen as informal and not documented (PT: EI-[83-93]).

Each project appears to have a collapsing S3-S4-S5 area, the difference being that Project ‘Q’ appeared to be aware of the need for a S4 functional area and made attempts to facilitate S4 functions (PQ : EI-[96]; whereas the Project ‘T’ collapse of the S3-S4-S5 was more pronounced.

Table 65 below shows the similarities and differences that the VSM was able to highlight during the cross case analysis of the two case study narratives:

Similarities	Differences
Weak S4 area, both appear to be in a collapsed state.	Project 'Q' had a stronger appearance of a S4 presence than Project 'T'.
No evidence found to show project modeling of past/present/future efforts	
Both align and are of aware of sponsor's vision.	
No evidence of environmental scanning.	
Maintains equipment/system configurations for logistics purposes.	

**Table 65: System Four Similarities and Differences Summarized**

Although the two project teams handled System Four's functions differently, this does not diminish the fact that the VSM was able to model the task level actions of the project in the System Four domain. For both cases, although achieved by different means, the System Four function was achieved and was capable of being identified using the VSM framework for analysis of project management structure.

## **SYSTEM FIVE – CROSS CASE REVIEW**

This section presents the findings of what the VSM shows as the similarities and differences between the Systems Five functions within the two case studies. The primary System Five functions of the two projects centered on the project lead and the BFM which had final

negotiating authority over the tasking the project accepted. Similarities of System Five functions are discussed first followed by their differences.

The project lead maintained the final authority for project related decisions within the organization and also was responsible for all the processes, data calls, and organizational procedures that were mandated by the organization. Both of the projects were autonomous, but not purely. Organizational management requirements occurred and were passed down to the team (PQ: EI-[8-51, 61, 62, 99-101, 147,164-176,184]; PT: EI-[1-32, 43-50, 56, 66, 70, 84, and 105]). The projects are clearly defined by their tasking from each of their sponsors and articulated to the organization by the project's respective leads (PQ: EI-[8-51, 61, 62, 99-101, 147,164-176,184]; PT: EI-[1-32, 43-50, 56, 66, 70, 84, and 105]). The project leads are ultimately responsible for the project and the associated tasks; recognized by organization, environment, and associated task leads. Both projects are weak in developing system policy for their projects, strategic planning, and interacting within the S3-S4-S5 domain (PQ: EI-[8-51, 61, 62, 99-101, 147,164-176,184]; PT: EI-[1-32, 43-50, 56, 66, 70, 84, and 105]).

The S5 functional area differences were difficult to discern. It can be said that Project 'Q' represented the S5 functional area better than Project 'T' particularly in the area of addressing the collapse in the S3-S4-S5 area.

Table 66 below shows the similarities and differences that the VSM was able to highlight during the cross case analysis of the two case study narratives:

Similarities	Differences
Project Lead ultimately responsible for the project and associated tasks.	Minimal differences.
Maintained an identity recognized by all stakeholders.	Project 'Q' had a stronger S3-S4-S5 functional area, but still weak in terms of functional separation as both projects exhibited signs of collapse.
Looked at the needs of their individual projects.	
Worked to have overall view of their projects.	

**Table 66: System Five Similarities and Differences Summarized**

Although the two project teams handled System Five's functions differently, this does not diminish the fact that the VSM was able to model the task level actions of the project in the System Five domain. For both cases, although achieved by different means, the System Five function was performed and was capable of being identified using the VSM framework for analysis of project management structure.

The above gave the cross case analysis of the associated Systems functions of the VSM. The communication channels that exist between the Systems and the environments are presented in the following paragraph.

### **CHANNEL ONE – CROSS CASE REVIEW**

This section presents the findings of what the VSM shows as the similarities and differences between the Channel One functions within the two case studies. Similarities of Channel One functions are discussed first followed by their differences. The primary Channel One functions of the two projects were identified as connecting and absorbing variety between

the environments of each identified operational unit. An example of this was found where the same contractor received tasking from two different task leads with specific product/service output requirements (PQ: EI-[75, 76, 84, 86, 108-111]; PT: EI-{36-39, 48, 63-65, 89}). The task leads from the S1 worked with the same contractor team to get their tasks completed. The purchase of material for two different tasks from the same vendor is another example of this communication between the environmental units to members of the project team (PQ: EI-[75, 76, 84, 86, 108-111]; PT: EI-{36-39, 48, 63-65, 89}).

Also similar, each project used technical contractors to supplement the project teams. Support contractors supporting one task were known to communicate with other contractors supporting other task leads within the project; or were from the same company (PQ: EI-[75, 76, 84, 86, 108-111]; PT: EI-{36-39, 48, 63-65, 89}).

No significant differences within the C1 channel were noted. The section concludes with a tabular overview of Channel One results. Table 67 below shows the similarities and differences that the VSM was able to highlight during the cross case analysis of the two case study narratives:

Similarities	Differences
Each used technical based contractors to supplement the project teams.	No specific differences noted.
Support contractors supporting one task were known to communicate with other contractors supporting other task leads within the project; or were from the same company.	

**Table 67: Channel One Similarities and Differences Summarized**

Although the two project teams handled System Three's functions differently, this does not diminish the fact that the VSM was able to model the task level actions of the project in the Channel One domain. For both cases, although achieved by different means, the Channel One function was achieved and was capable of being identified using the VSM framework for analysis of project management structure.

## **CHANNEL TWO – CROSS CASE REVIEW**

This section presents the findings of what the VSM shows as the similarities and differences between the Channel Two functions within the two case studies. Similarities of Channel Two functions are discussed first followed by their differences. The primary Channel Two functions of the two projects were identified as communications between the operations side of the S1, usually occurring at the weekly meetings for both projects. Minutes were generated and distributed from these meetings. Each of the weekly meetings included discussion of current and planned resources in relation to the overall project. When the task leads and members of the team were going to be out (e.g. travel, leave, etc.) was also discussed, giving the project team insight to everyone's whereabouts. BFM and contractor provided financial data was reviewed to ensure work was progressing as expected along with expenditures during these meetings for both projects. The C2 channels were used for coordination and exchange of information via meetings, emails, and telephone conversation within both projects. (PQ: EI-[6-20, 37-50]; PT: EI-[5, 11-18, 51, 56]).

Project 'T' C2 communications appeared to be with sponsors and the project lead at times (PT: EI-[5, 11-18, 51, 56]). Operations were not totally segregated from management functions.



Conversely, with Project ‘Q’, C2 communications were primarily within the operations of S1; updates and data calls were then provided to management as required (PQ: EI-[6-20, 37-50]).

Table 68 below shows the similarities and differences that the VSM was able to highlight during the cross case analysis of the two case study narratives:

Similarities	Differences
Both communicated information and coordination efforts via emails, meetings, and phone conversations.	Project 'T' C2 channel appeared to communicate with sponsors and the project lead at times. Operations were not totally segregated from management functions.
Minutes were used to document the communications.	Project 'Q' C2 channel was primarily talked about the operations of S1; updates provided to management and data calls answered as needed.

**Table 68: Channel Two Similarities and Differences Summarized**

Although the two project teams handled Channel Two’s functions differently, this does not diminish the fact that the VSM was able to model the task level actions of the project in the Channel Two domain. For both cases, although achieved by different means, the Channel Two function was achieved and was capable of being identified using the VSM framework for analysis of project management structure.

### **CHANNEL THREE – CROSS CASE REVIEW**

This section presents the findings of what the VSM shows as the similarities and differences between the Channel Three functions within the two case studies. Similarities of

Channel Three functions are discussed first followed by their differences. The primary Channel Three functions of the two projects were identified as communication primarily between the S3's and S1's which provided project updates and examined the communications which helped define the management style used within this channel. The task leads had discussions concerning their task at the weekly meetings whose minutes were recorded and distributed. The task leads had group meetings with their team. Daily working discussions helped capture the data for reporting. The weekly meeting format was used to brief all on the project team members. At times the discussions of an ongoing task were discussed with the sponsor and the task lead (and its team). The results were filtered to the project lead for submission up to the S3 (primarily the project lead and BFM).

The C3 communication channel communicates between the S3 and S1 elements of the managerial portion of the S1's providing corporate updates. The task leads of both projects received updates from management through these channels. Communications for both projects took the form of emails (primarily) and during group meetings (PQ: EI-[1-46, 66, 78, 95, 100, 108, 123, 144, 163, and 164]; PT: EI-[1-33, 46, 48, 49-58, 66, 77-8, 80, 84-5, 105-116, 10]). Management functions of S3 provided data call formats, briefing templates, and project requirements mostly through emails that would have corresponding policies and procedures to be followed (PQ: EI-[1-46, 66, 78, 95, 100, 108, 123, 144, 163, 164]; PT: EI-[1-33, 46, 48, 49-58, 66, 77-8, 80, 84-5, 105-116, 10]).

The most noticeable difference between the two projects in how C3 communications occurred was that Project 'T' communications between the S1's and S'3 were not transparent with the S1-S3-S4-S5 line (PQ: EI-[1-46, 66, 78, 95, 100, 108, 123, 144, 163, 164]; PT:EI-[1-33,

46, 48, 49-58, 66, 77-8, 80, 84-5, 105-116, 10]). Group meetings tended to absorb all management functions at one time. Conversely, Project 'Q' C3 efforts typically were a briefing of corporate policies from management S3 entities to the S1 community (PQ: EI-[1-46, 66, 78, 95, 100, 108, 123, 144, 163, 164]; PT: EI-[1-33, 46, 48, 49-58, 66, 77-8, 80, 84-5, 105-116, 10]).

Table 69 below shows the similarities and differences that the VSM was able to highlight during the cross case analysis of the two case study narratives:

Similarities	Differences
The C3 communication channel communicates between the S3 and S1 elements of the managerial portion of the S1's providing corporate updates.	Project 'T' communications between the S1's and S'3 were not transparent with the S1-S3-S4-S5 line.
The task leads of both projects received updates from management through these channels.	Project 'T' group meetings tended to absorb all management functions at one time.
Communications for both projects took the form of emails primarily and during group meetings.	Project 'Q' C3 efforts typically were a briefing of corporate policies from management S3 entities to the S1 community.
Management functions of S3 provided data call formats, briefing templates, and project requirements.	

**Table 69: Channel Three Similarities and Differences Summarized**

Although the two project teams handled Channel Three's functions differently, this does not diminish the fact that the VSM was able to model the task level actions of the project in the

Channel Three domain. For both cases, although achieved by different means, the Channel Three function was achieved and was capable of being identified using the VSM framework for analysis of project management structure.

#### **CHANNEL FOUR – CROSS CASE REVIEW**

This section presents the findings of what the VSM shows as the similarities and differences between the Channel Four functions within the two case studies. Similarities of Channel Four functions are discussed first followed by their differences. With changes in schedule frequent, the need for resources and the availability of resources changed in both projects. The task leaders were able to solidify prior arrangements or discussed current options for exchanging resources and adjusting schedules amongst themselves; ensuring their efforts did not affect overall project baselines. The C4 channel is used between S3 and S1 for resource bargaining between the different task leads of the projects. For both projects, the group meetings were the primary areas where resources were discussed (PQ: EI-[1-46, 66, 78, 95, 100, 108, 123, 144, 163, and 164]; PT: EI-[1-33, 46, 48, 49-58, 66, 77-8, 80, 84-5, 105-116, 10]). As updates of individual tasks were discussed with the project lead, insight into priority changes were presented. It was primarily during group meetings where discussion of resources changes was discussed (PQ: EI-[1-46, 66, 78, 95, 100, 108, 123, 144, 163, and 164]; PT: EI-[1-33, 46, 48, 49-58, 66, 77-8, 80, 84-5, 105-116, 10]). The task leads would bargain amongst themselves for resources as they understood the overall project situation. Final approval of resource changes came from the project lead (PQ: EI-[1-46, 66, 78, 95, 100, 108, 123, 144, 163, and 164]; PT: EI-[1-33, 46, 48, 49-58, 66, 77-8, 80, 84-5, 105-116, 10]).

Most notably, the biggest difference between the two projects was how the S1-S3 discussion were merged with S1-S3-S4-S5 discussion during Project ‘T’'s group meetings (PQ: EI-[1-46, 66, 78, 95, 100, 108, 123, 144, 163, 164]; PT: EI-[1-33, 46, 48, 49-58, 66, 77-8, 80, 84-5, 105-116, 10]).

Table 70 below shows the similarities and differences that the VSM was able to highlight during the cross case analysis of the two case study narratives:

Similarities	Differences
Used for resource bargaining between the task leads and management.	The biggest difference between the two projects was how the S1-S3 discussion were merged with S1-S3-S4-S5 discussion during Project ‘T’'s group meetings.
Primarily during group meetings where discussion of resources changes were discussed.	

**Table 70: Channel Four Similarities and Differences Summarized**

Although the two project teams handled Channel Four’s functions differently, this does not diminish the fact that the VSM was able to model the task level actions of the project in the Channel Four domain. For both cases, although achieved by different means, the Channel Four function was achieved and was capable of being identified using the VSM framework for analysis of project management structure.

## **CHANNEL FIVE – CROSS CASE REVIEW**

This section presents the findings of what the VSM shows as the similarities and differences between the Channel Five functions within the two case studies. Similarities of Channel Five functions are discussed first followed by their differences. C5 is often called the anti-oscillatory channel between the S1's mitigated by the S2 coordination efforts. C5 is the channel between which S1 resolves conflicts with S2 mitigating the effort. The presentation of schedules and baselines (IMS) helped to ensure all the task members were aware of where the resources were initially planned in both projects. Conflicts or changes between S1's that affected other tasks were often brought up early and mitigated primarily in weekly project meetings for both of the project cases (PQ: EI-[1-46, 66, 78, 95, 100, 108, 123, 144, 163, 164]; PT: EI-[1-33, 46, 48, 49-58, 66, 77-8, 80, 84-5, 105-116, 10]).

Most notably, the biggest difference between the two projects was how the S1-S2 discussion was merged with S1-S2-S3-S4-S5 discussions during Project 'T's group meetings (PQ: EI-[1-46, 66, 78, 95, 100, 108, 123, 144, 163, 164]; PT: EI-[1-33, 46, 48, 49-58, 66, 77-8, 80, 84-5, 105-116, 10]). There were no evidence items that showed that the S1's mitigated problems outside of the overall group meetings. Conversely, Project 'Q' demonstrated when a S1 task issue would come up between task leads; they would discuss between themselves and resolve the issue (PQ: EI-[1-46, 66, 78, 95, 100, 108, 123, 144, 163, and 164).

Table 71 below shows the similarities and differences that the VSM was able to highlight during the cross case analysis of the two case study narratives:

Similarities	Differences
C5 is the channel between which S1 resolves conflicts with S2 mitigating the effort.	How the S1-S2 discussion were merged with S1-S2-S3-S4-S5 discussions during Project 'T''s group meetings.
The presentation of schedules and baselines (IMS) helped to ensure all the task members were aware of where the resources were initially planned in both projects.	
Conflicts or changes between S1's that affected other tasks were often brought up early and mitigated primarily in weekly project meetings for both of the project cases.	

**Table 71: Channel Five Similarities and Differences Summarized**

Although the two project teams handled Channel Five's functions differently, this does not diminish the fact that the VSM was able to model the task level actions of the project in the Channel Five domain. For both cases, although achieved by different means, the Channel Five function was achieved and was capable of being identified using the VSM framework for analysis of project management structure.

## **CHANNEL SIX – CROSS CASE REVIEW**

This section presents the findings of what the VSM shows as the similarities and differences between the Channel Six functions within the two case studies. Similarities of Channel Six functions are discussed first followed by their differences. Both projects are within the same organization and the process and procedures for organization audits are the same. The

projects have reviews coordinated by the competency and the Portfolio side of the command. The reviews occur at least annually and are pre-planned periods of time, but the reviews do not occur at the same time for each project. The Sub-Portfolio lead also monitors the projects and project groups and can call a review at any time. Additionally, the outside customer/sponsor calls for review, typically semi-annually for each project (PQ: EI-[1-46, 66, 78, 95, 100, 108, 123, 144, 163, and 164]; PT: EI-[1-33, 46, 48, 49-58, 66, 77-8, 80, 84-5, 105-116, 10]). These are the formal audit like reviews and reporting on tasking. Outside government agencies can also perform audits based on the agencies criteria. The S3 coordinates with the S3 \* (Star) functional group to perform these audits and reviews and is communicated along the C6 Channel.

The biggest difference in the C6 between the two projects was that Project ‘T’'s S3-S4-S5 management team is blurred and acts more as one management team in comparison with the Project ‘Q’'s S3-S4-S5 management team (PQ: EI-[1-46, 66, 78, 95, 100, 108, 123, 144, 163, 164]; PT: EI-[1-33, 46, 48, 49-58, 66, 77-8, 80, 84-5, 105-116, 10]). Project ‘Q’ sets a specific agenda and groups together to participate in the audit whereas in Project ‘T’ everyone in management is involved with the project lead taking the lead audit role (PQ: EI-[1-46, 66, 78, 95, 100, 108, 123, 144, 163, 164]; PT: EI-[1-33, 46, 48, 49-58, 66, 77-8, 80, 84-5, 105-116, 10]).

Table 72 below shows the similarities and differences that the VSM was able to highlight during the cross case analysis of the two case study narratives:



Similarities	Differences
Process and procedures for organization audits are the same.	Project 'T's S3-S4-S5 management team is blurred and acts more as one management team in comparison with the Project 'Q's S3-S4-S5 management team.
Projects have reviews coordinated by the competency and the Portfolio side of the command.	
Reviews occur at least annually and are pre-planned periods of time.	
Sub-Portfolio lead also monitors the projects and project groups and can call a review at any time.	
Outside customer/sponsor calls for review, typically semi-annually for each project.	
S3 coordinates with the S3 * (Star) functional group to perform these audits and reviews and is communicated along the C6 Channel.	

**Table 72: Channel Six Similarities and Differences Summarized**

Although the two project teams handled Channel Six's functions differently, this does not diminish the fact that the VSM was able to model the task level actions of the project in the Channel Six domain. For both cases, although achieved by different means, the Channel Six function was achieved and was capable of being identified using the VSM framework for analysis of project management structure.

### **ALGEDONIC CHANNEL – CROSS CASE REVIEW**

This section presents the findings of what the VSM shows as the similarities and differences between the Algedonic Channel functions within the two case studies. Similarities of

Algedonic Channel functions are discussed first followed by their differences. The Algedonic Channel functions of the two projects were identified to be a direct communication to the project leads from the project team. The project lead is accountable for all aspects of a project. Sponsors, external stakeholders, internal support competencies, and management alike often targeted the project lead not only for problems but for data calls (PQ: EI-[1-46, 66, 78, 95, 100, 108, 123, 144, 163, and 164]; PT: EI-[1-33, 46, 48, 49-58, 66, 77-8, 80, 84-5, 105-116, 10]). Often data calls appeared to be treated as problems as they were the defense for the situation of concern. There was a channel that existed directly to the top: to the project lead.

The biggest difference in the Algedonic Channel between the two projects was that Project 'T' team members appeared to go to the top more often and not just for emergency issues (PQ: EI-[1-46, 66, 78, 95, 100, 108, 123, 144, 163, 164]; PT: EI-[1-33, 46, 48, 49-58, 66, 77-8, 80, 84-5, 105-116, 10]). Table 73 below shows the similarities and differences that the VSM was able to highlight during the cross case analysis of the two case study narratives:

Similarities	Differences
Both projects realized if there was a problem that could not be fixed within the chain of command, going to the Project Lead was encouraged.	Project 'T' team members appeared to go to the top more often and not just for emergency issues.
The project lead is accountable for all aspects of a project.	

**Table 73: Algedonic Channel; Similarities and Differences Summarized**

Although the two project teams handled Algedonic Channel functions differently, this does not diminish the fact that the VSM was able to model the task level actions of the project in

the Algedonic Channel domain. For both cases, although achieved by different means, the Algedonic Channel function was achieved and was capable of being identified using the VSM framework for analysis of project management structure.

## **SUMMARY**

The cross case analysis served to provide face validation that using the case study research method for the structural analysis of projects using the VSM model provides useful results. The two projects both were able to be represented in terms of the five systems and six primary communication channels (also, the Algedonic Channel) that the VSM requires to maintain viability. The PMBOK points out the need for the strategic views of the organization to be channeled through the Project lead. Within the VSM, this is primarily an S4 system function of which the project lead is a member. Each project's S3-S4-S5 System appears to collapse together almost as an indistinguishable function, with one project more than the other. The matrix analysis did not clearly capture the algedonic channel to the S5 area (or project lead from a PMBOK perspective). But with follow up discussions with the teams and the associated project documentation, the project lead was ultimately and unquestionable the go to person when a clear channel was not working. From the other direction (from management) it was also clear that the project lead was the ultimate 'person to blame'.

## **CONCLUSION**

### **INTRODUCTION**

This chapter provides the conclusion and implications that resulted from this research effort. Interpretations of the significance and implications of the work for theory (fields), methodology, and practice are presented and explored. Examination of implications for the Body of Knowledge in program management and management cybernetics are discussed, including identification of fruitful areas for future research directions. How the research methodology was applied and the use of a rigorous case study research approach is also examined for implications of research practice in the engineering management and systems engineering fields. The examination of implications for practice, practitioners, and future research areas in the professions is also presented.

### **THEORY IMPLICATIONS**

This research effort has contributed to the Body of Knowledge in the fields of Program Management and the Management Cybernetics. The use of the VSM as a lens into the PMBOK's PMS was found to provide mechanisms for highlighting significant differences between the two models. These differences highlight an intersection between the two fields, with each field gaining insights and implications from one another. First, the algedonic channel, S2 (anti-oscillatory), C1 (environmental) channel, and the C5 (anti-oscillation) channel were weakly represented in PMBOK's PMS. Consideration of these channels and their implications for further evolution of the PMBOK and the project management field represent a significant development opportunity. The more sophisticated consideration of systems communication

channels identified in Management Cybernetics would add a more robust and depth accounting for the nature and role of communications in project management. Although project management considers communications, it can be enhanced significantly through the insights provided by the management cybernetics communications perspective and corresponding channels. Second, the lack of development of the operational component that was intentionally left out of the PMBOK suggests that perhaps a re-look at inclusion of this important factor in PMBOK for PM should be revisited. Project management is a life cycle driven approach that covers a ‘cradle to grave’ scope. There is significant opportunity to ‘re-examine’ a more ‘systemic’ consideration of the operational component suggested by the Viable System Model and Management Cybernetics. This does not diminish the project management field or PMBOK, but rather presents an opportunity to develop the field in fruitful directions. It is noteworthy from the present research that the relative absence of operational component considerations in the project management field (as denoted in the PMBOK), a void in the literature exists. Management Cybernetics might offer a significant step forward to more rigorously address operational component considerations. This is significant in that without a rigorous representation of the operational component of project management; both practitioners and researchers are left with a void. There is substantial opportunity for further project management field development using the operational (cybernetics) perspective provided by the Management Cybernetics field as depicted by the Viable System Model. Likewise, Management Cybernetics might be enhanced with application and development in relationship to the projection of the cybernetics operational elements to the project management domain.

There are several suggestions for future theoretical/conceptual areas of research based on the present research exploration and results. First, further research might include the study of PMS with additional projects. This research might lead to the ability to functionally categorization techniques that are currently unknown for PMS at the project and even program levels. The examination of additional 'systems based' approaches might extend the theoretical grounding for project management. As an applied field, project management has not generally been predisposed to focus on development of the underlying theoretical or conceptual basis that ground the field. The further grounding of project management through inclusion of the strong theoretical foundations found in systems theory and cybernetics present significant opportunities. The theoretical grounding of project management can serve to provide a greater 'anchoring' of a pragmatic field in a more sustainable paradigm. It might be suggested that the practical nature and development of the project management field has been largely exclusive of the deeper philosophical, theoretical, and paradigmatic depth essential to: (1) provide an intellectual grounding for the field, (2) inform the axiomatically consistent development of practical applications grounded in a sustainable knowledge base, (3) inform field development across the spectrum of theory to practice pursuit, and (4) support field evolution and trajectory that acknowledges the importance of a stable theoretical/conceptual base – a base that can act as a stable reference base upon which developments can be appropriately anchored – resisting surrender of long term grounded field evolution to short term operational expedience.

A second theoretical contribution was suggested concerning the use of cybernetics in the PMS Field through application in a case study research approach. This initial exploration demonstrated the potential contributions that might be made at the intersection of two fields that

have developed independent and mutually exclusive of one another. The intersection of the project management and management cybernetics fields has shown how each might benefit from the paradigm, application, and conceptual base of the other. In effect, the intersection of the fields permits potential insights that are not available within the more 'myopic' view of the individual field. This research has begun a more serious examination of the potential for further intersection of these fields. Several potentially fruitful avenues for further research to advance the theoretical foundations for project management are suggested from the research, including:

1. Further examination of the theoretical and conceptual basis for communications in project management from a systems/cybernetics frame of reference. While this research identified the more limited treatment of 'systems' treatment of communications in project management, there is much more that can be done to further develop this identified opportunity.
2. Additional depth of validation for findings concerning the nature of project management systems from a systems theoretic basis. This research has suggested the essence of a more rigorous application of systems theory (management cybernetics) in the project management field. There is significant additional research suggested to further examine the contributions that the theoretical basis of management cybernetics might offer to project management systems.
3. Elaboration of a Management Cybernetics based theory for project management. Based on the initial findings of this research there is certainly an opportunity to further explore the project management field. In essence, there might be significant theoretical contribution to develop a management cybernetics based theory of project

- management systems. While this is a rather broad undertaking, it might be initiated by establishment of a systems based research strand in the project management community.
4. There is a need for further elaboration of the underlying theoretical paradigm for project management. This research has demonstrated that project management is extremely limited in the existence or articulation of the underlying theoretical grounding of the field. It seems appropriate that Systems Theory/Management Cybernetics might provide a possibility for 'grounding' project management; it is not the only possibility. While project management has been around for some time, it has not been developed on a strong theoretical base. There is much to be done in contribution to the project management field by further examination of the historical, present, and potential future theoretical basis for the field.
  5. Further theory building at the program versus project level. The integration of multiple projects at a higher level might be well served by some theoretical development based in systems theory. Systems theory is ripe with extend language, concepts, and principles (e.g. recursion) that might offer additional insights into the integration of multiple projects into a higher level program. This presents the opportunity for extension of systems theory from a project management system level to a program management system level.

There is much to be gained through the further pursuit of the theoretical implications of the research suggested as ripe for further exploration and development.



## METHODOLOGY CONTRIBUTIONS

With respect to methodological contributions, this research effort exemplified how the use of Case Study Research (CSR) could be used to explore the Project Management Structure (PMS) of projects within an organization. With the use of rigorous case study designs, narratives were developed that provided “face” validation of the results that occurred during the analysis of PMS through the use of the VSM. This answered the second research question:

*What results from exploration of the Viable System Model framework application to active project management structures?*

By using the VSM as a guiding framework, the PMBOK PMS was seen to have weak representation in the areas of the Algedonic channel, the S2 function where anti-oscillation occurs, the C1 channel that interfaces to the environment, and the C5 communication channel associated with anti-oscillation. Each of these areas has implications for further development of the project management field. It is instructive that the richness of these discoveries was made possible by the pursuit of a rigorous case study research approach. It is somewhat doubtful that these discoveries would have been possible in more restrictive (theory testing) research designs. As such, the need for more robust research methodological alternatives for the engineering management field are suggested from the present research. This does not demean other research approaches. On the contrary, it serves to elucidate the potential that other research approaches might bring to both engineering management as well as the project management field. On the methodological front, this suggests that project management methodologies might be re-examined to include a more systems-based perspective. This might preclude exclusion of critical systems aspects identified in this research. This research suggests that further methodological

development in the project management field would be well served by a more robust accounting of the nature of systems theory implications for project management 'systems'. This suggests that case study research focused on project management systems from the perspective of systems theory/management cybernetics might prove advantageous in development of more advanced 'holistic' systems-based methodologies for the project management field. These methodologies might extend this research to other similar contexts and venues. This might suggest methodological pluralism in defining appropriate fitting of 'systems-based' methodologies to particular circumstances. However, as this research has shown, the more pronounced systems basis for consideration of project management might prove instructive. This would suggest the PMS from the perspective of the VSM could be used to study PMS in other projects – with methodologies adapted to particular circumstances. With an increased number of projects studied within the boundaries that meet the criteria of this research effort, future generalizations may be asserted through rigorous analysis serving to validate the application of the VSM/management cybernetics to the project management field. Additionally, methods based on this research effort could be expanded to commercial projects from which future generalizations might be possible with rigorous analysis. In recollection of the PMBOK disclaimer, PMBOK stated their standard did not include the operation side of project management. With this in mind, the matrix analysis conducted in this research points out the oscillation that one might expect in a project where scarce resources are being examined for potential redistribution. This type of scenario was not part of the PMBOK modeling guide for projects. As such, project management development methodologies based extensively on the PMBOK might be significantly limited for applicability in instances where resources are a considerable question. In line with this, the anti-oscillation

channel of C5 would also not be expected to be present in a PMBOK based model. An operational interface with the environment through the C1 channel would also not be present in a model that did not include operational functions. A need for a link to the project lead for operational related problems explains the low emphasis in the PMBOK discussions in relation to an Algedonic like channel. The matrix analysis of the PMBOK PMS was able then to highlight these project model differences through the VSM lens. Several potentially worthwhile directions for further research to build upon the methodological foundations suggested from this research include such areas as:

1. How can case study research be expanded to multiple government projects? Case study appears to be a viable approach to examine conceptually rich questions for project management system development. The further application of this approach to additional venues in application of systems theory will serve to strengthen both the findings of the research related to the project management systems as well as the methodological appropriateness to case study research for the project management field.
2. What results from the cross case analysis of these case studies in the exploration of PMS? The further examination of case study research across multiple cases (cross case) can further serve to demonstrate the utility of case study research for project management. Additionally, it can serve to identify differences in context (albeit government based projects) that might suggest differences in both approach to case study research as well as contextual considerations based on differences in projects

- and their settings. Again, the case study approach and applications might serve to bolster the systems based perspective for project management systems.
3. What are the modeling implications for application of the VSM as a modeling basis for the program level? This research has shown the ability to engage in examination of project management structure using the VSM and management cybernetics through case study research. However, there is significant opportunity to examine further methodological considerations for the VSM as a model based methodology for examination of project management systems. The research has provided a substantial start that demonstrates the advantages offered by management cybernetics as a different perspective for understanding project management systems. Nevertheless, there is substantial additional work that can be engaged to develop a VSM based methodology for PMS development.

This research effort has suggested that there are several developmental areas that might be pursued for using the VSM to study the PMS of projects and even programs. Extension of the case study research approach was demonstrated as a viable candidate to facilitate further examination of the application of management cybernetics to the project management field.

## **PRACTICAL CONTRIBUTIONS**

Several opportunities for future research to enhance the practice of project management have been identified during this effort. Several will be discussed in this section. However, first a unique observation was made during this study related to the potential for advancing practice of

project management systems. Stafford Beer (1981, 1979) referred to operation rooms that would be set up to monitor and control organizations. This was Beer's vision then and into the future. It's my observation that the operation rooms that's Beer speaks of are the management dashboards of today that monitor and control metrics of project performance. Beer's vision has been achieved! However, the research has also shown that there is much opportunity to improve on that vision by better inclusion of the management cybernetics upon which Beer based his concept of the operations room. While today's advanced technology did not exist in Beer's ability to project his 'operations room', nevertheless his concept was sound from a systems theoretic perspective. Unfortunately, while the technology of a 'dashboard' for project management has been achieved (e.g. cost, schedule, quality reporting) the more rigorous accounting of operational control, based in management cybernetics, has not been extrapolated to modern day project management systems. The present research has demonstrated the potential that bringing the management cybernetics framework (VSM) to modern day project management offers significant potential to advance the field.

The VSM was not designed to optimize a project's effectiveness or efficiency, but this may be an area for further practical research. If the channels of communication, for example, could be quantified and correlated to project performance, perhaps a numerical ranking of performance could be achieved. The definition of a ranking metric would with the boundaries of study. With multiple projects studied, statistical inferences could be made on the results. This would offer a more robust accounting of project performance based in a more rigorous systems based framework.

During this research effort, several practical applications of the use of VMS analysis on PMS were discovered. Primarily, the utility of using the systemically sophisticated VSM and management cybernetics was face validated through the case study research conducted. This occurred during the analysis of PMS at the project level using the VSM. As different people perceive different viewpoints from different perspectives, the application of VSM could normalize a PMS viewpoint and provide a broader potential calibration of the systems and channels found within a project using the VSM for analysis. In effect, the VSM offers a much more rigorous systems-based perspective for examination of a PMS. The inclusion of this systems-based examination of a PMS might hold significant insights for practitioners as they deal with modern complex system projects. An entirely different array of decisions, actions, and interpretations might accrue from the insights offered by practical application of the VSM. This practical set of implications might be beneficial across the spectrum of the project life cycle, including design, execution, development/maintenance, and closure.

Practitioners of project management are routinely called upon by various stakeholders for data concerning the status of assigned projects. In monitoring projects, the project manager is in need of the status for all functions S1-S5 of the project(s). The concept of real-time monitoring of information updates on the project's systems and associated communication channels that make up the PMS of a project would benefit a project manager. A more systems based accounting of a project would provide a more 'holistic' accounting of project performance. Real-time data of the project in the form of dashboards would allow the project manager to engage in a different level of exploration which might generate the potential to make different (more systemically informed) decisions based on the most update information and different

vantage point provide by systemic (VSM) considerations. The metrics to be monitored in this extended 'systems/management cybernetics' project dashboard would be the project manager's choice of metrics, but could certainly be guided by the VSM to include direct updates of the status of the systems and channels within the PMS. A practical application of the dashboard would be beneficial to practitioners in need of real-time data on PMS. Future areas of research could extend this reach into the area of program management where multiple projects are managed within the same area. In essence, effective management cybernetics based PMS would engage project management practitioners in a different (systems) level of managing a project.

Project managers needing to 'defend' their project to organizational stakeholders could use this systems based process of analysis to establish that their project was a viable project management structure. Outside consultants or scholarly researchers could also use this 'VSM-based' PMS methodology to compare project structures against contextually grounded baselines appropriate for the particular circumstances of a unique project. Thus, the VSM would provide guidance as to 'what' must be done to achieve and maintain project viability. Determination of 'how' that would be achieved for a particular project would be the purview of the project manager. However, the VSM would provide a project manager with a robust frame of reference against which their project could be designed, analyzed, and developed at any point in the project life cycle. By being able to have a standard PMS for defining a viable project, practitioners would be able to compare like projects and develop advanced capabilities related to PMS design, execution, and development.

The PMBOK defines projects as temporary unlike the VSM that examines the 'viability' of the project and its relationship to the organization, without a stopping point. The VSM and

PMBOK provide a method for developing a framework for a project within an organization.

Thus, projects are dependent on organizations for resources with which they produce products/services; and ultimately value consumed externally to the project. In contrast, organizations are dependent on projects to produce continuing value (products/services) that is consumed either internally in the organization or externally. Following this thought, the 'people' resources that are used on projects belong to the organization, consistent with a matrix based project structure. There are several practice based future directions for research that have been suggested based on this research effort. Among these proposed research directions, with a pragmatic project emphasis, are the following questions:

1. What role do the 'people' as resources play to the PMS from a systems viewpoint?

People are the lifeblood of both organizations and projects. From a systems perspective, further examination of the role and nature of people within the PMS is a source for fruitful investigation. This would look at the intersection of the human element of project based organizations and particular roles that they might play, perhaps beyond the strict systems and project based aspects related to people. For example, there is a role that might be played by people beyond the PMS boundaries for getting additional work for the organization. This bypasses both the project management and management cybernetics fields.

2. How does the project benefit the workforce/organizational (i.e., training, purpose, experience, etc.) needs? The consideration of people, processes, and considerations beyond the particular scope of a project is an important aspect of project based organizations. It is important that this particular view does not escape consideration



for the potential impact it might have for project-based organizations. It is certainly not in the mainstream conversation for either the PMBOK or VSM. Further examination and inclusion of practice considerations would be beneficial for both fields.

3. How can the PMBOK PMS structure add the operational assets of PM to its standard/guidelines? This potential practice development area was identified as a potentially significant contribution to enhance project practice. Further examination and development of guidance related to development of the operational aspects of project management, based on management cybernetics might enhance the PMBOK. Minimally, this could include more holistic systems based considerations for operational aspects of project management not presently a focus for the PMBOK.
4. What specific guidance, frameworks, or methods can be developed for deployment of the VSM/Management Cybernetics to support more effective practices in PMS? There has been much knowledge gained from the present research exploration. However, from the practitioner/practice perspective, there is an opportunity to prepare guidance and frameworks that can support practitioners responsible for the design, execution, analysis, maintenance, and development of PMS. Projecting research results to enable this community of PM practitioners to be more effective is a worthy undertaking to 'push' the research results in ways that can improve the practice of PM and support better performing PMS.
5. What 'Viable System Model based metrics' might be developed and deployed to more holistically account for systems-based project performance and serve to

rank/rate projects within an organization's Program/Portfolio? The impact to strategic project planning on resources and project selection may benefit from metrics that use viability as a variable. The development of a more robust set of metrics for a PMS might serve to better capture performance of a project across a more robust set of 'systems-based' performance considerations. This would allow practitioners to engage in project analysis from a more holistic perspective and perhaps generate a much wider aperture of understanding a PMS and implications for systemic improvements.

The VSM is well suited as an informing model for the PMS. Future areas could use the VSM to allow the practitioners of PM to visualize the PMS of their various projects. A use of the VSM modeling technique could be used as a guidance method for project managers wanting to better understand the structure of their projects and with further research this method could be expanded to include the structure of their programs. This expansion into program management structure could be researched along the lines of this current research to expand the implication boundaries.

## **SUMMARY**

The goal of this research effort was to show the VSM could be used to explain the PMS of projects within an organization. This exploration of Management Cybernetics with respect to project structure contributes to the body of knowledge within the PMS domain. Table 62 below summarizes the significant contributions for this research effort as expanded in this chapter:

Significant Contributions of this Research Study	
Theoretical	<ol style="list-style-type: none"> <li>1. Contributed to the field of PM and Management Cybernetics.</li> <li>2. Extension of the VSM to PMS.</li> <li>3. Use of cybernetics in the PMS Field through the application in a CSR approach.</li> <li>4. Use rigorous case design for engineering management systems.</li> </ol>
Methodological	<ol style="list-style-type: none"> <li>1. Exploration of System Theory with respect to project structure.</li> <li>2. Expanding the use of Case Study Research for PMS and the use of case narratives for face validation.</li> </ol>
Practical	<ol style="list-style-type: none"> <li>1. VSM analysis of PMS.</li> <li>2. The utility of using the systemically sophisticated VSM and management cybernetics was face validated though the case study research that was conducted.</li> <li>3. The need for real time monitoring of projects from a system's perspective though dashboards.</li> <li>4. The need for project priority determination through viability metric.</li> </ol>

**Table 62: Significant Contributions of this Research Study**

Table 63 below summarizes the areas of future research in terms of theoretical, methodological and practical areas described in this chapter:

	Areas for Future Research
Theoretical	<ol style="list-style-type: none"> <li>1. Further examination of the theoretical and conceptual basis for communications in project management from a systems/cybernetics frame of reference.</li> <li>2. Additional depth of validation for findings concerning the nature of project management systems from a systems theoretic basis.</li> <li>3. Elaboration of a Management Cybernetics based theory for project management.</li> <li>4. There is a need for further elaboration of the underlying theoretical paradigm for project management.</li> <li>5. Further theory building at the program versus project level.</li> </ol>
Methodological	<ol style="list-style-type: none"> <li>1. How can case study research be expanded to multiple government projects?</li> <li>2. What results from the cross case analysis of these case studies in the exploration of PMS?</li> <li>3. What are the modeling implications for application of the VSM as a modeling basis for the program level?</li> </ol>
Practical	<ol style="list-style-type: none"> <li>1. What role do the ‘people’ as resources play to the PMS from a systems viewpoint?</li> <li>2. How does the project benefit the workforce/organizational (i.e., training, purpose, experience, etc.) needs?</li> <li>3. How can the PMBOK PMS structure add the operational assets of PM to its standard/ guidelines?</li> <li>4. What specific guidance, frameworks, or methods can be developed for deployment of the VSM/Management Cybernetics to support more effective practices in PMS?</li> <li>5. What ‘Viable System Model based metrics’ might be developed and deployed to more holistically account for systems-based project performance and serve to rank/rate projects within an organization’s Program/Portfolio?</li> </ol>

**Table 63: Areas for Future Research**

The primary goal of this research effort was to show the VSM could be used to explain the Project Management Structure (PMS) of projects within an organization. This research effort also exemplified how the use of Case Study Research (CSR) could be used to explore the PMS of projects within an organization. Potential future research areas were found and discussed in

the areas of theory, methods, and practical applications as a result of this research effort. The goal of this research effort is now complete; a journey of enlightenment and discovery for the researcher that has forever changed my perspective of Project Management Structures.

## REFERENCES

- Argyris, C., Schön, D.A. (1996). *Organizational Learning II: Theory, Method, and Practice*, Addison-Wesley Publishing Company.
- Aramo-Immonen, Vanharanta, H. (2009). Project Management: The Task of Holistic System Thinking, *Human Factors and Ergonomics in Manufacturing*, 19(6), 582-600.
- Artto, K., Martinsuo, M., Gemünden, H.G., Mertoaro, J. (2009). Foundations of program management: A bibliometric view, *International Journal of Project Management*, 27, 1-18.
- Ashby, R.W. (1956). *An Introduction to Cybernetics*, London: Chapman & Hall, Ltd.
- Ashby, R.W. (1960). *Design for a Brain: The origin of adaptive behavior*, John Wiley and Sons.
- Aubry, M., Hobbs, B., Thuiller, D. (2007). A New Framework for understanding organizational project management through the PMO, *International Journal of Project Management*, 25, 328-336.
- Beer, S. (1959). *Cybernetics and Management*, John Wiley and Sons.
- Beer, S. (1965). The World, The Flesh and the Metal\*: The Prerogatives of Systems, Nature Publishing Group, 4968, 223-231.
- Beer, S. (1966). *Decision & Control, The Meaning of Operational Research & Management Cybernetics*, John Wiley and Sons.
- Beer, S. (1967). *Management Science: The Business Use of Operations Research*, Doubleday and Company, Inc.
- Beer, S. (1974). *Designing Freedom*, John Wiley and Sons.
- Beer, S. (1978). *Platform for Change*, John Wiley and Sons.
- Beer, S. (1979). *The Managerial Cybernetics of Organizations, The Heart Of Enterprise*, John Wiley and Sons.
- Beer, S. (1981). *The Managerial Cybernetics of Organizations, Brain of The Firm* John Wiley and Sons, , (2<sup>nd</sup> ed.).
- Beer, S. (1985). *Diagnosing the System for Organizations*, John Wiley and Sons.
- Beer, S. (1994). *The Managerial Cybernetics of Organizations, Beyond Dispute The Invention Of Team Syntegrity*, John Wiley and Sons.
- Beer, S. (2000). *Ten Pints of Beer: The Rationale of Stafford Beer's cybernetic books (1959-04)*, *Kybernetes*, MCB University Press, 29(5/6), 558-572.
- Britton, G. A., & Parker, J. (1993). An explication of the viable system model for project management. *Systems Practice*, 6(1), 21-51.
- Brocklesby, J., Cummings (1996). *Long Range Planning*, Elsevier Science Ltd., 29(1) 49-57.
- Caron, F., Fumagalli, M., Rigamonti, A. (2007). Engineering and Contracting Projects: A value at risk based approach to portfolio balancing, *International Journal of Project Management*, 25, 569-578.
- Checkland, P. (1993). *Systems Thinking, Systems Practice*, John Wiley and Sons.
- Cicmil, S., Williams, T., Thomas, J., Hodgson D. (2006). Rethinking Project Management: Researching: the activity of projects, *International Journal of Project Management*, 24, 675-686.
- Clemson, B. (1984). *CYBERNETICS: A New Management Tool*, Abacus Press.

- Corbin, J., Strauss, A. (2008), *Basics of Qualitative Research; Techniques for Developing Grounded Theory*, Sage Publications, Inc., (3<sup>rd</sup> ed.).
- Creswell, J.W. (2009). *Research Design: Qualitative, Quantitative, and Mixed Methods Approaches*, Sage Publication, (3<sup>rd</sup> ed.).
- Creswell, J.W. (2014). *Research Design: Qualitative, Quantitative, and Mixed Methods Approaches*, Sage Publication, (4<sup>th</sup> ed.).
- Denzin, N.K., Lincoln, Y.S. (2005). *The Sage Handbook of Qualitative Research*, Sage Publications, (3<sup>rd</sup> ed.).
- Dietrich, P., Lehtonen, P. (2005), Successful management of strategic intentions through multiple projects – Reflections from empirical study, *International Journal of Project Management*, 23(5), 386-391.
- Espejo, R., Harnden, R. (1989). *The Viable System Model, Interpretations and Applications of Stafford Beer's VSM*, John Wiley and Sons.
- Gharrajedaghi, J., (1999). *Systems Thinking: Managing Chaos and Complexity*, Butterworth-Heinemann.
- Gibbs, G.R., *Qualitative Data Analysis Explorations with NVivo*, Open University Press.
- Glasser, B.G, Strauss, A.L. (2010). *The Discovery of Grounded Theory: strategies for qualitative research*, Aldine Transaction.
- Harnden, R., Leonard, A. (1994). *How Many Grapes Went Into the Wine: Stafford Beer On the Art and Science of Holistic Management*, John Wiley and Sons.
- Hobbs, B., Aubry, M. (2007). A Multi-Phase Research Program Investigating Project Management Offices (PMOs): The Results of Phase 1, *Project Management Journal*, 38(1), 74-81.
- Hodgson, D, Cicmil, S. (2006). New Possibilities for Project Management Theory: A Critical Engagement, *Project Management Journal*, 37(3), 111-122.
- Hoverstadt, Patrick (2008). *The Fractal Organization: Creating Sustainable Organizations with The Viable System Model*, John Wiley and Sons.
- Karayaz, G., Keating, C. B., & Henrie, M. (2011, January). Designing Project Management Systems. In *IEEE 2011 44th Hawaii International Conference on System Sciences (HICSS)*, 1-10.
- Keating, C. and Varela, M. (2002). Project Management Systems. In.: *Proceeding of the 23rd Annual American Society for Engineering Management. (pp. 1-11) Tampa, Florida*
- Keating, Charles B. (2000). Improving Practice: A systems-based methodology for structural analysis of health care operation, *Journal of Management in Medicine*, 14(¾), 179-198.
- Kerzner, H. (1998). *Project Management A Systems Approach to Planning, Scheduling, and Controlling*, John Wiley and Sons, (6<sup>th</sup> ed.).
- Kolltveit, B.J., Karlsen, J.T., Gronhaug, K.(2007). Perspectives on Project Management, *International Journal of Project Management*, 25, 3-9.
- Leedy, Paul D., Ormrod, J. E. (2010). *Practical Research: Planning and Design*, Pearson Education, Inc., (9th ed.).
- Leonard, A. (2009). *The Viable System model and Its Application to Complex Organizations*, System Pract Action res (Springer), 22, 223-233.
- Martinsuo, M., Hensman, N., Artio, K., Kujala, J., Jaafari, A. (2006), Project-based Management as an Organizational Innovation: Drivers, Changes, and Benefits of Adopting Project-

- Based Management, *Project Management Journal*, 37(3), 87-97.
- Medina, Eden (2006). Designing Freedom, Regulating a Nation: Socialist Cybernetics in Allende's Chile, *Cambridge University Press*, 38, 571-606.
- Nicholas, John M, Steyn, Herman (2008). *Project Management for Business, Engineering, and Technology*, (3<sup>rd</sup> ed.), Elsevier, Inc.
- Olsson, N. O. E. (2006). Management of Flexibility in projects, *International Journal of Project Management*, 24, 66-74.
- Pant, I., Baroudi, B. (2008). Project Management Education: The human skills imperative, *International Journal of Project Management*, 26, 124-128.
- Patton, Michael Q. (2002). *Qualitative Research & Evaluation Methods*, Sage Publications, (3<sup>rd</sup> ed.).
- Perez, Ríos J. (2012). *Design and Diagnosis for Sustainable Organizations: The Viable System Method*, Springer-Verlag Berlin Heidelberg.
- Pickering, A. (2002). Cybernetics and the Mangle: Ashby, Beer, and Pask, *Social Studies of Science*, 32(3), 413-437.
- Pieter van Donk, D., Molloy, E. (2008). From Organizing as Projects to Projects as Organizations, *International Journal of Project Management*, 26, 129-137.
- Project Management Institute, Inc. (2008), A Guide to the Project Management Body of Knowledge (PMBOK Guide), (4<sup>th</sup> ed.), *Project Management Institute, Inc.*
- Project Management Institute, Inc. (2013), A Guide to the Project Management Body of Knowledge (PMBOK Guide), (5<sup>th</sup> ed.), *Project Management Institute, Inc.*
- Pollack, J. (2007), The changing paradigms of project management, *International Journal of Project Management*, 25, 266-274.
- Reich, B. H. (2007). Managing Knowledge and Learning in IT Projects: A Conceptual Framework and Guidelines for Practice, *Project Management Journal*, 38, 5-17.
- Richards, L. (1999). *Using NVivo in Qualitative Research*, Sage Publication.
- Ríos, J. P. (2012). *Design and Diagnosis for Sustainable Organizations: The Viable System Method*, Springer-Verlag Berlin Heidelberg.
- Rozenes, S., Vitner, G., Spraggett, S. (2006). Project Control: Literature Review, *Project Management Journal*, 37(4), 5-14.
- Ruuska, I., Vartianinen (2005). Characteristics of knowledge sharing in communities in project organizations, *International Journal of Project Management*, 23, 374-379.
- Schein, E.H., (2010). *Organizational Culture and Leadership*, John Wiley and Sons, (4<sup>th</sup> ed.).
- Scott, Richard W. (1998). *Organizations Rational, Natural, and Open Systems*, Prentice Hall.
- Senge, P.M. (1990, 2006). *The Fifth Discipline*, Doubleday.
- Sense, A.(2008). The Conditioning of Project Participants' Authority to Learn within Projects, *International Journal of Project Management*, 26, 108-111.
- Srivannaboon, S. (2006). Linking Project Management with Business Strategy, *The Project Management Institute*, 37(5), 88-96.
- Stake, Robert E. (1995). *The Art of Case Study Research*, Sage Publications.
- Stake, Robert E. (2006), *Multiple Case Study Analysis*, New York: The Guilford Press.
- Stewart, R.A. (2008). A Framework for the Life Cycle Management of Information Technology Projects, ProjectIT, *International Journal of Project Management*, 26, 203-212.
- Strauss, A., Corbin, J. (1990). *Basics of Qualitative Research; Grounded Theory Procedures*



- and Techniques*, Sage Publications, Inc.
- Strauss, A.L., & Corbin, J.M. (1994). *Grounded theory methodology. An overview in Denzin's & Y. Lincoln (EDs) Handbook of Qualitative Research*: California, Sage Publications.
- Strauss, A.L., & Corbin, J.M. (1998). *Basics of qualitative research: techniques and procedures for developing grounded theory* (2<sup>nd</sup> ed.), Thousand Oaks: Sage Publications.
- Sutterfield, J. S., Friday-Stroud, S. S., Shivers-Blackwell, S. L. (2006). A Case Study of Project And Stakeholder Management Failures: Lessons Learned, *Project Management Journal*, 37(5), 26-35.
- Thiry, M., Deguire, M. (2007). Recent developments in project-based organizations, *International Journal of Project Management*, 25, 649-658.
- Wiener, N. (1950), *The Human Use of Human Beings: Cybernetics and Society*, The Riverside Press Cambridge.
- Wiener, N. (1948). *Cybernetics, Or Control And Communication In The Animal And The Machine*, John Wiley and Sons.
- Yin, Robert K. (2003). *Applications of Case Study Research*, (2<sup>nd</sup> ed.), Sage Publications.
- Yin, Robert K. (2009), *Case Study Research: Design and Methods*, Sage Publications, (4<sup>th</sup> ed.).
- Yin, Robert K. (2014), *Case Study Research: Design and Methods*, Sage Publications, (5<sup>th</sup> ed.).

## APPENDIX

### PROJECT 'Q': CASE STUDY REVIEW DRAFT

The following is the draft version of the Project 'Q' case study narrative that was given to the participating project team members of Project 'Q' for their review and comment. The purpose of the review was to provide face validation of the PMS of Project 'Q'. The case narrative contains typographical errors, inaccuracies and omission that were later corrected following the review process. The final corrected case narrative for Project 'Q' is included as Chapter V.

#### Project 'Q', A Case Study

The purpose of this study was to explore the applicability of the Viable System Model (VSM) as a framework for structural analysis of project management systems using a case study research design. This case study looked at the project management structure of an engineering project group within the government using the modified VSM framework as the analysis tool. This study showed how the adapted VSM could be used to model a project and highlight the areas of viability.

Today's body of knowledge of complex project-based organizations often focuses on its project management systems and how the organization is structured hierarchically. The Viable Systems Model (VSM) made famous by Stafford Beer was used to analyze an organization from a perspective that differed from the mainstream of the time. The VSM looked at structure not from a hierarchical view but rather the functional interaction of the individual systems and how they interacted iteratively. This study will help bridge the gap between the systems-based analyses of a project based organization and the analysis of its project management structure by

using the VSM as an analysis tool for viability. This paper used case study research as the rigorous methodology for research.

Case study research is used to enlighten and gain knowledge into complex social phenomena, which can be: a person, group of people, an organization, a social situation, or political phenomena (Yin, 2009). Yin states “the case study method allows investigators to retain the holistic and meaningful characteristics of real-life events – such as individual life cycles, small group behavior, organizational and managerial process, neighborhood change, school performance, international relations and the maturation of industries” (2009, p. 4). Case study research is a way of researching an empirical topic by following a set of pre-specified procedures while reviewing the logic of design, the data collection methodology, and specifies a unique data analysis approach (Yin, 2009, pp. 18-21). Yin (2009) describes a linear, but iterative process for doing case study research in his book, *Case Study Research: Design and Methods*, 4<sup>th</sup> edition. The guideline goes through the following processes: plan, design, prepare, collect, analyze, and share along with iterations (Yin, 2009).

This research used the exploratory case study as a methodology to study how the Viable System Model (VSM) can be adapted for analysis of the project management structure. The exploratory method was chosen as this is a “contemporary set of events” over which the researcher has little or no control over the organizational structure (Yin, 2009, p.12). This rigorous case study was based on the technical definition of case study research by Yin (Yin, 2009, p.18). Table 76 below shows a Bibliography of the Data Sources used for this case study and the associated dates the data was received or event (discussions/observation) performed:

Data Source File Number	Name – Description of Data Source	Date Received
0	PQ - [18] T&E WIPT	0518 2016
1	PQ-[18] T&E WIPT Minutes	0518 2016
2	PQ-Weekly SATCOM Meeting	0630 2016
3	PQ- Weekly SATCOM Meeting Minutes 0616 2016	0616 2016
4	PQ- Interview with [11] on 0627 2016	0627 2016
5	PQ- Interview with [07] on 0627 2016	0627 2016
6	PQ-NCLS Status Matrix	0616 2016
7	PQ - Interview with [18] on 0627 2016	0627 2016
8	PQ - Interview with [05] on 0628 2016	0628 2016
9	PQ - Interview with [12] on 0628 2016	0628 2016
10	PQ - Interview with [17] on 0627 2016	0627 2016
11	PQ- Project Financial Documents – Funding	0518 2016
12	PQ- Roles and Responsibilities	0518 2016
13	PQ- PMP	0518 2016
14	PQ-Weekly Activity Report (WAR)	0518 2016
15	PQ-Deliverable Tracking	0518 2016
16	Action Item Tracking	0518 2016
17	Program Management Review (PMR)	0518 2016
18	PQ- Team Communication Example from [00]	0518 2016
19	PQ - Interview with [00] on 0707 2016	0707 2016
20	PQ - POAM Example	0518 2016

**Table 76: Bibliography of Data Sources and Dates Received**

After choosing the project for the case study, I met with the project lead to get an understanding as to what I was looking for and get an idea of what kind of material may be available to me for this case study research. I advised the project manager that I would be using a case study protocol that I developed for this effort and may need to come back and ask further question or request further information as I began my research. Being a knowledgeable project manager with a master in engineering management, a bachelor degree in electrical engineering and knowledge

on the VSM, the project manager was able to attain and gather several documents for me to review. The project and the team were identified to me as I began to organize data in the case study database. Preliminary questions that I had assembled to be used for the CSR interviews proved to be helpful in guiding my interviews and ensured that the same basic questions were used throughout the initial phase of the interviews. The information from the interviews was incorporated into the case study database for later use.

### Methodology

The data from the case study database was analyzed and grouped into areas that would best match the foundation elements of the VSM: the Systems and the Channels. The results of the preliminary grouping began to describe the Systems and Channels. Once described fully, the Systems and channels would be drawn into the VSM to better visualize the results for the model of the project's PMS.

The basic VSM model as a template is shown below in Figure 32; shown to be the starting point for which case study data would be added to. As with the research paper, I first identified the Systems and followed with the identification of the primary six communication channels. Each system and channel was described individually, to better highlight the relationship with the case study database evidence items. The individual component of the model was combined into the Project 'Q' VSM at the conclusion of the case narrative.

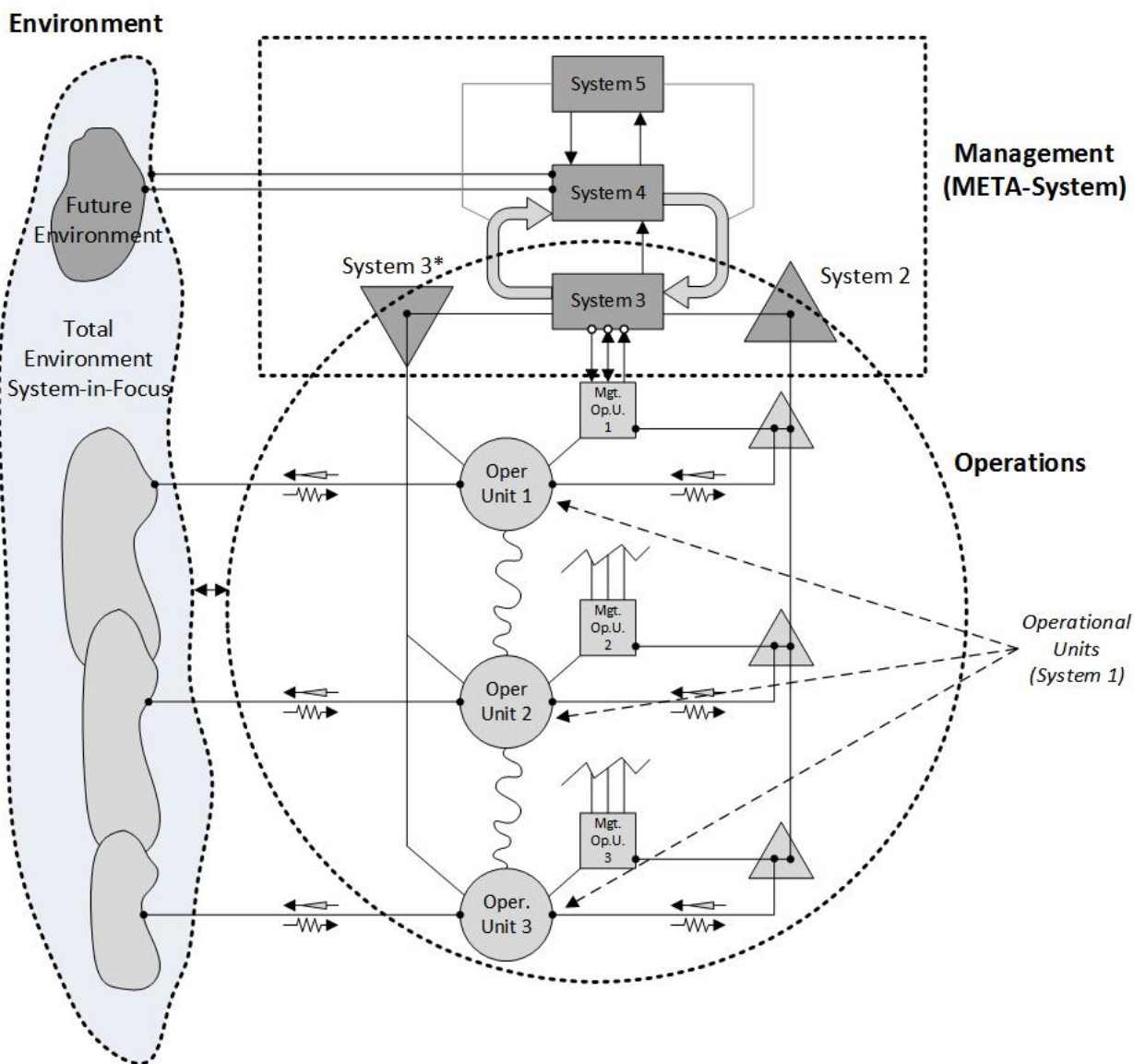

**Figure 32: VSM Diagram for a Project**

The primary System One functions of this project was the tasking that the sponsor had funded and passed on the project team in the form of the task planning letters and associated funding documents. The tasks descriptions are summarized for Project 'Q' as the below:

1. Government oversight of the project
2. Fleet Engineering Support
3. System Engineering Management
4. Acquisition Management
5. Financial Management
6. Integrate, Assembly, & Test Production
7. Removal of four (4) unit level variant

The tasks were combined at the project level based on how the project lead engaged. The tasking associated with the project, the System One's of this project model, became the following

(modeled for Project 'Q'):

1. Government Oversight/Acquisition/Financial Management of Project 'Q'
2. Fleet Engineering Support
3. System Engineering Management
4. Integrate, Assembly, & Test (Install/Remove) Production Support

The System One contained the scheduling data for the tasks and identified resources were scheduled and defined in S1. Definition of the sub tasks of the task leaders was described.

The System Two can best be described as the working relationship between the individual tasks leads and the interaction within the project lead. This interaction usually occurred at the weekly project meetings, at a PMR, or through email discussions. The function of System Two is to prevent oscillation between the System One's with respect to resources and other needs. The project lead sends an aggregated task proposal/estimate to the sponsor. The sponsor works with the project lead to accept and approve the estimate with the intent to fund. The agreement of this interaction is accomplished when the sponsor send the task planning letters and acceptance of this tasking letter by the project and organization. The funding document is the actual dollars being sent to the project for utilization. As the project team break downs the project into identifiable tasks, from the now aggregated estimate which may have been modified by the

sponsor, the government tasks leads use their previous estimates to baseline schedules, funding allocations, contract support, etc. If the project lead accepts the tasking and the team lead determines that their portion (task) is not properly funded, discussion to reduce this oscillation begins. The discussions are typically between the task lead and the project lead along with the BFM (others are included both for learning and as to be informed). If the problem can't be resolved between the S1's at the S3 level, the problem will rise up to the S5 level to resolve.

The individual System One's have both government and contract support team members. Some task leads combine their contractor and material procurement needs into a single combined contract to save dollars and management costs. Some oscillation can occur if for example the contractor begins to spend more than was allocated for their task on the single contract. Early detection and monitoring of the situation can reduce the oscillation and prevent further problems with this type of funding expenditures.

The System Three functionally was comprised of the task leads, the project lead, the BFM, and contractor team lead. This functional role is exercised during weekly meetings, government oversight functions, and contract negotiations. The "here-and-now" (Beer, 1981) of the current tasking and associated schedules are discussed. Resources are identified, tracked, and reported during these System Three level meetings and the information was then processed for distribution amongst the task leads and their team members, usually sent via email. System Three provides the project lead reports based on templates provided by the project lead.

The System Four was the most difficult to identify. In talking with the team members, most felt they got their strategic views from the program office/sponsor. This may be reflected in the weak identity the group has as project team within this organization. The project team itself



is part of a multi-organizational project team that the sponsor tasks. It is the same tasking. Within a competency aligned organization the project team, based on competency assignments, are members of a competency as well that provide human resources to the projects. In talking with [00] the project lead, the strategic planning goes beyond the future phase and into conversations with vendors and other organizational members. Task leads discuss future planned efforts formally but strategic tasking is more of an informal process at this time.

The System Four functional area of the project was a bit more difficult to identify. The project lead and task leads merged the task of developing a model of the status of the projects to be passed up to management and associated customers/stakeholders that warranted the reporting. Strategic efforts by some were thought to be future identified/proposed tasking whereas strategic in the sense of new work was discussed occasionally an informally. The discussion that did occur occurred between the project lead and task leaders (and any potential stakeholders) were at best referred to as brain storming.

The System Five identity of the project centered on the project lead and the BFM which have final negotiating authority over the tasking the project will do and except. The sponsor may informally dictate the name of the project based on the way estimates were routed up the government channels for approval and provided a source of funding. The reverse path is similar but may not be exact based on the requirements and priorities determined at each level. That is why the funding document is the determining factor as to what the project will be: the funding document matches requirements of the allocated funding. The project lead maintains the final vote for project related decisions within the organization and also is responsible for all the processes, data calls, and organizational procedures to be followed. The project is autonomous,

but not purely. Organizational management interference occurs and needs to be not filtered by the project lead.

The next phase deals with modeling the communication channel of the project to the VSM. The communication channels in the VSM are the elements that connect both the diverse functions specified in the VSM and the organization with its environment(s) (Ríos, 2012). The channels provide the equilibrium, balance or homeostasis of the internal environment of the system in view. The six primary channels of the VSM can be characterized as follows (Ríos, 2012, p 61):

1. Channel One - C1 - Channel connecting and absorbing variety between the environments of each elementary operational unit.
2. Channel Two – C2 – Channel connecting the various elemental operations (operational units making up System One).
3. Channel Three – C3 – Corporate intervention channel (System Three-System One).
4. Channel Four – C4 – Resources barraging channel (System Three – System One).
5. Channel Five – C5 – Anti-oscillatory channels (Co-ordination) (System Two).
6. Channel Six – C6 – Monitor channel (Auditor).

Algedonic Channel – Transmits alert signal concerning any event or circumstance that could jeopardize the organization. Communications travels straight to the top through existing links.

The six primary VSM communication channels can be seen in Figure 33 below:

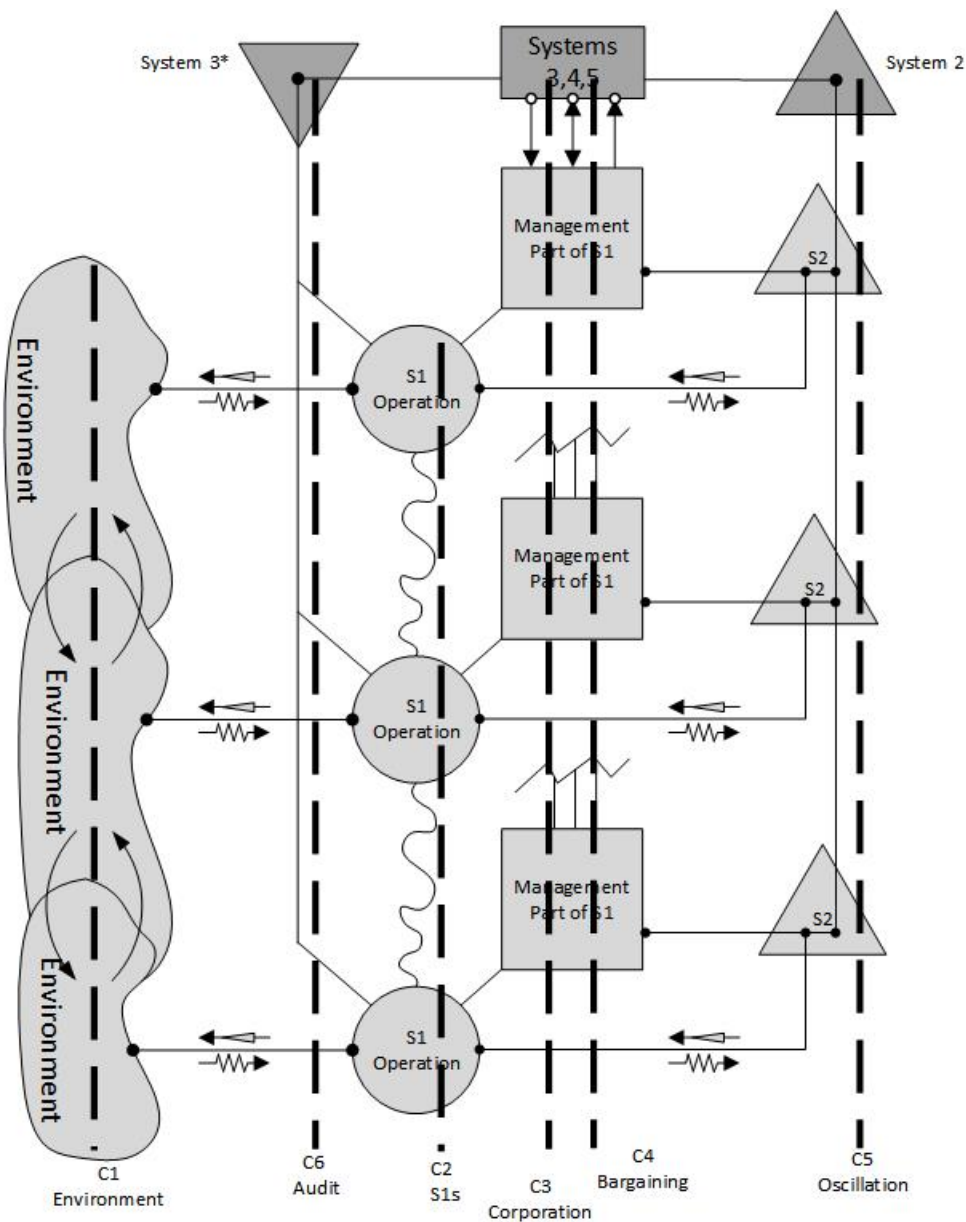
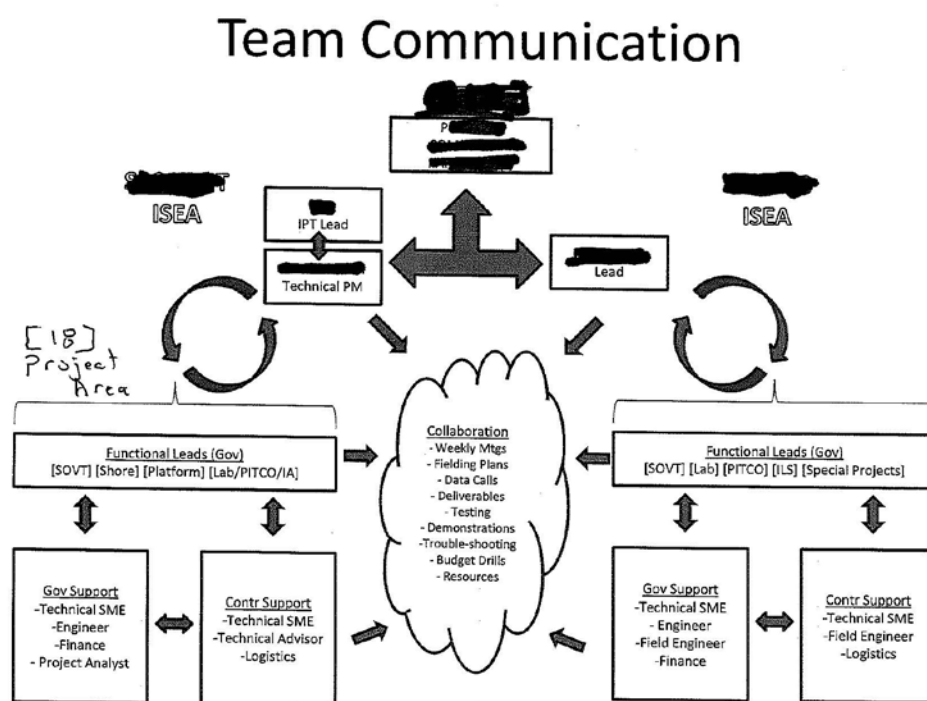

**Figure 33: The Six Primary Communication Channels of the VSM**

The case study database and the available artifacts provided were examined to develop and validate the use of the six primary channels of the VSM. The project lead provided a

communications diagram of how the project was supposed to communicate. This diagram was discussed at the higher level project team meetings that consisted of this project team and another along with the overall project sponsor. The project lead provided and discussed with the project team separately. The communication diagram is shown in Figure 34 below:

E#18



**Figure 34: Evidence #18 Team Communication Example**

When looking for elements of Channel One, the researcher looked for Communications between the S1's used for coordination and information. The communication paths were

specifically searched for would be between the specifically the task leads. The weekly meeting was an excellent example where the S1 leads discussed resources and made each other aware of the progress and situation going on in their area, a reflection of the overall project's progress. The Project Management Plan (PMP) directly discusses this need within the communication plan and was reinforced by both the project lead and the project sponsor. Interviews with [11] and [7] which are specific task leads under the project [18] confirmed this in their interviews. When looking for elements of Channel Two, the researcher looked for Communications Channel connecting the various operational (S1s) units. Communications between the S1's usually occurred at the weekly meetings. Minutes were generated and distributed. Each the weekly meeting current resource use and planned resource use for the different tasks was discussed. When the task leads and members of the team were going to be out either on travel, leave, etc. was also discussed, giving all the project team insight to everyone's whereabouts. BFM and contractor provided financial data was reviewed to ensure work progress as expected along with expenditures.

When looking for elements of Channel Three, the researcher looked for communication primarily between the S3 and S1's which provided project updates and examined the communications which helped define the management style used within this channel. The task leads as mentioned had discussion about their task at the weekly minutes whose minutes were recorded and distributed. The task leads would have group meetings with their team and daily working discussions that would help capture the data for reporting. The weekly meeting format was used to brief all on the project. At times the discussions of an ongoing task would be discussed with the sponsor and the task lead (and its team). The results being filtered to the

project lead for submission up to the S3 (primarily the project lead and BFM). The S3 would provide the task leads insights into the organization culture and decision making ongoing within the support areas of the organization for example contracts areas, managements project priorities, submission deadlines, training opportunities, etc.

When looking for elements of Channel Four, the researcher looked for areas where resource bargaining occurred between the S1's and S3's. With changes in schedule frequent, the need for resources and the availability of resources change. The task leaders are able to solidify prior arrangement or discuss current options for swapping resources and adjusting schedules amongst themselves, ensuring their efforts don't affect overall project baselines.

When looking for elements of Channel Five, the researcher looked for areas where S2's functional areas were working to reduce conflicts and other project level oscillations. The presentation of schedules and baselines helped to ensure all the task members were aware of where the resources were initially planned. Conflicts or changes that might affect another task were often brought up early and mitigated wither through email or during the meetings. Not all conflicts had time to be worked out prior to weekly meetings and the resolutions to those conflicts would be recorded in the weekly meetings and distributed.

When looking for elements of Channel Six, the researcher looked for areas that the project was monitored and control. A big area again was during the weekly minutes. Formal audits were conducted during a Program management review (PMR). Internal audits of the IPT (a layer above the project team) and projects have occurred (but not during this study). The project was questioned based on the auditor's team areas to examine. The project lead, task lead, and BFM were primarily the ones involved in these types of audits.

The algedonic channel was not very clear as the metasystem of S3 S4 and S5 were difficult to distinguish. In government organizations like this, and for this project, it was understood the project lead would be held accountable for all aspects of a project. Sponsors, external stakeholders, internal support competencies, and management alike often targeted the project lead not only for problems but for data calls. Often data calls appeared to be treated as problems as they were the defense for the situation of concern. It can be said that was a channel existed directly to the top: to the project lead.

Project 'Q' can be modeled with the VSM where the S1's would be:

1. Government Oversight/Acquisition/Financial Management of Project 'Q'
2. Fleet Engineering Support
3. System Engineering Management
4. Integrate, Assembly, & Test (Install/Remove) Production Support

The S5 would be the functional predominated by project lead and BFM lead actions. The task leads of S1 would be working with the project lead in the S3 functional role along with lead contractors at times. The S4 functional role was weak and difficult to distinguish as it appeared to be rolled up into S3 and S5 type functions. An effort was made to separate the S4 functional area. The VSM model below in Figure 35 can be used to describe the project where the functional elements were described in the narrative.

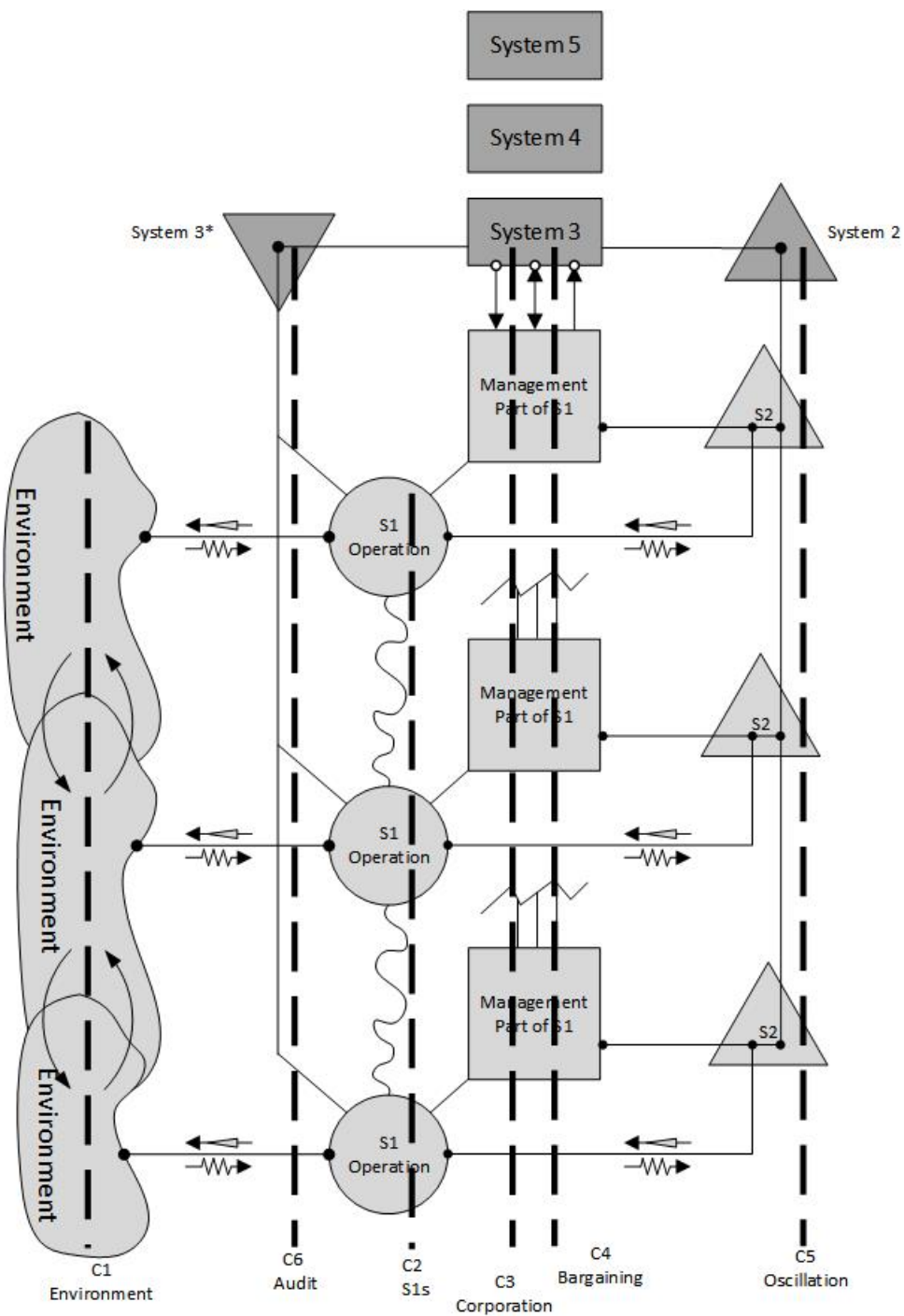

Figure 35: VSM of Project where the functional components are described in the narrative



## **PROJECT 'T': CASE STUDY REVIEW DRAFT**

The following is the draft version of the Project 'T' case study narrative that was given to the participating project team members of Project 'T' for their review and comment. The purpose of the review was to provide face validation of the PMS of Project 'T'. The case narrative contains typographical errors, inaccuracies and omission that were later corrected following the review process. The final corrected case narrative for Project 'T' is included as Chapter VI.

### *Project 'T', A Case Study*

The purpose of this study was to explore the applicability of the Viable System Model (VSM) as a framework for structural analysis of project management systems using a case study research design. This case study looked at the project management structure of an engineering project group within the government using the modified VSM framework as the analysis tool. This study showed how the adapted VSM could be used to model a project and highlighted the areas of viability.

## **Background**

Today's body of knowledge of complex project-based organizations often focuses on its project management systems and how the organization is structured hierarchically. The Viable Systems Model (VSM) made famous by Stafford Beer was used to analyze an organization from a perspective that differed from the mainstream of the time. The VSM looked at structure not from a hierarchical view but rather the functional interaction of the individual systems and how they interacted iteratively. This study helped bridge the gap between the systems-based analyses of a project based organization and the analysis of its project management structure by using the

VSM as an analysis tool for viability. This paper used case study research as the rigorous methodology for research.

Case study research is used to enlighten and gain knowledge into complex social phenomena, which can be: a person, group of people, an organization, a social situation, or political phenomena (Yin, 2009). Yin states “the case study method allows investigators to retain the holistic and meaningful characteristics of real-life events – such as individual life cycles, small group behavior, organizational and managerial process, neighborhood change, school performance, international relations and the maturation of industries” (2009, p. 4). Case study research is a way of researching an empirical topic by following a set of pre-specified procedures while reviewing the logic of design, the data collection methodology, and specifies a unique data analysis approach (Yin, 2009, pp. 18-21). Yin (2009) describes a linear, but iterative process for doing case study research in his book, *Case Study Research: Design and Methods*, 4<sup>th</sup> edition. The guideline goes through the following processes: plan, design, prepare, collect, analyze, and share along with iterations (Yin, 2009).

This research used the exploratory multiple case study as a methodology to study how the Viable System Model (VSM) could be adapted for analysis of the project management structure. The exploratory method was chosen as this is a “contemporary set of events” over which the researcher has little or no control over the organizational structure (Yin, 2009, p.12). This rigorous case study was based on the technical definition of case study research by Yin (Yin, 2009, p.18). The data was provided by the project leader [00] to ensure all data was vetted through the project lead. Several sources were used during the CSR. The Bibliography of the

Data Sources used for this case study and the associated dates the data was received or event (interview/observation) was performed are shown in Table 76 below:

Data Source File Number	Name	Date Received
0		
1	PMP For [1] - 7/18/16	7/18/2016
2	Org Chart - 7/18/16	7/18/2016
3	Spend Plan - 7/18/16	7/18/2016
4	[1] Weekly Team Minutes - 7/18/16	7/18/2016
5	Interview With [0] Project Lead - 8/11/16	8/11/2016
	Interview with [16] Technical manager	
6	8/12/16	8/12/2016
7	Sponsor Meeting Weekly 08/15/16	5/15/2016
	Interview with [14] Logistics and CM	
8	8/16/16	8/16/2016
9	Interview with [4] Video Task Lead 8/17/16	8/17/2016
10	Interview with [13 ] IA Manager 8/17/16	8/17/2016
	Interview with [20] Engineer Support	
11	8/17/16	8/17/2016

**Table 76: Bibliography of Data Sources and Dates Received**

After choosing the project for the case study, the researcher met with the project lead to get an understanding as to what was expected of the project team. The project lead was informed of the information/ material needed to be available to the researcher for this case study research. The researcher advised the project manager that a case study protocol would for the data analysis. The need to return and ask further questions or request further information was discussed. Being a knowledgeable project manager with a master in engineering management, a bachelor degree in Electrical Engineering, a master's in Engineering Management, the project manager was able to attain and gather several documents for review prior to the interviews. The project team

members were identified to the researcher. Volunteer members of the team would be interviewed on PMS of their project. Preliminary questions had been documented and were used for the CSR interviews proved to be helpful in guiding the interviews and ensured the same basic questions were used throughout the initial phase of the interview process. The information from the interviews was incorporated into the case study database for later use.

## Methodology

The data from the case study database was analyzed and grouped into theme areas that best matched the elements of the VSM: the Systems and the Channels. The results of the preliminary grouping began to describe the Systems and Channels. The case study data was then analyzed using the matrix analysis approach; the approach used for the VSM to PMBOK PMS structure matrix analysis. Evidence items that contained relevance (scored '3') were used in the narrative to support the associated themes; i.e. S1, S2, C1, etc. Table 77 below shows a portion of the tabular data from the matrix analysis of evidence data (from the case study database):

<b>Item</b>	<b>Evidence Description</b>	<b>Data Source Code</b>	<b>S 1</b>	<b>S 2</b>	<b>S 3</b>	<b>S3 *</b>	<b>S 4</b>	<b>S 5</b>	<b>C 1</b>	<b>C 2</b>	<b>C 3</b>	<b>C 4</b>	<b>C 5</b>	<b>C 6</b>
1	The project supports [02]. The project supports ISEA services, JITC testing, overall engineering and support for [01] (and	02-01-00-001-07-28-16	1		3		1	3	1	1	1	1	1	
2		02-01-00-001-07-28-16	3		3		2	3	1	2	3	3		1

	anything related) [02].													
	Deliverable:													
	JITC approved facility/products and enterprise engineering support/related documentation.	02-01-00-001-07-28-16	3	1	3	3	2	3	1	3	2	2		
3	Project team identified hierarchically ; PM [01], BFM [02],[3]-[11]. PMP, Configuration plan, quality assistance plan, and risk management plan identified as part of PMP. The [01] Requirements Management (REQM) Plan documents project requirements .	02-01-00-001-07-28-16	3	1	3	3	2	3	1	3	3	3		3
4	REQM Project processes for interpretation, agreement, and commitment to	02-01-00-001-07-28-16	3	2	3	3	3	3	1	3	3	3	1	3
5		02-01-00-001-07-28-16	3	1	3	3	2	3	1	3	3	3	1	3
6		02-01-00-001-07-28-16	3	1	3	3	2	3	1	3	3	3	1	3
7		02-01-00-001-07-28-16	3	1	3	3	2	3	1	3	3	3	1	3

	management and technical requirements													
	. Project approach to requirements documentation, traceability, and addressing changes.	02-01-00-001-07-28-16	3	1	3	3	2	3	1	3	3	3	1	3
8	Reviews and other mechanisms to ensure that inconsistencies between requirements, project plans, and work products are identified, tracked, and resolved.	02-01-00-001-07-28-16	3	1	3	3	2	3	1	3	3	3	1	3
9	The project schedule baseline is captured in Appendix B and will be updated on a weekly basis, or as necessary to reflect current data. In order to maintain an efficient	02-01-00-001-07-28-16	3	1	3	3	2	3	1	3	3	3	1	3
10		02-01-00-001-07-28-16	3	1	3	3	2	3	1	3	3	3	1	3

project  
schedule.

Task  
duration will  
be no less  
than 1 week  
(40 hours)  
for any  
project with  
a weekly  
update

11	requirement.	02-01-00-001-07- 28-16	3	2	3	3	1	3	1	3	3	3	2	3
----	--------------	---------------------------	---	---	---	---	---	---	---	---	---	---	---	---

**Table 77: Evidence Data with Matrix Analysis with Identifiers (Portion)**

Once the case study database evidence items were grouped into themes, the Systems and Channels were drawn into the VSM to better visualize the results for the model of the project’s PMS. The tabular information best describes the elements that form the Systems and Channels, as the diagram is nearly identical to the proposed VSM model. An example of how System One themes were identified from the data is shown below in Table 78:

## VSM

System	Definition(s)	Identifiers
S1	Elements concerned with performing the key transformations of the organization; produces the products. (Beer, 1981)	Produces the product or service; only system that is autonomous/viable buy itself (Beer, 1981)
	The autonomous unit that produces the product or service. (Beer, 1981)	Operates autonomously within agreed parameters (Keating, et al, 2012)
		Produce systems product and services to agreed-upon standards and performance levels within the allocated resources (Keating, et al, 2012)
		Interface with S2 for coordination within the larger systems (Keating, et al, 2012)
		Provide direct interface to the local system environment (Keating, et al, 2012)

**Table 78: S1 System Description**

Table 78 shows how the System One Identifier information from the VSM model was matched with the data from the case study database. The Systems and Channel information formed the basis of the narrative themes. The triangulation of evidence data in the case study database with the identifier information for systems and channels for the VSM are how the project's VSM model was developed. The matrix analysis was performed for each System and Channel themes within the case study database evidence entries. The data was used to form the case narrative and final adapted the VSM model for the project. The linkage back to the source data was maintained.



The basic VSM model as a template is shown below in Figure 36; shown to be the starting point for which case study data would be added to. As with the research paper, the researcher first identified the Systems and followed with the identification of the primary six Communication Channels. Each system and channel was described individually to better highlight the relationship with the case study database evidence items. The individual components of the model were then combined into the Project 'Q' VSM at the conclusion of the case narratives.

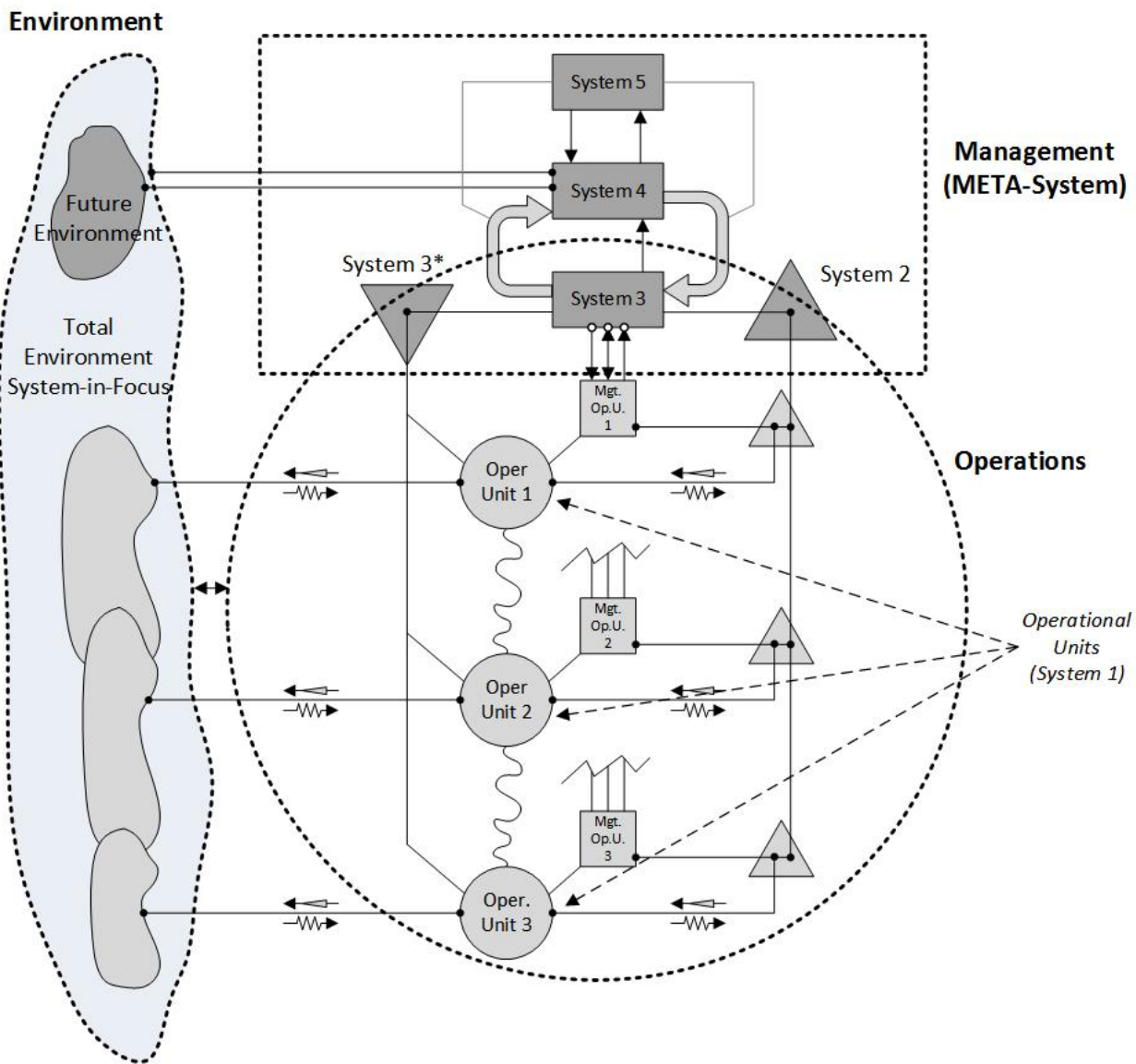

**Figure 36: Preliminary VSM Diagram for a Project**

## **System One Development from the CSR database**

The primary System One functions of this project were the tasking that the sponsor had funded and passed on to the project team in the form of the task planning letters and associated funding documents. The tasks descriptions are summarized for Project 'T 'as shown below:

1. Fleet Support/ISEA
2. IP Trunking
3. RTMS
4. TUMS VoSIP
5. VTCoSIP
6. VCS Expressway
7. NVCS Aegis Ashore
8. Unified Capabilities
9. Government oversight of Telephony Tasks

The System One's contained the scheduling data for the tasks. The System One's identified what resources were scheduled and defined. The definition of the tasks of the task leaders was described and identified as the S1's. System One definitions and identifiers used for analysis are shown for reference below in Table 78:

## VSM

System	Definition(s)	Identifiers
S1	Elements concerned with performing the key transformations of the organization; produces the products (Beer, 1981)	Produces the product or service; only system that is autonomous/viable buy itself (Beer, 1981).
	The autonomous unit that produces the product or service (Beer, 1981)	Operates autonomously within agreed parameters (Keating, et al, 2012).
		Produce systems product and services to agreed-upon standards and performance levels within the allocated resources (Keating, et al, 2012).
		Interface with S2 for coordination within the larger systems (Keating, et al, 2012).
		Provide direct interface to the local system environment (Keating, et al, 2012).

**Table 78: S1 Definition/Identifiers**

The System One definitions and identifiers from Table 78 above were used in a matrix analysis of evidence items within the CSR database. The a portion of evidence items that support the findings of a System One in the project are shown below in Table 79 below:

Item	Evidence Description	Data Source Code	S1	S2	S3	S3*	S4	S5	C1	C2	C3	C4	C5	C6	Alg.
2	The project supports ISEA services, JITC testing, overall engineering and support for [01] (and anything related) [02].	02-01-00-001-07-28-16	3		3		2	3	1	2	3	3			1
3	Deliverable: JITC approved facility/products and enterprise engineering support/related documentation.	02-01-00-001-07-28-16	3	1	3	3	2	3	1	3	2	2			
4	Project team identified hierarchically; PM [01], BFM [02],[3]-[11].	02-01-00-001-07-28-16	3	1	3	3	2	3	1	3	3	3			3
5	PMP, Configuration plan, quality assistance plan, and risk management plan identified as part of PMP.	02-01-00-001-07-28-16	3	2	3	3	3	3	1	3	3	3	1	3	3
6	The [01] Requirements Management (REQM) Plan documents project requirements.	02-01-00-001-07-28-16	3	1	3	3	2	3	1	3	3	3	1	3	
7	REQM Project processes for interpretation, agreement, and commitment to management and technical requirements.	02-01-00-001-07-28-16	3	1	3	3	2	3	1	3	3	3	1	3	
8	Project approach to requirements documentation, traceability, and addressing changes.	02-01-00-001-07-28-16	3	1	3	3	2	3	1	3	3	3	1	3	
9	Reviews and other mechanisms to ensure that inconsistencies between requirements, project plans, and work products are identified, tracked, and resolved.	02-01-00-001-07-28-16	3	1	3	3	2	3	1	3	3	3	1	3	
10	The project schedule baseline is captured in Appendix B and will be updated on a weekly basis, or as necessary to reflect current data. In order to maintain an efficient project schedule.	02-01-00-001-07-28-16	3	1	3	3	2	3	1	3	3	3	1	3	

**Table 79: S1 Evidence Item (Portion) from Case Study Database**

The evidence items of the case study database used to support the definition of S1’s in this case is seen in Table 79 above. The nine tasks identified in this case represent the S1’s to a VSM. The supporting evidence item shown scored ‘3’ occurred 9 times. The Case Study Database (CSD) contains all the case evidence for all the Systems and Channels, only a portion is shown here for convenience. The evidence proves that for this case S1’s can be represented in the VSM.

**System Two Development from the CSR database**

The System Two can best be described as the working relationship between the individual tasks leads and the interaction within the project lead. The System Two contained the anti-oscillatory action between the S1s. Definition of the tasks of the task leaders was described. S2 definitions and identifiers are shown below in Table 80:

System	Definition(s)	Identifiers
S2	Anti-oscillatory regulatory, input filter to S3, (Beer, 1981)	Coordinator, preventing oscillations (Beer, 1981, p. 160).
	Divisional/Corporate regulatory (Beer, 1981, p. 157)	Elaborate interface between S1 and S2 (Beer, 1981).
	Metasystem subsuming all S1's (Beer, p. 172, 1981)	Monitors what S1 does (Beer, 1981).
		Input filter to S3 (Beer, 1981).
		Services S1 and is not a command channel (Beer, 1979).
		Not routine services, but anti-oscillatory (Beer, 1979).
		Must be recognized by the observer (Beer, 1979, p.189).
		"To avoid explosion is minimally to constrain freedom" (Beer, 1979, p. 190).
		Maintain coordination among S1's (Keating, et al, 2012).
		Promote system efficiency amongst S1s (Keating, et al, 2012).
		Identify and manage emergent conflict between S1s (Keating, et al, 2012).
		Identify system integration issues for system level resolution (Keating, et al, 2012).

**Table 80: S2 Definitions/ Identifiers**

This anti-oscillatory interaction usually occurred at the weekly project meetings, at a PMR, or through email discussions. The function of System Two was to prevent oscillation between the System One's with respect to resources and other needs. The project lead sent an aggregated task proposal/estimate to the sponsor. The sponsor worked with the project lead to accept and approve the estimate intended to be funded. The agreement of this interaction was accomplished when the sponsor sent the task planning letters and acceptance of this tasking letter

by the project and organization was confirmed. The funding document was the actual dollars sent to the project for utilization. As the project team broke down the project into identifiable tasks, from the now aggregated estimate which was modified by the sponsor, the government tasks leads used their previous estimates to baseline schedules, funding allocations, contract support, etc. The project lead accepts the tasking and determined tasking to be as per funding. The discussions on funding differences were typically between the task leads and the project lead along with the BFM (others were included both for learning and to be informed). If the problem wasn't resolved between the S1's at the S3 level, the problem would have risen up to the S5 level for resolution.

The anti-oscillatory functions occurred in the weekly meeting with the sponsors, the task leads and project lead. This was the occasion where the tasks leads got together and discussed resource needs and challenges. The bargaining of resources also occurred during this period. This combination of management and the sponsors within the project's S2 area of functionality is different than would be expected in the VSM. The project lead oversees the multiple project tasks but it is the task leads that report to the sponsor on the status and updates of the tasks during working meetings. This illustrated a merging of the S3-S4-S5 responsibilities.

### **System Three and Three\* Development from the CSR database**

The System Three functionally was comprised of the task leads, the project lead, the BFM, contractor team lead, and the sponsor. This functional role was exercised during weekly meetings, government oversight functions, and contract negotiations. The “here-and-now” (Beer, 1981) of the current tasking and associated schedules are discussed. Resources were identified, tracked, and reported during these System Three level meetings and the information was then processed for distribution amongst the task leads and their team members, usually sent via email.

The System Three and There\* contained the first level management of the project and also the monitoring and control functions for the project. Definition of the S3 and S3\* tasks were described in the dissertation earlier and are shown below in Tables 82 and Table 83 respectively:



System	Definition(s)	Identifiers
S3	Provides interface with S4 and S5 structures and controls that establish rules, resources, rights, and responsibilities of S1 (Beer, 1982)	Highest level of autonomic magnet and the lowest level of corporate management of the systems in focus (Beer, p. 175, 1981).
	Operative management (Ríos, 2012)	Transmitter of policy and special instructions to the divisions/S1s (Beer, 1981, p. 176).
	Highest level of autonomic management (Beer, 1981, pp. 175- 176)	Recover of information of the internal environment; sends information upwards and downwards; only recovery of information upward from S2 (Beer, 1981, p. 176).
	Lowest level of corporate management (Beer, 1981)	Aware of what's going on inside the firm now (Beer, 1979, p. 202).
	Govern the stability of the internal environments of the project (Beer, 1981)	Manage the 'here and now' of the organization (Ríos, 2012).
	Transmitter of policy/special instructions to the divisions (Beer, 1981)	Describing the channels between S4 and S3 (Ríos, 2012).
	Tracer of information of internal environment: metasystem controller downward, senior filter of information upward	Facilities resources communications between representatives form S3 and S4.
	Handles S2 information circuits (Beer, 1981)	Methodological and functional communications trough models and tools (Ríos, 2012).
		Setting goals.
		Negotiating resources.
		Accountability procedures.
		Marketing's, sales, human resources, productivity and quality, production and operation, engineering, accounting, budgeting (Ríos, 2012).
		Handles divisional interactions (Beer, 1981).
		This is where the financial director, a production director, and as sale director would operate. "Each of them is setting out to integrate the work foot he respective divisional managers" (Beer, 1979, p. 202) synergy policies.
		Operational planning and control for ongoing system performance (Keating, et al, 2012).
		Interprets and implements policies from S5, Interfaces with S4 to redesign operation in response and identification of environmental changes (Keating, et al, 2012).

**Table 81: S3 Definition/Identifiers**

VSM		
System	Definition(s)	Identifiers
S3*	Audit channel (Beer, 1981)	Highest level of autonomic magnet and the lowest level of corporate management of the systems in focus (Beer, 1981, p. 175).
		Transmitter of policy and special instructions to the divisions/S1s (Beer, 1981, p. 176).
		Recover of information of the internal environment; sends information upwards and downwards; only recovery of information upward from S2 (Beer, 1981, p. 176).
		Monitor Subsystems and system level performance (Keating, et al, 2012).
		Identify and analyze deviant performance, unexpected crisis, and operational conditions and trends (Keating, et al, 2012).

**Table 82: S3\* (Star) Definitions/Identifiers**

System Three provided the project lead reports based on templates provided by the project lead. The System Three area is where collaboration and bargaining between the S1's was managed. System Three\* were internal audits and PMRs. The internal audits were initiated by organizational policy and procedure reviews which looked to the project leads to provide artifacts for their defense. The PMR initiated by the program sponsors were an effort to ensure tasking was being performed as agreed upon in the task planning letters, representing a S3\* function. Project leads also performed unscheduled visits to the work areas to monitor project activities, another S3\* function. Similar requests for statuses that were not routine were identified in emails from the project lead to the team members. Evidence Items that support the S3 and S3\* of the VSM model are shown below in Tables 84:

Item	Evidence Description	Data Source Code	S1	S2	S3	S3*	S4	S5	C1	C2	C3	C4	C5	C6	Alg
1	The project supports [02]. Deliverable: JITC approved facility/products and enterprise engineering support/related documentation.	02-01-00-001-07-28-16	1		3		1	3	1	1	1	1	1		
3	Project team identified hierarchically: PM [01], BFM [02],[3]-[11].	02-01-00-001-07-28-16	3	1	3	3	2	3	1	3	2	2			
4	PMP, Configuration plan, quality assistance plan, and risk management plan identified as part of PMP.	02-01-00-001-07-28-16	3	1	3	3	2	3	1	3	3	3		3	
5	The [01] Requirements Management (REQM) Plan documents project requirements.	02-01-00-001-07-28-16	3	2	3	3	3	3	1	3	3	3	1	3	3
6	REQM Project processes for interpretation, agreement, and commitment to management and technical requirements.	02-01-00-001-07-28-16	3	1	3	3	2	3	1	3	3	3	1	3	
7	Project approach to requirements documentation, traceability, and addressing changes.	02-01-00-001-07-28-16	3	1	3	3	2	3	1	3	3	3	1	3	
8	Reviews and other mechanisms to ensure that inconsistencies between requirements, project plans, and work products are identified, tracked, and resolved.	02-01-00-001-07-28-16	3	1	3	3	2	3	1	3	3	3	1	3	
9	The project schedule baseline is captured in Appendix B and will be updated on a weekly basis, or as necessary to reflect current data. In order to maintain an efficient project schedule.	02-01-00-001-07-28-16	3	1	3	3	2	3	1	3	3	3	1	3	
10	Task duration will be no less than 1 week (40 hours) for any project with a weekly update requirement.	02-01-00-001-07-28-16	3	2	3	3	1	3	1	3	3	3	2	3	
11	No task will extend beyond 44 days (2 months) as this will cause a loss of fidelity in the project schedule.	02-01-00-001-07-28-16	3	2	3	3	1	3	1	3	3	3	2	3	

**Table 84: Evidence Items for S3 and S3\* (Portion) from the Case Study database**

A portion of the data is used for information purposes. The data is sorted based on the System or Channel. The event shown was scored 12 times and represents a fit into the VSM model. The Case Study Database (CSD) contains all the case evidence for all the Systems and Channels. The evidence items of the case study database used to support the definition of SS and S3\*’s in this case are seen in Table 84 above. The supporting evidence items shown scored ‘3’ occurred 10 times. The Case Study Database (CSD) contains all the case evidence for all the Systems and Channels, only a portion is shown here for convenience. The evidence proves that for this case S3 and S3\*’s can be represented in the VSM.

**System Four Development from the CSR database**

The System Four was the most difficult to identify. In talking with the team members, most felt they got their strategic views from the program office/sponsor. This was reflected in the

weak identity the group had as project team within this organization. Within a competency aligned organization the project team, based on competency assignments, are members of a competency as well that provided human resources to the projects. In talking with [00] the project lead, the strategic planning went beyond the future phase and into conversations with vendors and other organizational members. The project lead admits that the team barely has time to complete current tasks and feels as though he runs around 'putting fires out with a fire hose'. Task leads discussed future planned efforts formally but strategic tasking was more of an informal process at this time. The project lead and task leads merged the task of developing a model of the status of the projects to be passed up to management and associated customers/stakeholders that warranted the reporting. The discussion that did occur occurred between the project lead and task leaders (and any potential stakeholders) were at best referred to as informal discussions. The System Four should contain the forward looking area of the project. Definition of the tasks of the S4 system was described earlier in the dissertation. System Four definitions and identifiers are shown below in Table 84:

System	Definition(s)	Identifiers
S4	Development directorate of the organization (Beer, 1981, p. 181)	A description of management and individual's purpose is S4 (Ríos, 2012).
	Detecting and conveying changes and needs determined by the evolution of the environment and conveying this to the interior organization (Ríos, 2012)	Explicit descriptions of activities that each individual does for S4.
	Strategic management (Ríos, 2012)	Means that organization supports S4 efforts.
	Elements which look outward to the environment to understand how the organization needs to adapt to remain viable (Beer, 1981)	Simulation models, tools for carrying out prospective studies, methods employed to explore alternative decisions, decision area (Ríos, 2012).
	The model S4 use helps to facilitate the examination of corporate plans on the indefinite time-base which invalidates so many static models of the corporate economy (Keating, et al, 2012)	Elements or physical visualizations of past/present/modeled data for decision making (Ríos, 2012).
		Environment areas to account for include: commercial, social, demographic, technological, political, legal, economic, ecological, and educational (Ríos, 2012).
		Sensor, transducers channels of communications analysis of how to make these work (Ríos, 2012).
		Awareness of how data/information is captured viewed/presented and associated characteristics (Ríos, 2012)
		Review of vision, mission, objectives, business model, profitable growth areas, new challenges, and chances for transformation as desired, expansions. Etc. (Ríos, 2012).
		Information switch between S3/S5 filtered (Beer, 1981).
		Foster strategic learning, development, and transformation (Keating, et al, 2012).
		Maintain environmental scanning, analysis, and interpretation (Keating, et al, 2012).
		Maintain models of the systems for other subsystems and the environment; guides system transformation; identify system trends and patterns (Keating, et al, 2012).

**Table 84: S4 Definition/Identifiers**

Item	Evidence Description	Data Source Code	S1	S2	S3	S3*	S4	S5		C1	C2	C3	C4	C5	C6	Alg
67	Team works off the Integrated Master Schedule (IMS) from the program office [1] other groups work off this same schedule. Task that are funded and worked are reported on weekly.	02-16-02-006-08-12-16	3	2	3	3	3	3		3	3	3	3	3	3	3
68	Spend Plan indicates which tasks are funded and are tasks from the IMS that [1] controls	02-16-02-006-08-12-16	3	2	3	3	3	3		3	3	3	3	3	3	3
74	Stakeholders are sponsor, team, ccustomers	02-16-02-006-08-12-16	3	1	3	1	3	3		2	3	2	2	1	3	
77	IMS drives all actions and tasks...PL talk directly with Sponsor teams...PL mitigates	02-16-02-006-08-12-16	3	2	3	2	3	3		3	3	3	3	3	3	3
81	Monitoring of projects through meetings, PMR, and internal competency audits of processes and procedures	02-16-02-006-08-12-16	3	2	3	3	3	3		2	3	3	3	3	3	3
82	Again IMS holds tasking that gets into spend plans as tasking to the project....their portion is a portion of an overall effort maintain by the project's sponsor	02-16-02-006-08-12-16	3	2	3	3	3	3		2	3	3	3	3	3	3
83	Sponsor weekly meeting going done IMS schedule discussing items and adjusting issues as permitted	02-00-01-007-08-15-16	3	2	3	3	3	3		2	3	3	3	3	3	3
84	Project team is updating org chart for the sponsor due to more new people on the project	02-00-01-007-08-15-16	3	1	3	1	3	2		1	3	3	3	1	2	
85	Sponsor changed the priority lists of task and was advising everyone....later observer asked PL who was taking minutes and he mentioned sponsor took overall notes and sends out the minutes...individuals at the meeting appear to take notes related to their tasks only	02-00-01-007-08-15-16	3	1	3			3	3		1	2	1		1	3

**Table 85: S4 Evidence Item (portion) form the Case Study Database**

The evidence items of the case study database used to support the definition of S4’s in this case is seen in Table 85 above. The supporting evidence items that scored ‘3’ occurred more than 10 times. The Case Study Database (CSD) contains all the case evidence for all the Systems and Channels, only a portion is shown here for convenience. The evidence proves that for this case S4’s can be represented in the VSM, but the weak separation of S3-S4-S5 must be noted.

**System Five Development from the CSR database**

The System Five identity of the project centered on the project lead and the BFM which had final negotiating authority over the tasking the project accepted. The tasks leads primarily associated with the S1 were seen represented in the S5 area as well. The sponsor informally dictated the name of the project based on the way estimates were routed up the government channels for approval and provided the source of funding. The reverse path was similar but was

not exactly the same based on the requirements and priorities determined at each level of appropriation. The funding document was the determining factor as to what the project was: the funding document matched requirements of funded tasking. The project lead maintained the final vote for project related decisions within the organization and also was responsible for all the processes, data calls, and organizational procedures to be followed. The project was autonomous, but not purely. Organizational management requirements occurred and needed to be passed down appropriately to the team. The System Five contained the project's identify and final decision point. Definition of the S5 tasks was described earlier in the dissertation. System Five definitions and identifiers are shown below in Table 86:

VSM		
System	Definition(s)	Identifiers
S5	Responsible for policy and decisions (Beer, 1981)	Looks at needs of divisions and may sacrifice resources for the greater good (Beer, 1981, p. 160).
	"Collegiate authority" (Beer, 1981, p. 154)	Operations room environment available (Beer, 1981) (Ríos, 2012).
	Provides the identity of the organization (Beer, 1981)	Provides Identity of the organization (Beer, 1981).
	Responsible for achieving an equilibrium between the present functioning of the organization and its preparation for the future (Ríos, 2012)	Resources that actually make up S5 identified (Ríos, 2012).
	Creates policy decisions within the organization as a whole to balance demands from different organizations and provide direction to the organizational as a whole (Beer, 1982)	Procedures to communicate strategic plan/identity to the organization (Ríos, 2012).
	Normative management (Ríos, 2012)	Are channels in place to communicate S5 needs, sensors, emergency access to S5 i.e. functional (Ríos, 2012).
		Interaction between S3/S4 with S5 to maintain equilibrium/resolve S3/S4 issues (Ríos, 2012).
		Develop system policy and direction (Keating, et al, 2012).
		Strategic goals/objectives written (Ríos, 2012).
		Monitors vertical command axis for obeying instructions (Beer, 1981, p. 159).
		Formal declaration of vision, mission, purpose (Ríos, 2012).
		Represent and communicate the system to external entities; process input/outputs forms other subsystems; establish system policy and strategic direction (Keating, et al, 2012).
		Propagate system identity; maintain and propagate mission/vision/identity (Keating, et al, 2012).
		Balance systems focus between S3 and S4 (now and future) (Keating, et al, 2012).

**Table 86: S5 Definition/Identifiers**



The evidence items of the case study database used to support the definition of S5 in this case is seen in Table 86 above. The supporting evidence items that scored '3' occurred more than 10 times. The Case Study Database (CSD) contains all the case evidence for all the Systems and Channels, only a portion is shown here for convenience. The evidence proves that for this case S5 can be represented in the VSM.

### **Channel Development from the CSR database**

The next phase dealt with modeling the communication channel of the project to the VSM. The communication channels in the VSM are the elements that connect both the diverse functions specified in the VSM and the organization with its environment(s) (Ríos, 2012). The channels provide the equilibrium, balance or homeostasis of the internal environment of the system in view. The six primary channels of the VSM can be characterized as follows (Ríos, 2012, p 61):

1. Channel One – C1 – Channel connecting and absorbing variety between the environments of each elementary operational unit.
2. Channel Two – C2 – Channel connecting the various elemental operations (operational units making up System One).
3. Channel Three – C3 – Corporate intervention channel (System Three-System One).
4. Channel Four – C4 – Resources bargaining channel (System Three – System One).
5. Channel Five – C5 – Anti-oscillatory channels (Co-ordination) (System Two).
6. Channel Six – C6 – Monitor channel (Auditor).
7. Algedonic Channel – Transmits alert signal concerning any event or circumstance that could jeopardize the organization. Travels straight to the top through existing links.

The six primary VSM communication channels can be seen in Figure 37 below:

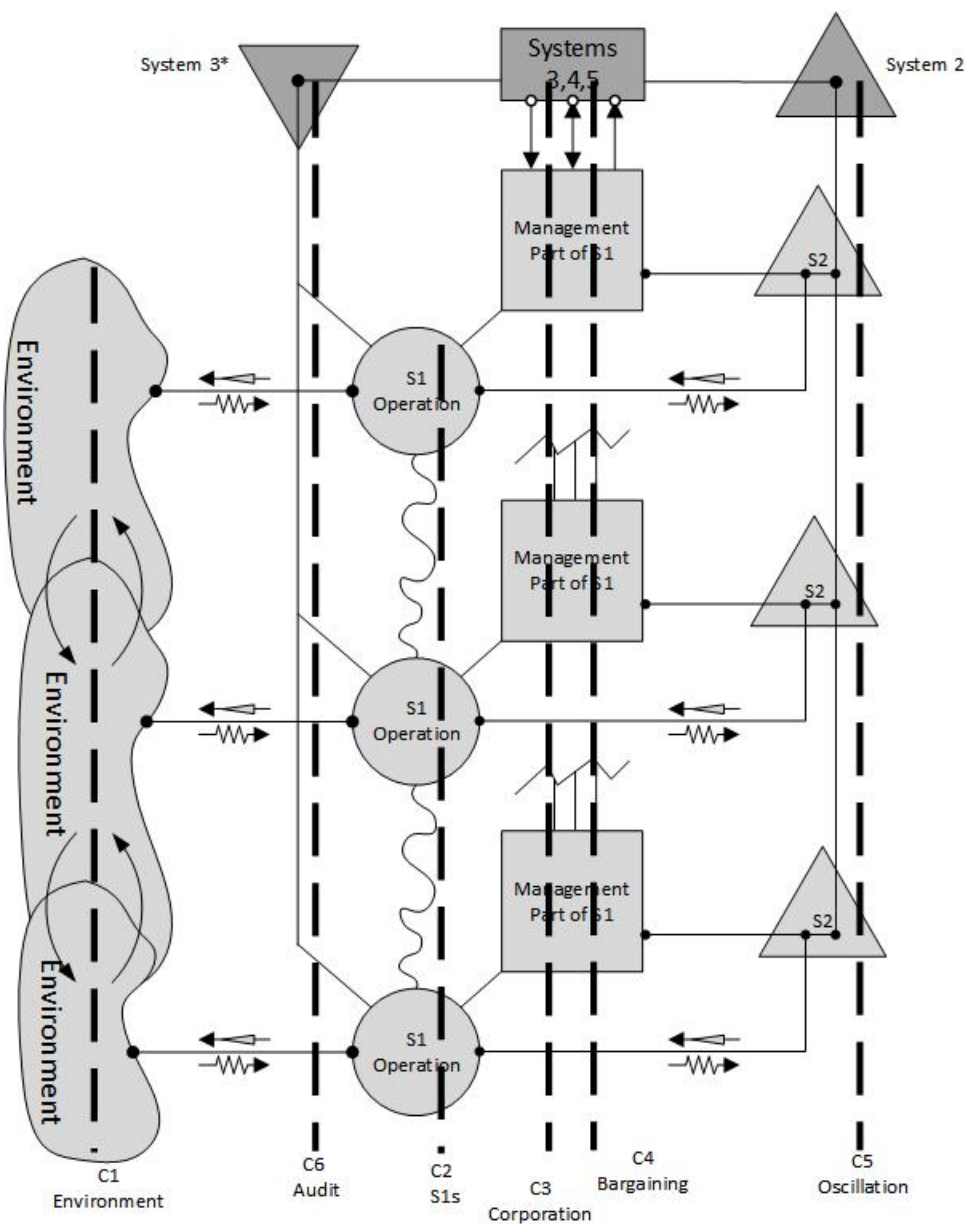

**Figure 37: The Six Primary Communication Channels of the VSM**

The case study database and the available artifacts provided were examined to develop and validate the use of the six primary channels of the VSM. The project lead provided a

hierarchical diagram of how the project was organized and can be seen in the PMP. The channel development used the communication channel definitions and identifiers used in the dissertation earlier. The analysis of the evidence items were performed similarly to the Systems development and used to identify the models communication channels. The next sections summarize the linkage between Definition/Identifiers to the case study database evidence items.

### **Channel One Development from the CSR database**

Analyzing for elements of Channel One, the researcher looked for communication channels connecting and absorbing variety between the environments of each elementary operational unit. The case study database was analyzed for themes that would support the presence of C1's in this case. The following case study data shown in Table 87 supports the presence of the C1's:

Item	Evidence Description	Data Source Code
55	When task leads have issues they can't handle they bring up to meeting to discuss	02-00-02-005-08-11-16
67	Team works off the Integrated Master Schedule (IMS) from the program office [1] other groups work off this same schedule. Task that are funded and worked are reported on weekly.	02-16-02-006-08-12-16
68	Spend Plan indicates which tasks are funded and are tasks from the IMS that [1] controls	02-16-02-006-08-12-16
76	CASREPS and 301 tickets are another feedback path. Positive feedback may come from an occasional sponsor good word	02-16-02-006-08-12-16
77	IMS drives all actions and tasks...PL talk directly with Sponsor teams...PL mitigates	02-16-02-006-08-12-16
86	Sponsor discussing customer feedback and requirements request while trying to validate them to their IMS tasking schedule; Sponsor asked for feedback on some tasks; Appeared to be working level discussion for the project where the sponsor was like the PL	02-00-01-007-08-15-16
87	Appeared to be working level discussion for the project where the sponsor was like the PL	02-00-01-007-08-15-16
88	Sponsor seemed to ask allot of question as to the status of events as there appeared to be no written updates ..perhaps this is where the updates occurred...	02-00-01-007-08-15-16

**Table 87: C1 Evidence Items from Case Study Database (Portion)**

The case reflected where the contractors supporting multiple task leads communicated and worked together to supported the overall project goals. Each with an autonomous purposed based on tasking; each still participated in the overall project. The evidence supports the presence of C1 channels as defined by the VSM.

### **Channel Two Development from the CSR database**

Analyzing for elements of Channel Two, the researcher looked for Communications Channel connecting the various operational (S1s) units. Communications between the S1's usually occurred at the weekly meetings. Minutes were generated and distributed. Each of the weekly meetings discussed current resources used and planned resources for all nine tasks within the project. BFM and contractor provided financial data was reviewed to ensure work progress as

expected along with expenditures. Discussion of shared resources occurred often as the overall project was operating on limited resources. The case study database was analyzed for themes that would support the presence of C2's in this case. The following case study data shown in Table 88 below supports the presence of the C2's:

Item	Evidence Description	Data Source Code
4	Project team identified hierarchically; PM [01], BFM [02],[3]-[11].	02-01-00-001-07-28-16
5	PMP, Configuration plan, quality assistance plan, and risk management plan identified as part of PMP.	02-01-00-001-07-28-16
6	The [01] Requirements Management (REQM) Plan documents project requirements.	02-01-00-001-07-28-16
7	REQM Project processes for interpretation, agreement, and commitment to management and technical requirements.	02-01-00-001-07-28-16
8	Project approach to requirements documentation, traceability, and addressing changes.	02-01-00-001-07-28-16
9	Reviews and other mechanisms to ensure that inconsistencies between requirements, project plans, and work products are identified, tracked, and resolved.	02-01-00-001-07-28-16
10	The project schedule baseline is captured in Appendix B and will be updated on a weekly basis, or as necessary to reflect current data. In order to maintain an efficient project schedule.	02-01-00-001-07-28-16
11	Task duration will be no less than 1 week (40 hours) for any project with a weekly update requirement.	02-01-00-001-07-28-16
12	No task will extend beyond 44 days (2 months) as this will cause a loss of fidelity in the project schedule.	02-01-00-001-07-28-16
13	Level of Effort tasks (such as Project Management, Acquisition Management, and Financial Management) will not be applied to the project schedule.	02-01-00-001-07-28-16
14	Cost will be captured and managed via numerous tools:	02-01-00-001-07-28-16
15	Reimbursable cost will be managed via N-ERP.	02-01-00-001-07-28-16
16	Direct Cite cost will be managed via Monthly Status Reports (MSRs) from sub-contractors and Wide Area Workflow (WAW).	02-01-00-001-07-28-16
17	Overall cost performance will be monitored via the appropriate Earned Value Management (EVM) metrics and variances.	02-01-00-001-07-28-16
18	The [01] Quality Assurance (QA) Plan documents the QA management activities that are in place throughout the project life cycle to attain satisfaction of project quality objectives and requirements. By ensuring that staff and management have objective insight into project process performance and implementation of evolving work products and services, necessary corrective action can be taken in a timely manner to prevent significant project impacts. Also, collection of project process-related experiences and key artifacts can help to improve the commands set of organizational standard processes.	02-01-00-001-07-28-16

**Table 88: C2 Evidence Items from the Case Study Database (Portion)**

The case evidence showed the task leads routinely gathering for meetings and discussing operational requirements. The use of the Integrated Master Schedule (IMS) that was hosted by the sponsor demonstrated the organization interaction and accountability of each of the task within the project. The Project lead oversaw the operational milestones and metric developments of the individual task in support of the sponsor's requirements. The evidence supports the presence of C2 channels as defined by the VSM.

### **Channel Three Development from the CSR database**

Analyzing for elements of Channel Three, the researcher looked for communication primarily between the S3 and S1's which provided project updates and examined the communications which helped define the management style used within this channel. The task leads had discussions concerning their task at the weekly minutes whose minutes were recorded and distributed. The task leads had group meetings with their team and daily working discussions that helped capture the data for reporting. The weekly meeting format was used to brief all on the project team members. Often the discussions of an ongoing task were discussed with the sponsor, project lead, and the task leads concurrently. The S3 provided the task leads insight into the organization culture and decision making ongoing within the support areas of the organization; for example, contracts areas, management's project priorities, submission deadlines, training opportunities, etc. The task leads would provide status reports and metrics to be used by management. The case study database was analyzed for themes that would support the presence of C3's in this case. . The following case study data shown in Table 89 below supports the presence of the C3's:

Item	Evidence Description	Data Source Code
2	The project supports ISEA services, JITC testing, overall engineering and support for [01] (and anything related) [02].	02-01-00-001-07-28-16
4	Project team identified hierarchically; PM [01], BFM [02],[3]-[11].	02-01-00-001-07-28-16
5	PMP, Configuration plan, quality assistance plan, and risk management plan identified as part of PMP.	02-01-00-001-07-28-16
6	The [01] Requirements Management (REQM) Plan documents project requirements.	02-01-00-001-07-28-16
7	REQM Project processes for interpretation, agreement, and commitment to management and technical requirements.	02-01-00-001-07-28-16
8	Project approach to requirements documentation, traceability, and addressing changes.	02-01-00-001-07-28-16
9	Reviews and other mechanisms to ensure that inconsistencies between requirements, project plans, and work products are identified, tracked, and resolved.	02-01-00-001-07-28-16
10	The project schedule baseline is captured in Appendix B and will be updated on a weekly basis, or as necessary to reflect current data. In order to maintain an efficient project schedule.	02-01-00-001-07-28-16
11	Task duration will be no less than 1 week (40 hours) for any project with a weekly update requirement.	02-01-00-001-07-28-16
12	No task will extend beyond 44 days (2 months) as this will cause a loss of fidelity in the project schedule.	02-01-00-001-07-28-16
13	Level of Effort tasks (such as Project Management, Acquisition Management, and Financial Management) will not be applied to the project schedule.	02-01-00-001-07-28-16
14	Cost will be captured and managed via numerous tools:	02-01-00-001-07-28-16
15	Reimbursable cost will be managed via N-ERP.	02-01-00-001-07-28-16
16	Direct Cite cost will be managed via Monthly Status Reports (MSRs) from sub-contractors and Wide Area Workflow (WAW).	02-01-00-001-07-28-16
17	Overall cost performance will be monitored via the appropriate Earned Value Management (EVM) metrics and variances.	02-01-00-001-07-28-16

**Table 89: C3 Evidence Items from the Case Study Database (Portion)**

The evidence shows the team regularly met with other team members to bargain for resources. The project had multiple tasks that relied on the skillsets of the overall team. The project lead oversaw the bargaining of resources to ensure that the tasks remained within scope. Deviation that was required meant the project lead and to renegotiated with the sponsor for



funding or realigning funded requirements. The evidence supports the presence of C3 channels as defined by the VSM.

### **Channel Four Development from the CSR database**

Analyzing for elements of Channel Four, the researcher looked for areas where resource bargaining occurred between the S1's and S3's. With changes in schedule frequent, the need for resources and the availability of resources changed. The project lead identified the lack of resources available to the multiple projects. The lack of skillset available to the project from the organization was identified and understood by the sponsor. The S1's worked the S3's to ensure S5 knew what resources were needed and the impact to the individual tasks. The bargaining and sharing of resources was a regular event for the tasks during their weekly meetings. The case study database was analyzed for themes that would support the presence of C4's in this case. . The following case study data shown in Table 90 below supports the presence of the C4's:

Item	Evidence Description	Data Source Code
18	The [01] Quality Assurance (QA) Plan documents the QA management activities that are in place throughout the project life cycle to attain satisfaction of project quality objectives and requirements. By ensuring that staff and management have objective insight into project process performance and implementation of evolving work products and services, necessary corrective action can be taken in a timely manner to prevent significant project impacts. Also, collection of project process-related experiences and key artifacts can help to improve the commands set of organizational standard processes.	02-01-00-001-07-28-16
19	The IPT Lead is responsible for ensuring proper communication and stakeholder engagement in the [01] IPT. This includes identifying, communicating, and coordinating with the relevant stakeholders listed in this PMP who participate in, or are affected by specific IPT activities. The IPT Lead is responsible for developing a comprehensive plan that outlines the appropriate timing and messaging for engaging stakeholders in key decisions, activities, and development milestones. This is dependent upon a thorough stakeholder identification and analysis of their roles and responsibilities, interests, and any potential for obstacles or resistance.	02-01-00-001-07-28-16
35	Command IA Compliance: Details: IA lead is responsible for providing technical judgment of the system's compliance with stated requirements, identifying and assessing the risks associated with operating the systems for various fielded [01] products. Deliverables: - Conduct oversight and analyses of required IAVA/B patch management for fielded [01] accredited systems; FISMA Reviews and Updates; IA Package Reviews/Updates (Risk Management Framework (RMF)); Support/review Engineering Change Request (ECR) activities;VRAM Compliance Reporting	02-01-00-003-07-28-16
36	Command IA Compliance Details: Augment Govt IA activities. Support is provided for various [01] products.	02-01-00-003-07-28-16
37	Command ISEA Lead: Details: ISEA Lead oversees all ISEA related activities for fielded [01] systems ensuring they are planned and executed as required. Deliverables: ULSS Package Creation/Reviews/Updates; SOVT Development/Review -Site Support/Assistance; ISEA Spare Procurement; Logistics Support; Shipping/Receiving/Warehouse Storage	02-01-00-003-07-28-16
38	Command ISEA Remedy Help Desk: Details: Monitor, update, open, analyze, prioritize trouble tickets. Continue to monitor, analyze, and revise any current processes documents associated with efforts. Deliverables: Quarterly Metric Reports (Trouble Tickets, CASREPS); Technical Assistance/Help Desk Support; Ensure Command Remedy database for maintenance actions are documented and updated weekly; Review and approve monthly reports summarizing support actions conducted and documented within Remedy and SAILOR	02-01-00-003-07-28-16
39	Command ISEA Remedy Help Desk: Details: Monitor, update, open, analyze, prioritize trouble tickets. Continue to monitor, analyze, and revise any current processes documents associated with efforts. Deliverables: - Quarterly Metric Reports (Trouble Ticket: Details: Augment Govt Remedy Help Desk efforts	02-01-00-003-07-28-16
40	Command Fleet Support: Details: Provide Fleet Support, Distant Support, On-site assistance. Monthly review of trouble tickets, CASREPS, general system issues. Deliverables: CASREP reporting; Trip Reports (as applicable)	02-01-00-003-07-28-16
41	Enterprise Licenses: Details: Augment Govt Fleet Support activities, Distant Support, On-site assistance.	02-01-00-003-07-28-16
42	Command Laboratory: ELA Cost (Cisco, Microsoft, VMWare): Details: Fee for customer circuit connectivity for testing with command [01]	02-01-00-003-07-28-16
43	Command Windows 10 Implementation: Replace Windows 7 clients with a customer Windows 10.	02-01-00-003-07-28-16
44	Program office and project team in meeting with other stakeholders; discussed project issues; contract items; scheduled items and changes/updates; documentation updates; open action items discussed.	02-01-00-004-07-28-16

**Table 90: C4 Evidence from the Case Study Database (Portion)**

The evidence showed the need for resources for multiple tasks coming in from the Help desk. This need was presented in the weekly meetings. The weekly meetings was where the bargaining of resources often occurred to ensure the project lead was always aware of the task leads needs and negotiated decision on resources. The evidence supports the presence of C4 channels as defined by the VSM.

### **Channel Five Development from the CSR database**

Analyzing for elements of Channel Five, the researcher looked for areas where S2's functional areas were working to reduce conflicts and other project level oscillations. The presentation of schedules and baselines (IMS) helped to ensure all the task members were aware of where the resources were initially planned. Conflicts or changes that affected another task were often brought up early and mitigated primarily in weekly meetings. The case study database was analyzed for themes that would support the presence of C5's in this case. . The following case study data shown in Table 91 below supports the presence of the C5's:

Item	Evidence Description	Data Source Code
18	The [01] Quality Assurance (QA) Plan documents the QA management activities that are in place throughout the project life cycle to attain satisfaction of project quality objectives and requirements. By ensuring that staff and management have objective insight into project process performance and implementation of evolving work products and services, necessary corrective action can be taken in a timely manner to prevent significant project impacts. Also, collection of project process-related experiences and key artifacts can help to improve the commands set of organizational standard processes.	02-01-00-001-07-28-16
19	The IPT Lead is responsible for ensuring proper communication and stakeholder engagement in the [01] IPT. This includes identifying, communicating, and coordinating with the relevant stakeholders listed in this PMP who participate in, or are affected by specific IPT activities. The IPT Lead is responsible for developing a comprehensive plan that outlines the appropriate timing and messaging for engaging stakeholders in key decisions, activities, and development milestones. This is dependent upon a thorough stakeholder identification and analysis of their roles and responsibilities, interests, and any potential for obstacles or resistance.	02-01-00-001-07-28-16
35	Command IA Compliance: Details: IA lead is responsible for providing technical judgment of the system's compliance with stated requirements, identifying and assessing the risks associated with operating the systems for various fielded [01] products. Deliverables: - Conduct oversight and analyses of required IAVA/B patch management for fielded [01] accredited systems; FISMA Reviews and Updates; IA Package Reviews/Updates (Risk Management Framework (RMF)); Support/review Engineering Change Request (ECR) activities;VRAM Compliance Reporting	02-01-00-003-07-28-16
36	Command IA Compliance Details: Augment Govt IA activities. Support is provided for various [01] products.	02-01-00-003-07-28-16
37	Command ISEA Lead: Details: ISEA Lead oversees all ISEA related activities for fielded [01] systems ensuring they are planned and executed as required. Deliverables: ULSS Package Creation/Reviews/Updates; SOVT Development/Review -Site Support/Assistance; ISEA Spare Procurement; Logistics Support; Shipping/Receiving/Warehouse Storage	02-01-00-003-07-28-16
38	Command ISEA Remedy Help Desk: Details: Monitor, update, open, analyze, prioritize trouble tickets. Continue to monitor, analyze, and revise any current processes documents associated with efforts. Deliverables: Quarterly Metric Reports (Trouble Tickets, CASREPS); Technical Assistance/Help Desk Support; Ensure Command Remedy database for maintenance actions are documented and updated weekly; Review and approve monthly reports summarizing support actions conducted and documented within Remedy and SAILOR	02-01-00-003-07-28-16
39	Command ISEA Remedy Help Desk: Details: Monitor, update, open, analyze, prioritize trouble tickets. Continue to monitor, analyze, and revise any current processes documents associated with efforts. Deliverables: - Quarterly Metric Reports (Trouble Ticket: Details: Augment Govt Remedy Help Desk efforts	02-01-00-003-07-28-16

**Table 91: C5 Evidence from the Case Study Database (Portion)**

The potential for oscillation between the various tasks existed due to a shortage of resources. The project lead, task leads, and sponsors recognized this and were the focus of the weekly meetings. The project team worked off the sponsor's IMS to ensure all team members were aware of the overall schedule. This consistent discussion and communication between the team members was needed to manage project resources.

### **Channel Six Development from the CSR database**

Analyzing for elements of Channel Six, the researcher looked for areas that the project was monitored and controlled. A big area again was during the weekly minutes. Formal audits were conducted during a Program Management Review (PMR). Internal audits of the IPT (a layer above the project team) and projects occurred (but not during this study). The project was questioned based on the auditor's team areas examined. The project lead, task lead, and BFM were primarily the ones involved in these types of audits. The case study database was analyzed for themes that would support the presence of C6's in this case. . The following case study data shown in Table 92 below supports the presence of the C6's:

Item	Evidence Description	Data Source Code
1	The project supports [02].	02-01-00-001-07-28-16
4	Project team identified hierarchically; PM [01], BFM [02],[3]-[11].	02-01-00-001-07-28-16
5	PMP, Configuration plan, quality assistance plan, and risk management plan identified as part of PMP.	02-01-00-001-07-28-16
6	The [01] Requirements Management (REQM) Plan documents project requirements.	02-01-00-001-07-28-16
7	REQM Project processes for interpretation, agreement, and commitment to management and technical requirements.	02-01-00-001-07-28-16
8	Project approach to requirements documentation, traceability, and addressing changes.	02-01-00-001-07-28-16
9	Reviews and other mechanisms to ensure that inconsistencies between requirements, project plans, and work products are identified, tracked, and resolved.	02-01-00-001-07-28-16
10	The project schedule baseline is captured in Appendix B and will be updated on a weekly basis, or as necessary to reflect current data. In order to maintain an efficient project schedule.	02-01-00-001-07-28-16
11	Task duration will be no less than 1 week (40 hours) for any project with a weekly update requirement.	02-01-00-001-07-28-16
12	No task will extend beyond 44 days (2 months) as this will cause a loss of fidelity in the project schedule.	02-01-00-001-07-28-16

**Table 92: C6 Evidence from Case Study Database (Portion)**

The PMRs and internal audits were the prime area for monitoring and control. The project leads participation and monitoring of status and reports updates during weekly meetings demonstrates further monitoring and control of the project and the associated tasks. The projects leads monitor of financial reports with the BFM is another example. The project and task leads observation of ongoing tasks by walking around and seeing for themselves the progress of ongoing work demonstrated monitoring of the project. The evidence supports the presence of C6 channels as defined by the VSM.

## **Channel Algedonic Development from the CSR database**

The algedonic channel was not very clear as the metasytem of S3, S4, and S5 were difficult to distinguish. In government organizations like this, and for this project, it was understood the project lead be held accountable for all aspects of a project. Sponsors, external stakeholders, internal support competencies, and management alike often targeted the project lead not only for problems but for data calls. Often data calls appeared to be treated as problems as they were the defense for the situation of concern. There was a channel that existed directly to the top: to the project lead.

### **Project 'T' Case Study Summary**

The adapted VSM model analysis of Project 'T' indicated it could be mapped into the VSM. As the VSM looks at viability verses optimization, for example, it can be seen that the S3, S4, and S5 appear to collapse together, perhaps due to a weakly defined S4. The six primarily communication channels existed within this project.

Project 'T' was modeled with the VSM where the S1's are shown below:

1. Fleet Support/ISEA
2. IP Trunking
3. RTMS
4. TUMS VoSIP
5. VTCoSIP
6. VCS Expressway
7. NVCS Aegis Ashore
8. Unified Capabilities
9. Government oversight of Telephony Tasks

The S5 was the functionally predominated by project lead, task leads, and BFM lead actions. The task leads of S1 worked with the project lead in the S3 functional role along with lead contractors at times. The S4 functional role was weak and difficult to distinguish as it appeared

to be rolled up into S3 and S5 type functions. An effort was made to separate the S4 functional area. The communication channel development for the project focused on the six primary channels. This project at a minimum did contain all the elements needed for a project that would be modeled by the VSM and is illustrated below in Figure 38 below:



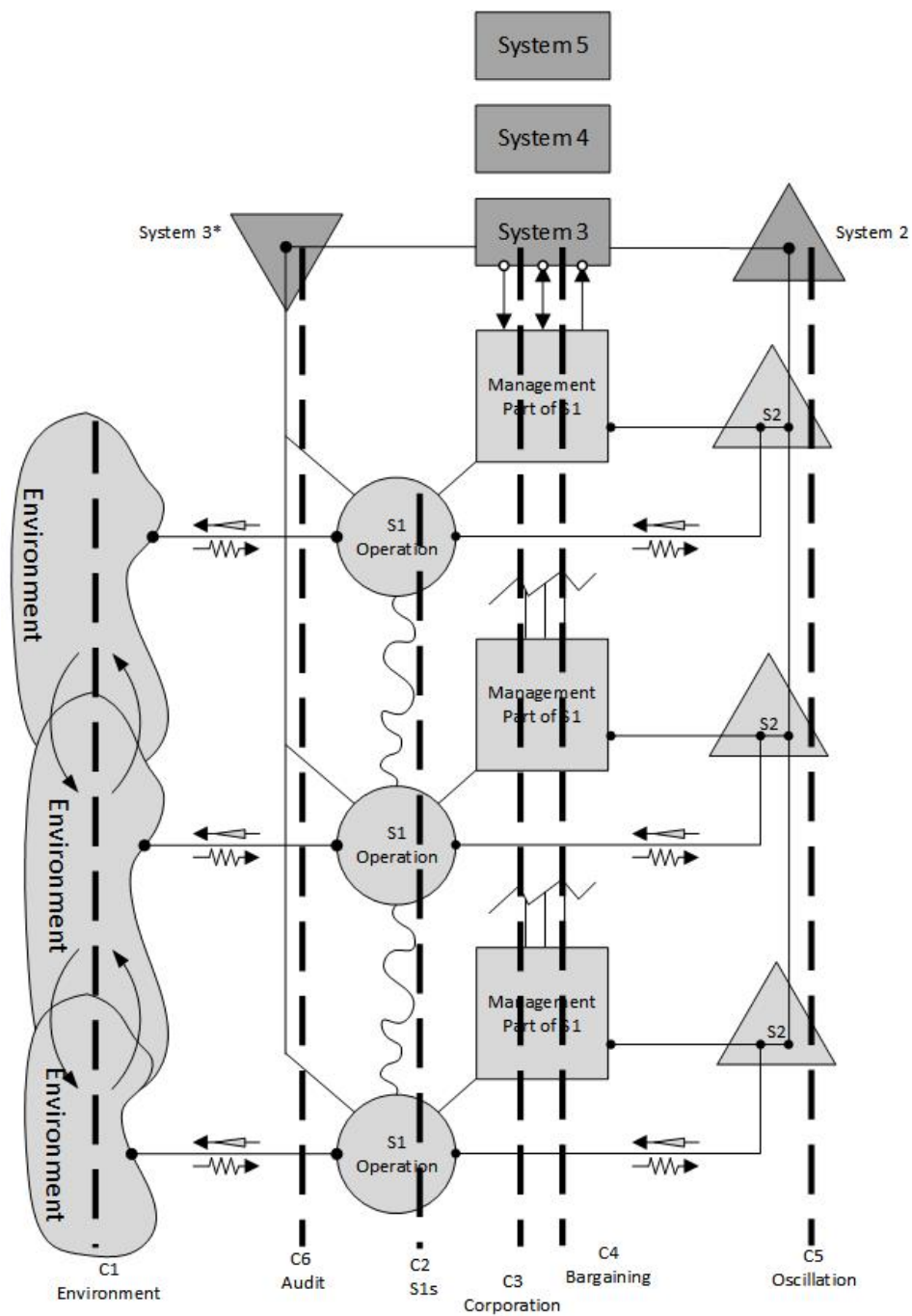

Figure 38: VSM of Project (Systems and Channels are Described in the Case Narrative)

**POTENTIAL DISCUSSION QUESTIONS**

Define the project.

What are the boundaries and the environment it will operate in?

What is the purpose of the project?

Who is the project lead?

What purpose is the project perceived to be doing as opposed to desired?

How does the project work? What effect within the project is there?

Does the project self-organize?

What feedback do you get from the customer? Who are Stakeholders? What is the Environment?

What constraints exist in the project?

What are the project outputs?

Who are the stakeholders?

How is the project organized? What are its dynamics?

Where do the internal stakeholders of the project go to for information? Where do they send their information to?

How are issues handled?

How is the project monitored?

How are decisions made within the project team?

What issues or information lead to confusion?

What outside influence does the environment have on the project?

How is 'change' handled within a project?

What are the methods of communication between the project team members and associated stakeholders?

How are strategic efforts introduced? Who participates in a strategic development effort?

## **PROJECT 'Q': CASE STUDY FEEDBACK**

Comment (1): Pg-7 doesn't appear to include the interference requirements from the S4 management area in the acceptance of funds. [11]

Action (1): There are processes and procedures to be followed inherent to the organization for the acceptance of funds. These communication channels are between the project and other command organizational 'project' areas that are beyond the scope of this case study.

Comment (2): Pg-8 strategic planning is considered 'brain-storming'? [11]

Action (2): My interpretation of the formalization of strategic planning within the project was that strategic planning was based on the outside sponsor (outside this case study) and that the level of strategic planning within the project area had no documentation or formalized methods procedures and as one team member described it as 'brain storming', it still appears to be the overarching approach as was not meant to appear offensive, but rather, an objective descriptive reflection of what actually occurs within this project.

Comment (3): Pg-9 organizational interference needs to be "not filtered"? [11]

Action (3): Information is filtered down within an organization due to requisite variety; some may find the need for more information of which this can be managed by the project lead; i.e. access to more information.

Comment (4): Figure-2 does not define SYS-4 activities. [11]

Action (4): S4 activities are defined in the case study under S4 development; the figure was not intended to describe system level activities, but rather the system itself only.

Comment (5): What is the conclusion/recommendation section of the thesis? [11]

Action (5): The conclusion/recommendation section of the thesis was not to be part of the case study. The case study looked how the VSM could be used to understand the project's PMS. I told him I would send him a copy when the paper was completed.

Comment (6): [0] agreed with model of the project and had grammar and typographical suggestions.

Action (6): Corrected grammar and typographical errors.

Comment (7): [5], [7], and [12] confirmed reading the narrative and had no objections or corrections to report.

Action (7): No action required.

**PROJECT 'T': CASE STUDY FEEDBACK**

Comment (1): Evidence Data with matrix Analysis with Identifiers (portion) figure is not aligned and is not fully displayed. [16]

Action (1): Fixed alignment issue.

Comment (2): Task description for TUMS VoSIP #4 is actually separate tasks as are NVC and Aegis Ashore in #7, while Unified capabilities is an overall architecture verses an individual task as mentioned in the System One development section. [16]

Action (2): Redefined the Systems Ones of the VSM and properly defined the S1's in the Systems One development section and throughout to properly represent S1's.

Comment (3): Table S1 Evidence Item (Portion) from Case Study Database appears to have a formatting issue. [16]

Action (3): Corrected formatting issue.

Comment (4): Table Evidence Item for S3 and S3\*(Portion) from Case Study Database appears to have a formatting issue. [16]

Action (4): Corrected formatting issue.

Comment (5): [5] and [12] concurred with the content and had nothing to add.

Action (5): No action required.

Comment (6): IPT Lead pointed out several figure and table numbering issues, a redundant sentence, and several other typographical errors. IPT Lead concurred with the model's representation of the model as depicted in the case narrative. [00]

Action (6): Corrected typographically and numbering errors.

Comment (7): No comments. [14] Just noted typographical errors. [14]

Action (7): Typographical errors corrected.

Comment (8): "Based on my review of the case study, I thought that the content was on point and reflected reality of how business was conducted on a daily basis here in (deleted). I am interested in reading the final product after you are done editing it. Good luck and let me know if you need anything else!" [20]

Action (8): No action required for case study (send copy of completed work to [20]).

**ACRONYMS**

C (#) - Channels of the Viable System Model, where '#' = number (1-6)

CSR - Case Study Research

MOC - Motor Output Control

OPA - Organizational Process Assets

PM - Project Management (also Project Manager, Program Manager)

PMBOK - Project Management Book Of Knowledge

PMO - Project Management Office

PMP - Project Management Plan

PMS - Project Management Structure; Project Management System

S (#) - Systems (#) of the Viable System Model, where '#' = number (1-5)

SIC - Sensory Input Channel

SME - Subject Matter Expert

VSM - Viable System Model

## GLOSSARY OF TERMS

**Active Project** - an ongoing funded project that is not dormant or in a waiting phase; one that is beyond its initial phase; a project within the operational phase of the project life cycle.

**Algorithm** - a comprehensive set of instructions for reaching a known goal (Beer, 1981, p. 401).

**Analysis** - examining a substance and its components in order to determine their properties and functions, then using the acquired knowledge to make inferences about the whole (Corbin & Strauss, 2008).

**Anastomotic** - the variety of reticulum expected to see in cybernetics; refers to the fact that the many branches of the network intermingle to such purpose that it is no longer possible to sort out quite how the messages traverse the reticulum (Beer, 1981, p.30).

**Autonomous** - a law unto itself; function indicated is responsible for its own regulation (Beer, 1981, p. 103).

**Baseline** - the approved version of a work product that can be changed only through formal change control procedures and is used as a basis for comparison (PMBOK, 2013).

**Coding** - deriving and developing concepts from data; extracting concepts from raw data and developing them in terms of their properties and dimension (Corbin & Strauss, 2008).

**Concepts** - words that stand for groups or classes of objects, events, and actions that share some major common properties, though the properties can vary dimensionally (Corbin & Strauss, 2008).

**Context** - structural conditions that shape the nature of situations, circumstances, or problems to which individuals respond by means of action/ interactions/ emotions (Corbin & Strauss, 2008).

**Control** - comparing actual performance with planned performance, analyzing variances, assessing trends to effect process improvements, evaluating possible alternatives, and recommending appropriate corrective action as needed (PMBOK, 2013).

**Cybernetics** - concerned with the general patterns, laws and principles of behavior that characterize complex, dynamic, probabilistic, integral, and open systems (Clemson, 1984, p. 19) about the manner of control, all kinds of structure, all sorts of systems (Harnden & Leonard, 1994).

**Feedback** - The return of part of a system's output to its input, which is thereby changed. Positive feedback takes an increase in output back to increase the input; negative feedback takes back an output increase to decrease the input – and is therefore stabilizing in principle (Beer, 1981, p. 402).

Feedback Law - “The output of a complex system is dominated by the feedback and, within limits, the input is irrelevant” (Clemson, 1984, p. 28).

Filter - a variety reducer (Beer, 1981, p. 94).

Heuristic - serving to find out; specifies a method of behaving which will tend towards a goal which cannot be precisely specified because we know what it is but not where it is (Beer, 1981, p. 52).

Holistic systems - systems whose important characteristics are not ascertainable from the properties of the system components (Clemson, 1984, p. 26).

Homeostasis - where ever one system impinges on the other, it recognizes a match which is normal to their coexistence (Beer, 1981, p. 145).

Interviews - a formal or informal approach to elicit information from stakeholders by talking to them directly (PMBOK, 2013).

Invariant - a mathematical term; one thing is invariant with respect to something else; it doesn't change as the other thing changes (Beer, 1981, p.87).

Issue - a point or matter in question or dispute, or a point or matter that is not steered and is under discussion or over which there are opposing views or disagreements(PMBOK, 2013) .

Models - are more than analogies; they are meant to disclose the key structure of the system under study; a model is good if it is appropriate (Beer, 1981, p. 75, 84).

OPA - Organizational Process Assets; the plans, processes, procedures, and knowledge basis specific to and used by the performing organization.

Portfolio - projects, programs, sub-portfolios, and operations managed as a group to achieve strategic objectives (PMBOK, 2013).

Process - ongoing responses to problems or circumstances arising out of the context (Corbin & Strauss, 2008). A systematic series of activities directed towards causing and end result such that one or more inputs will be acted upon to create one or more outputs (PMBOK, 2013).

Project - a temporary endeavor undertaken to create a unique product, service, or result (PMBOK, 2013).

Project life cycle - the series of phased that a project passes through from initiation to its closure (PMBOK, 2013).



Project team - A set of individuals who support the project manager in performing the project work to achieve the project's objectives (PMBOK, 2013).

Project Management Plan (PMP) - The document that describes how the project will be executed, monitored, and controlled (PMBOK, 2013).

Qualitative - research questions typically orient to cases or phenomena, seeking patterns of unanticipated as well as expected relationships (Stake, 1995, p. 41). Qualitative research "constructs interpretive narratives from their data and try to capture the complexity of the phenomenon under study" (Leedy & Ormrod, 2010, p. 97). For qualitative research, the focus on the interrelationships of the issues illustrates the importance that case study research can have on explaining the context of the subject of the research.

Quantitative - research question seeks out a relationship between small numbers of variables (Stake, 1995, p. 37).

Properties - characteristics that define and describe concepts (Corbin & Strauss, 2008).

Regulation - to select certain results from those that are possible (Clemson, 1984, p. 70).

Requirements - a condition or capability that is required to be present in a product, service, or result to satisfy a contract or other formally imposed specification (PMBOK, 2013).

Requisite Variety Law - Given a system and some regulator of that system, the amount of regulation attainable is absolutely limited by the variety of the regulator" (Clemson, 1984, p. 36).

Resource - skilled human resources (specific disciplines whether individually or in crews or teams), equipment, services, supplies, commodities, materials, budgets, or fund (PMBOK, 2013).

Risk - an uncertain event or condition that, if it occurs, has a positive or negative effect on one or more project objectives (PMBOK, 2013).

Role - a defined function to be performed by a project team member, such as testing, filing, inspecting, or coding (PMBOK, 2013).

Saturation - when no additional data are being found whereby the researcher can develop properties of the category (Glaser & Strauss, 2010).

Scope - The sum of the products, services, and results to be provided as a project (PMBOK, 2013).

Self-Organizing Systems Principle - "Complex systems organize themselves; the characteristic structural and behavior patterns in a complex system are primarily a result of the interactions among the system parts" (Clemson, 1984, p. 26).

Sensorium - anything within a system that can register and classify the existence of a stimulus (Beer, 1981, p. 28).

SIC - Sensory Input Channel.

Stakeholder - an individual, group, organization who may affect, be affected by, or perceive itself to be affected by a decision, activity, or outcome of a project.

State - of the system is defined as a particular allocation of forms to events, given a particular configuration of events (Beer, 1981, p. 144).

Statement Of Work (SOW) - A narrative description of product, services, or results to be delivered by the project (PMBOK, 2013).

Variance - a quantifiable deviation, departure, or divergence away from a known baseline or expected value (PMBOK, 2013).

Variety - The total number of possible states of a system, or an element of a system (Beer, 1981, p.403). The measure of the “number of possible states of whatever it is whose complexity we want to measure” (Beer, 1979, p. 23). The technical expression for complexity of the systems or the number of states a system may have.

Viability Principle - the ability of a system to maintain a separate existence and depends on a number of necessary conditions (Beer, 1979, p. 199).

Work Breakdown Structure (WBS) - a hierarchical decomposition of the total scope of work to be carried out by the project team to accomplish the project objectives and create the required deliverables (PMBOK, 2013).

### VMS TO PMBOK PMS ANALYSIS MATRIXES DATA

Project Management Structure	Section	VSM Structure												
		S1	S2	S3	S3*	S4	S5	C1	C2	C3	C4	C5	C6	Alg
Chapter 1	Intro													
	1.1					1	1			1	1	1		1
	1.2	1				1	1			1	1	1		
	1.3		2	3		3	3	1		2	2	2	1	
	1.4					2	2	2		2	2	1	1	
	1.5			1		2	2			2	2	2	1	1
	1.6									1	1			
	1.7			1		2	3	1	2	2	2	2	1	
	1.8						1							
3 present				y		y	Y							
qty of 3				1		1	2							
2 present			y			y	Y	Y	y	y	y	y		
qty of 2			1			3	3	1	1	3	4	3		

**Table 93: Chapter 1 VSM to PMBOK PMS Analysis Matrix**

Project Management Structure	Section	S1	S2	S3	S3*	S4	S5	C1	C2	C3	C4	C5	C6	Alg
Chapter 2	Intro													
	2.1	3	1	2	3	3	3	2	2	3	3	2	2	
	2.2	3	1	3	2	2	3	3	2	2	2	1	2	1
	2.3	3	1	3	1	2	3	2	2	3	3	2	1	
	2.4	2	1	2	2	3	1	2	2	3	3	2	2	
3 present		Y		Y	y	Y	Y	Y		Y	Y			
qty of 3		3		2	1	2	3	1		3	3			
2 present		y		y	y	y		Y	y	y	y	y	y	
qty of 2		1		2	2	2		3	4	1	1	3	3	

**Table 64: Chapter 2 VMS to PMBOK PMS Analysis Matrix**

Project Management Structure	Section	VSM Structure												
		S1	S2	S3	S3*	S4	S5	C1	C2	C3	C4	C5	C6	Alg
Chapter 3	Intro													
	3.1		1	1	2	1	1		1	1	1	1	2	
	3.2					1	1			1	1	1	1	
	3.3	1	1	2	1	2	3	1	1	2	2	1	1	
	3.4	1	1	2	1	2	2	1	1	2	2	1	1	
	3.5			1		1	1			1	1	1		
	3.6	2	2	2	2	2	1	2	2	2	2	1	2	
	3.7	2		2		2	2	2		1	1	1	2	
	3.8	2	1	2	2	2	1	1	2	2	1	1	2	
	3.9					2	1							
3 present							Y							
qty of 3							1							
2 present		y	y	y	y	y	Y	y	y	y	y		y	
qty of 2		3	1	5	3	6	2	2	2	4	3		4	

**Table 65: Chapter 3 VSM to PMBOK PMS Analysis Matrix**

Project Management Structure	Section	VSM Structure												
		S1	S2	S3	S3*	S4	S5	C1	C2	C3	C4	C5	C6	Alg
Chapter 4	Intro													
	4.1	2	2	3	2	2	3	2	2	3	3	2	2	
	4.2	3	3	3	3	3	3	2	3	3	3	3	3	
	4.3	3	2	3	3	3	3	3	3	3	3	3	3	
	4.4	2	2	2	2	2	2	1	2	3	3	3	2	2
	4.5	2	2	2	2	2	2	2	1	3	3	3	2	
	4.6	2	1	2	2	2	2	2	2	2	2	2	2	
3 present		y	y	y	y	y	Y	y	y	y	y	y	y	
qty of 3		2	1	3	2	2	3	1	2	5	5	4	2	
2 present		y	y	y	y	y	Y	y	y	y	y	y	y	Y
qty of 2		4	4	3	4	4	3	4	3	1	1	2	4	1

**Table 66: Chapter 4 VSM to PMBOLK PMS Analysis Matrix**

Project Management Structure	Section	VSM Structure												
		S1	S2	S3	S3*	S4	S5	C1	C2	C3	C4	C5	C6	Alg
Chapter 5	Intro													
	5.1			1	1	2	2			2	2	1	1	
	5.2	1	1	2	1	2	2	2	1	2	2	1	1	
	5.3	1		2	1	1	2	2	2	2	2	1	1	
	5.4	3	1	3	1	2	2	2	3	2	3	1	1	
	5.5	3	1	3	3	2	1	2	3	3	3	1	3	
	5.6	3		3	3	2	1		3	3	3	1	3	
3 present		y		y					y	y	y		y	
qty of 3		3		3	2				3	2	3		2	
2 present				y		y	Y	y	y	y	y			
qty of 2				2		5	4	4	1	4	3			

**Table 67: Chapter 5 VSM to PMBOK PMS Analysis Matrix**

Project Management Structure	Section	VSM Structure												
		S1	S2	S3	S3*	S4	S5	C1	C2	C3	C4	C5	C6	Alg
Chapter 6	Intro													
	6.1	1	2	2	2	2	2		2	3	3	1	1	
	6.2	3	2	3	1	2			3	3	3	1	1	
	6.3	3	2	3	1	3			3	3	3	1	2	
	6.4	3	1	3	1	3	1	1	3	3	3	2	2	
	6.5	3	1	3	1	3	1	1	3	3	2	2	2	
	6.6	3	1	3	1	3	2	1	3	3	2	2	2	
	6.7	3	1	3	1	3	2	1	3	3	2	2	2	
3 present		y		y		y			y	y	y			
qty of 3		6		6		5			6	7	4			
2 present			y	y	y	y	Y		y		y	y	y	
qty of 2			3	1	1	2	3		1		3	4	5	

**Table 68: Chapter 6 VSM to PMBOK PMS Analysis Matrix**

Project Management Structure	Section	VSM Structure												
		S1	S2	S3	S3*	S4	S5	C1	C2	C3	C4	C5	C6	Alg
Chapter 7	Intro													
	7.1	2	1	2	1	3	1	1	2	2	2	1	2	
	7.2	2	1	2	1	3	1	1	2	2	2	1	2	
	7.3	3	1	2	2	3	2	1	2	2	3	2	2	
	7.4	2	2	3	3	3	2	2	3	3	3	3	3	
3 present		y		y	y	y			y	y	y	y	y	
qty of 3		1		1	1	4			1	1	2	1	1	
2 present		y	y	y	y		Y	y	y	y	y	y	y	
qty of 2		3	1	3	1		2	1	3	3	2	1	3	

**Table 69: Chapter 7 VSM to PMBOK PMS Analysis Matrix**

Project Management Structure	Section	VSM Structure											Alg	
		S1	S2	S3	S3*	S4	S5	C1	C2	C3	C4	C5		C6
Chapter 8	Intro													
	8.1	3	2	3	3	2	1	1	3	3	3	2	3	
	8.2	2	2	3	3	3	1	1	3	2	2	2	3	
	8.3	2	2	3	3	3	1	1	3	2	2	2	3	
3 present		y		y	y	y			y	y	y		y	
qty of 3		1		3	3	2			3	1	1		3	
2 present		y	y			y				y	y	y		
qty of 2		2	2			1				2	2	3		

**Table 70: Chapter 8 VSM to PMBOK PMS Analysis Matrix**

Project Management Structure	Section	VSM Structure											Alg
		S1	S2	S3	S3*	S4	S5	C1	C2	C3	C4	C5	
Chapter 9	Intro												
	9.1	3	2	3	2	3	2	1	2	3	3	1	1
	9.2	3	2	3	2	3	2	1	2	3	3	1	1
	9.3	3	2	3	3	3	3	2	3	3	3	2	2
	9.4	3	2	3	2	2	3	2	3	3	3	3	3
3 present		y		y	y	y	y		y	y	y	y	y
qty of 3		4		4	1	4	2		2	4	4	1	1
2 present			y		y	y	y	y	y			y	y
qty of 2			4		3	1	2	2	2			1	1

**Table 71: Chapter 9 VSM to PMBOK PMS Analysis Matrix**

Project Management Structure	Section	VSM Structure												
		S1	S2	S3	S3*	S4	S5	C1	C2	C3	C4	C5	C6	Alg
Chapter 10	Intro													
	10.1	3	2	3	2	3	3	2	3	3	3	2	2	
	10.2	3	2	3	2	3	3	1	3	3	3	2	2	
	10.3	3	2	3	2	2	3	1	3	3	3	2	2	
3 present		y		y		y	Y		y	y	y			
qty of 3		3		3		2	3		3	3	3			
2 present			y		y	y		y				y	y	
qty of 2			3		3	1		1				3	3	

**Table 72: Chapter 9 VSM to PMBOK PMS Analysis Matrix**

Project Management Structure	Section	VSM Structure												
		S1	S2	S3	S3*	S4	S5	C1	C2	C3	C4	C5	C6	Alg
Chapter 11	Intro													
	11.1	2	1	2	1	2	1	1	2	2	2	1	2	
	11.2	2	2	2	2	3	2	1	2	2	2	1	2	
	11.3	2	1	2	2	3	2	1	2	2	2	1	2	
	11.4	2	1	2	2	3	2	1	2	2	2	1	2	
	11.5	2	1	3	2	3	2	1	1	2	2	1	2	
	11.6	3	1	3	3	3	2	1	2	3	3	1	3	
3 present		y		y	y	y				y	y		y	
qty of 3		1		2	1	5				1	1		1	
2 present		y	y	y	y	y	Y		y	y	y		y	
qty of 2		5	1	4	4	1	5		5	5	5		5	

**Table 73: Chapter 11VSM to PMBOK PMS Analysis Matrix**



Project Management Structure	Section	VSM Structure												
		S1	S2	S3	S3*	S4	S5	C1	C2	C3	C4	C5	C6	Alg
Chapter 12	Intro													
	12.1	3	1	3	3	3	3	2	3	3	3	2	3	
	12.2	3	1	3	3	3	3	3	3	3	3	1	3	
	12.3	3	1	3	3	3	3	3	3	3	3	1	3	
	12.4	2	2	2	3	3	2	3	2	3	3	1	3	
3 present		y		y	y	y	Y	y	y	y	y		y	
qty of 3		3		3	4	4	3	4	3	4	4		4	
2 present		y	y	y			Y	y	y			y		
qty of 2		1	1	1			1	1	1			1		

**Table 74: Chapter 12 VSM to PMBOK PMS Analysis Matrix**

Project Management Structure	Section	VSM Structure												
		S1	S2	S3	S3*	S4	S5	C1	C2	C3	C4	C5	C6	Alg
Chapter 13	Intro													
	13.1	2	1	2	1	2	3	3	1	2	2	1	1	
	13.2	3	1	3	1	3	3	2	3	3	3			
	13.3	2	1	2	1	3	3	3	1	3	3	1		
	13.4	2	1	3	2	3	3	2	3	3	3	2		
3 present		y		y		y	Y	y	y	y	y			
ty of 3		1		2		3	3	2	2	3	3			
2 present		y		y	y	y		y		y	y	y		
qty of 2		3		2	1	1		2		1	1	1		

**Table 75: Chapter 13 VSM to PMBOK PMS Analysis Matrix**

Chapters ('3' answered)	S1	S2	S3	S3*	S4	S5	C1- Envir	C2- S1s	C3- Corp	C4- Barg	C5- Osc	C6- Audi	Alg
1			1		1	2							
2	3		2	1	2	3	1		3	3			
3						1							
4	2	1	3	2	2	3	1	2	5	5	4	2	
5	3		3	2				3	2	3		2	
6	6		6		5			6	7	4			
7	1		1	1	4			1	1	2	1	1	
8	1		3	3	2			3	1	1		3	
9	4		4	1	4	2		2	4	4	1	1	
10	3		3		2	3		3	3	3			
11	1		2	1	5				1	1		1	
12	3		3	4	4	3	4	3	4	4		4	
13	1		2		3	3	2	4	2	3	3		
Overall Summation	28	1	33	15	34	20	8	27	33	33	9	14	0

Chapters ('2's answered)	S1	S2	S3	S3*	S4	S5	C1- Envir	C2- S1s	C3- Corp	C4- Barg	C5- Osc	C6- Audi	Alg
1		1			3	3	1	1	3	4	3		
2	1		2	2	2		3	4	1	1	3	3	
3	3	1	5	3	6	2	2	2	4	3		4	
4	4	4	3	4	4	3	4	3	1	1	2	4	1
5			2		5	4	4	1	4	3			
6		3	1	1	2	3		1		3	4	5	
7	3	1	3	1		2	1	3	3	2	1	3	
8	2	2			1				2	2	3		
9		4		3	1	2	2	2			1	1	
10		3		3	1		1				3	3	
11	5	1	4	4	1	5		5	5	5		5	
12	1	1	1			1	1	1			1		
13	3		2	1	1		2		1	1	1		
Overall Summation	22	21	23	22	27	25	21	23	24	25	22	28	1

**Table 76: VSM to PMBOK PMS Analysis Matrixes Summations**

## CASE STUDY DATABASE EXCERPT AND SOURCE CODING

As part of the case study protocol a case study database was created to capture data from the source and be able to have traceability back to the source for the evidence items used in the case study narrative. Below in Table 71 is an excerpt of the table:

9	Continues to discuss future upcoming events with group	01-01-00-003-05-16-16
10	How are scheduling items determined	01-01-00-003-05-16-16
11	How are updates managed? When government reps say add an item consensus is discussed and then item is added or modified	01-01-00-003-05-16-16
12	Contract [2] continues to follow agenda and leads the meeting	01-01-00-003-05-16-16
13	Logistics [1] asks clarification from [7] on dates and tasks	01-01-00-003-05-16-16
14	Discussion on upcoming potential task	01-01-00-003-05-16-16
15	Discussion of other projects task completion dates as their task depend on the completion of these others. Logistics [2] seemed to have the most knowledge of the others task schedules	01-01-00-003-05-16-16
16	"Who/How is scheduling data provided? By whose direction?"	01-01-00-003-05-16-16

**Table 77: Case Study Database Excerpt**

The Source code from left-to-right (xx-xx-xx-xxx-xx-xx-xx) is defined as below:

Evidence number = xx-xx-xx-xxx-xx-xx-xx

XX - The project the data is associated with for example:

3. '01' is Project 'Q'
4. '02' is Project 'T'

XX - The type of data source, for example:

5. '00' Document from email
6. '01' Meeting
7. '02' Discussion
8. '03' Observation

XX – Who/the source; the person or project name; used to protect identity for anonymity.

XXX- Artifact Number, Data Source Item.

XX-XX-XX – Last six are the date based on two digit month-day-year

## VITA

Joseph A. Sisti was born in Massapequa, New York on July 29, 1964 and raised in Smithfield, VA since he was eight. His educational background includes a B.S. degree in Electrical Engineering from Old Dominion University, Norfolk, VA (1988) and a M.E.M. degree in Engineering Management from Old Dominion University, Norfolk, VA (2002). Upon completion of his undergraduate studies he held several different project management positions over the past 29 years within the SPAWAR Atlantic organization. Currently he has been assigned to the position of Sub-Portfolio Lead for the Navy Afloat Transport Systems Sub-Portfolio since 2014.